

Opportunities in the Fusion Energy Sciences Program

Appendix C Topical Areas Characterization

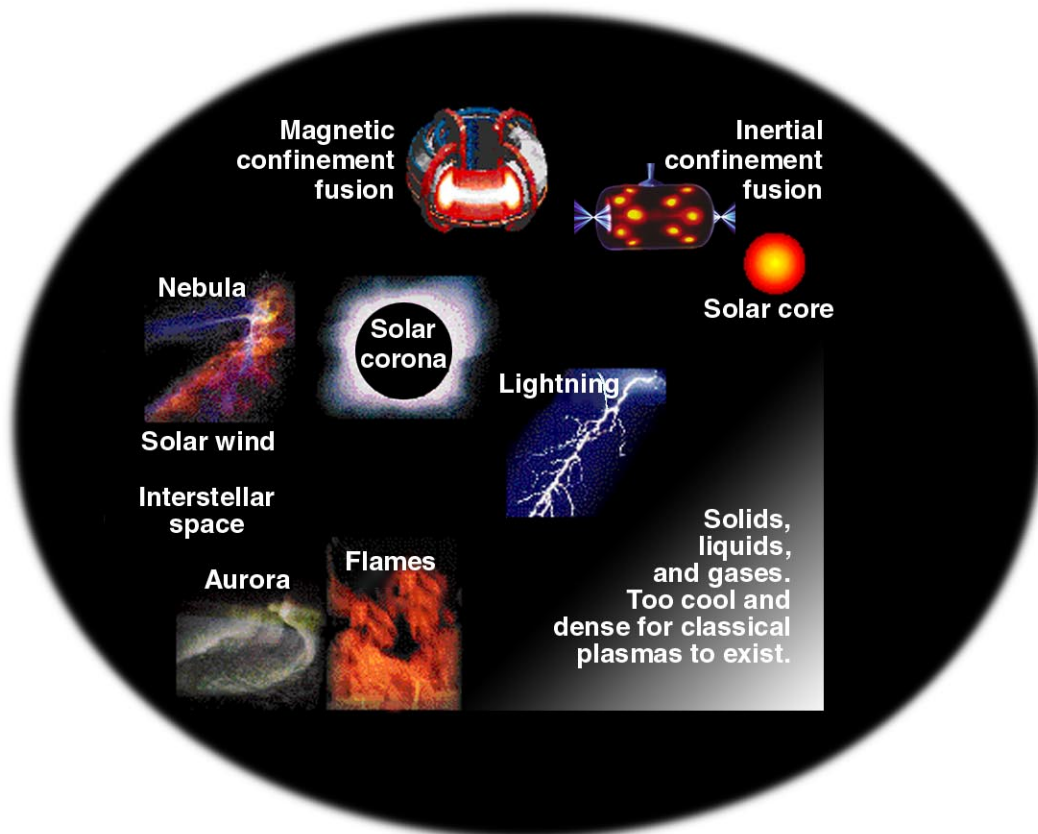

Prepared by the
Fusion Energy Sciences Advisory Committee
for the
Office of Science of the U.S. Department of Energy

Cover design adapted with permission of the Contemporary Physics Education Project from the wall chart "Fusion—Physics of a Fundamental Energy Source" (<http://FusEdWeb.pppl.gov/CPEP/chart.html>).

OPPORTUNITIES IN THE FUSION ENERGY SCIENCES PROGRAM

Appendix C TOPICAL AREAS CHARACTERIZATION

June 1999

Prepared by
the Fusion Energy Sciences Advisory Committee
for the Office of Science of the U.S. Department of Energy

On the World Wide Web:
http://www.fofe.er.doe.gov/More_HTML/FESAC_Charges_Reports.html

PREFACE

This document has been prepared in response to a charge to the Fusion Energy Sciences Advisory Committee (FESAC) from Dr. Martha Krebs, Director of the Department of Energy's Office of Science:

... to make final a program plan for the fusion energy science program by the end of 1999 (FY). Such a program plan needs to include paths for both energy and science goals taking into account the expected overlap between them. The plan must also address the needs for both magnetic and inertial confinement options. It will have to be specific as to how the U.S. program will address the various overlaps, as well as international collaboration and funding constraints. Finally, this program plan must be based on a 'working' consensus (not unanimity) of the community, otherwise we can't move forward. Thus I am turning once again to FESAC.

I would like to ask FESAC's help in two stages. First, please prepare a report on the opportunities and the requirements of a fusion energy science program, including the technical requirements of fusion energy. In preparing the report, please consider three time-scales: near-term, e.g., 5 years; mid-term, e.g., 20 years; and the longer term. It would also be useful to have an assessment of the technical status of the various elements of the existing program. This document should not exceed 70 pages and should be completed by the end of December 1998, if at all possible. I would expect to use this work, as it progresses, as input for the upcoming SEAB review of the magnetic and Inertial Fusion Energy Programs.

A FESAC Panel was set up to prepare the document. The Panel decided to follow the approach used in the preparation of the reports from the Yergin Task Force on Strategic Energy Research and Development of June 1995 and from the National Laboratory Directors on Technology Opportunities to Reduce U.S. Greenhouse Gas Emissions of October 1997. As a first step, a two-page description of each of the main topical areas of fusion energy sciences was obtained from key researchers in that area. The descriptions give the status and prospects for each area in the near-term, midterm, and longer term, discussing both opportunities and issues. These two-pagers are published as a separate report. The two-pagers were used as background information in the preparation of this overview, *Opportunities in Fusion Energy Sciences Program*. FESAC thanks all of those who participated in this work.

CONTENTS

	Page
C.1 AUTHOR LIST	1
C.2 MAGNETIC FUSION ENERGY (MFE)	3
M-1 Stellarator	6
M-2 Compact Stellarator.....	8
M-3 Tokamak	10
M-4 Advanced Tokamak	12
M-5 Electric Tokamak	14
M-6 Spherical Torus	16
M-7 Reversed-Field-Pinch Concept.....	18
M-8 Spheromak.....	20
M-9 Field-Reversed Configuration	22
M-10 Levitated Dipole Fusion Concept.....	24
M-11 Open-Ended Magnetic Fusion Systems	26
M-12 Gas Dynamic Trap	28
M-13 Plasmas with Strong External Drive.....	30
M-14 Magnetized Target Fusion	32
M-15 Boundary Plasma/Wall Interactions	34
M-16 Burning Plasma Science	36
M-17 Burning Plasma Experimental Options	38
M-18 Integrated Fusion Science and Engineering Technology Research	40
M-19 Volumetric Neutron Source	42
M-20 Advanced Fuels.....	44
C.3 INERTIAL FUSION ENERGY (IFE)	47
I-1 National Ignition Facility.....	50
I-2 Indirect-Drive Inertial Fusion Energy	52
I-3 Direct-Drive Inertial Fusion Energy.....	54
I-4 Fast Ignition Approach to Inertial Fusion Energy	56
I-5 Heavy Ion Accelerators for Fusion.....	58
I-6 Repetition-Rate Krypton Fluoride Laser.....	60
I-7 Solid-State Laser Drivers.....	62
I-8 Laser and Plasma Interactions	64
I-9 Pulsed Power.....	66
I-10 Target Design and Simulations.....	68
I-12 Final Optics—Laser IFE.....	70
I-13 Laser-Driven Neutron Sources	72
C.4 PLASMA AND FUSION TECHNOLOGIES.....	75
T-1 Superconductivity.....	78
T-2 Electromagnetic Heating and Current Drive.....	80
T-3 Neutral Beams	82
T-4 Fueling and Vacuum	84
T-5 Divertor.....	86
T-6 High Heat Flux Components and Plasma Materials Interactions.....	88
T-7 MFE Liquid Walls.....	90
T-8 Shield/Blanket	92
T-9 Radiation-Resistant Materials Development.....	94
T-10 International Fusion Materials Irradiation Facility	96

T-11	Tritium Systems	98
T-12	Remote Maintenance.....	100
T-13	MFE Safety and Environment	102
T-14	IFE Safety and Environment.....	104
T-15	IFE Liquid-Wall Chambers	106
T-16	Dry Wall Chambers.....	108
T-17	IFE Target Fabrication	110
T-18	IFE Target Injection and Tracking	112
T-19	IFE Power Plant Technologies	114
T-20	Advanced Design Studies	116
C.5	PLASMA SCIENCE.....	119
S-1	Hamiltonian Dynamics	122
S-2	Long Mean-Free Path Physics.....	124
S-3	Wave-Particle Interactions.....	126
S-4	Turbulence.....	128
S-5	Hydrodynamics and Turbulence.....	130
S-6	Dynamo and Relaxation.....	132
S-7	Magnetic Reconnection	134
S-8	Dense Matter Physics.....	136
S-9	Nonneutral Plasmas.....	138
S-10	Electrostatic Traps.....	140
S-11	Atomic Physics.....	142
S-12	Opacity in ICE/IFE	144
S-13	MFE Plasma Diagnostics.....	146
S-14	IFE Diagnostics.....	148
S-15	Advanced Computation	150
S-16	Computer Modeling of Plasma Systems	152
S-17	Astrophysics Using Fusion Facilities	154
C.6	NEAR-TERM COMMERCIAL APPLICATIONS.....	157
N-1	Semiconductors	158
N-2	Advanced Materials Processing and Manufacturing	160
N-3	Environment	162
N-4	Medical Applications	164
N-5	Plasma Propulsion.....	166
	LIST OF ACRONYMS.....	169

C.1 AUTHOR LIST

M. Abdou, UCLA
D. Anderson, U. of Wisconsin
H. Baldis, LLNL
R. Bangerter, LBNL
J. Barnard, LLNL
D. Barnes, LANL
I. Bernstein, Yale U.
A. Bhattacharjee, PPPL
E. Bloom, ORNL
S. Bodner, NRL
A. Boozer, Columbia U.
L. Bromberg, MIT
B. Carreras, ORNL
V. Chan, GA
B. Chapman, U. of Wisconsin
R. Cohen, LLNL
S. Cohen, PPPL
G. Collins, LLNL
J. Conrad, U. of Wisconsin
D. Craig, U. of Wisconsin
A. DaSilva, U. of Maryland
L. Da Silva, LLNL
R. Davidson, PPPL
J. Dawson, UCLA
J. Degnan, AFRL
D. Den Hartog, U. of Wisconsin
J. Drake, U. of Maryland
G. Dunn, U. of Colorado
A. Faltens, LBNL
G. Fiksel, U. of Wisconsin
N. Fisch, PPPL
A. Friedman, LLNL
D. Garnier, Columbia U.
K. Gentle, U. of Texas
G. Glendinning, LLNL
R. Goldston, PPPL
D. Goodin, GA
M. Gouge, ORNL
H. Griem, U. of Maryland
R. Hazeltine, U. of Texas
C. Hegna, U. of Wisconsin
D. Hill, LLNL
A. Hoffman, U. of Washington
B. Hooper, LLNL
J. Hosea, PPPL
W. Houlberg, ORNL
I. Hutchinson, MIT
T. James, UCSD
H. Ji, PPPL
J. Johnson, Florida A&M
J. Johnson, PPPL
J. Kesner, MIT
H. Khater, U. of Wisconsin
R. Kirkpatrick, LANL
S. Krasheninnikov, MIT
W. Kruer, LLNL
J. Kwan, LBNL
B. LaBombard, MIT
N. Lanier, U. of Wisconsin
J. Latkpwski, LLNL
E. Lee, LBNL
M. Lieberman, U. of Berkeley
I. Lindemuth, LANL
B. Lipschultz, MIT
G. Logan, LLNL
J. Lyon, ORNL
E. Marmor, MIT
K. Matzen, SNL
M. Mauel, Columbia U.
D. Meade, PPPL
W. Meier, LLNL
M. Menon, ORNL
F. Meyer, ORNL
W. Miller, GA
J. Minervini, MIT
P. Mioduszewski, ORNL
R. Moir, LLNL
A. Molvik, LLNL
H. Monkhorst, U. of Florida
F. Najmabadi, UCSD
G. Neilson, PPPL
C. Olson, SNL
S. Payne, LLNL
M. Peng, ORNL
F. Perkins, PPPL
J. Perkins, LLNL
J. Peterson, LLNL
P. Peterson, U. of Cal., Berkeley
R. Petrasso, MIT
D. Petti, INEEL
R. Petzoldt, U. of Cal., Berkeley
C. Phillips, PPPL
R. Post, LLNL
H. Powell, LLNL
S. Prager, U. of Wisconsin
D. Rasmussen, ORNL
B. Remington, LLNL
M. Rosen, LLNL
N. Rostoker, U. of Cal., Irvine
P. Rutherford, PPPL
D. Ryutov, LLNL
M. Saltmarsh, ORNL
J. Santarius, U. of Wisconsin
J. Sarff, U. of Wisconsin
K. Schoenberg, LANL
D. Schultz, ORNL
K. Schultz, GA
W. Seka, U. of Rochester
J. Sethian, NRL
T. Shannon, U. of Tennessee
J. Sheffield, ORNL
R. Siemon, LANL
T. Simonen, GA
C. Skinner, PPPL
D. Smith, ANL
W. Stacey, Georgia Tech.
R. Stambaugh, GA
C. Surko, UCSD
I. Sviatoslavsky, U. of Wisconsin
D. Swain, ORNL
M. Tabak, LLNL
J. Talmadge, U. of Wisconsin
W. Tang, PPPL
R. Taylor, UCLA
R. Temkin, MIT
K. Thomassen, LLNL
M. Tillack, UCSD
N. Uckan, ORNL
E. Uchimoto, U. of Montana
M. Ulrickson, SNL
C. Verdon, U. of Rochester
S. Willms, LANL
P. Woskov, MIT
K. Young, PPPL
M. Zarnstorff, PPPL
S. Zweben, PPPL

Table C.1. Topical areas in fusion energy sciences^{a,b}

No.	MFE M-1 to M-20	IFE I-1 to I-12	Technologies T-1 to T-20	Plasma Science S-1 to S-17	Near-Term Applications N-1 to N-5
1	Stellarator	National Ignition Facility	Superconductivity	Hamiltonian Dynamics	Semiconductors
2	Compact Stellarator	Indirect-Drive Inertial Fusion Energy	Electromagnetic Heating and Current Drive	Long Mean-Free Path Physics	Advanced Materials Processing and Manufacturing
3	Tokamak	Direct-Drive Inertial Fusion Energy	Neutral Beams	Wave-Particle Interactions	Environment
4	Advanced Tokamak	Fast Ignition Approach to Inertial Fusion Energy	Fueling and Vacuum	Turbulence	Medical Applications
5	Electric Tokamak	Heavy Ion Accelerators for Fusion	Divertor	Hydrodynamics and Turbulence	Plasma Propulsion
6	Spherical Torus	Repetition-Rate Krypton Fluoride Laser	High Heat Flux Components and Plasma Materials Interactions	Dynamo and Relaxation	
7	Reversed-Field-Pinch Concept	Solid-State Laser Drivers	MFE Liquid Walls	Magnetic Reconnection	
8	Spheromak	Laser and Plasma Interactions	Shield/Blanket	Dense Matter Physics	
9	Field-Reversed Configuration	Pulsed Power	Radiation-Resistant Materials Development	Nonneutral Plasmas	
10	Levitated Dipole Fusion Concept	Target Design and Simulations	International Fusion Materials Irradiation Facility	Electrostatic Traps	
11	Open-Ended Magnetic Fusion Systems	Final Optics—Laser IFE	Tritium Systems	Atomic Physics	
12	Gas Dynamic Trap	Laser-Driven Neutron Sources	Remote Maintenance	Opacity in ICE/IFE	
13	Plasmas with Strong External Drive		MFE Safety and Environment	MFE Plasma Diagnostics	
14	Magnetized Target Fusion		IFE Safety and Environment	IFE Diagnostics	
15	Boundary Plasma/Wall Interactions		IFE Liquid-Wall Chambers	Advanced Computation	
16	Burning Plasma Science		Dry Wall Chambers	Computer Modeling of Plasma Systems	
17	Burning Plasma Experimental Options		IFE Target Fabrication	Astrophysics Using Fusion Facilities	
18	Integrated Fusion Science and Engineering Technology Research		IFE Target Injection and Tracking		
19	Volumetric Neutron Source		IFE Power Plant Technologies		
20	Advanced Fuels		Advanced Design Studies		

^aNote that the upper seven technologies are for MFE, the lower ones for IFE, and the middle seven and the last one can apply to both.

^bNote that single-pulse laser driver development for IFE has traditionally been supported primarily by the ICF program within the DP element of DOE. A key issue for IFE is the development of repetitively pulsed drivers.

C.2 MAGNETIC FUSION ENERGY (MFE)

The diagram of a reference tokamak power plant in Fig. C.1 shows the key components of a typical magnetic fusion power plant.

- The characteristics of potential magnetic configurations are given in M-1 through M-14. As discussed in Sect. 2.2 of the main document, these configurations fall into two main categories: externally controlled and self-ordered plasmas.
- Plasma wall interactions and divertors to handle particle and heat removal and impurity control are discussed in M-15 and T-5, respectively.
- Burning plasma physics and opportunities for burning plasma experiments are discussed in M-16 and M-17, respectively. International Thermonuclear Experimental Reactor (ITER) scale facilities are discussed in M-18.

The plasma, nuclear, and safety technologies are shown, respectively, in T-1 to T-6, T-7 to T-12, and T-13 and T-14. Power plants are discussed in T-20.

A power plant that burns plasma will need to achieve a value of the product (density) \times (ion temperature) \times (energy confinement time) of $\langle n_D T_i \rangle \tau \approx 2 \times 10^{24} \text{ (m}^{-3} \cdot \text{eV} \cdot \text{s)}$ for a deuterium-tritium (D-T) plasma, at an ion temperature of $\sim 10 \text{ keV}$, and $\langle n_D T_i \rangle \tau > 2 \times 10^{25} \text{ (m}^{-3} \cdot \text{eV} \cdot \text{s)}$ for a D-D or D- ^3He plasma of 30 keV . A temperature of $1 \text{ eV} \approx 10,000 \text{ K}$.

The energy confinement time (τ) is defined as the energy in the plasma divided by the power required to keep it hot. Another commonly used parameter is beta (β), the ratio of the plasma pressure to the magnetic pressure $\beta \propto nT/B^2$, where B is the magnetic field.

The magnetic field of most of the configurations being studied has two main components: a toroidal field (B_t) (going the long way around the torus) and a poloidal field (B_p) (going the short way around the torus), as shown in Fig. C.2. The safety factor, q , is the amount of twist of the helical magnetic field lines (the number of toroidal field-line transits per poloidal field-line transit), and $q = r B_t / R B_p$, if $\beta \ll 1$, $a/R \ll 1$, where r and R are the minor and major radii of the torus, respectively [the outer plasma minor radius is denoted by (a)]. For the case of stellarators, it is convention to use the parameter iota bar, $\nu/2\pi = 1/q$ to describe the twist in the total field. The parameters (κ) and (δ) are used, respectively, to describe the ellipticity and triangularity of noncircular plasma cross sections.

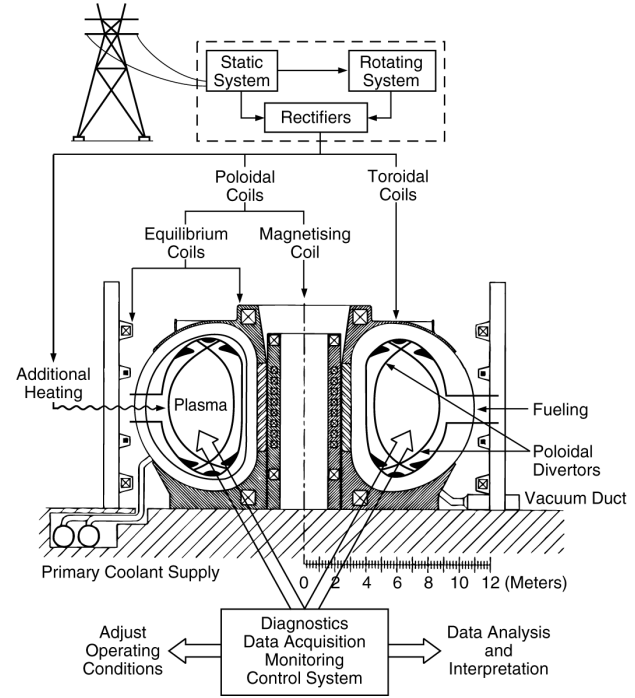

Fig. C.1. Representative tokamak.

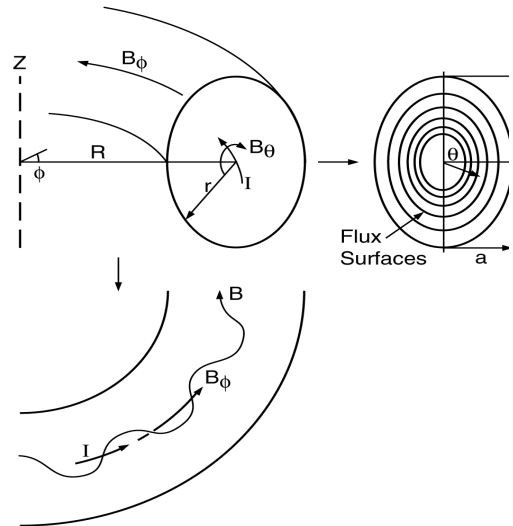

Fig. C.2. Toroidal and poloidal fields.

Table C.2. MFE experiments, operational or construction (major international)

Experiment	R (m)	a (m) [κ]	Pulse length (s)	B _t (T) [B _p (T)]	I (MA)	P _{heat} (MW)	Div-ertor?	T _i (0) (keV) [T _e (0)]	<n> 10 ²⁰ m ⁻³	τ (s)	β (%)
External control						Stellarator⁽¹⁾					
HSX (Wisconsin)	1.2	0.15	0.2	1.37	N.A.	0.2	No	Operate 1999			
W7-AS (Germany)	2.0	0.18	3	2.5	N.A.	3	Yes	1.5	3	0.05	2
TJ-II (Spain)	1.5	0.22	0.5	1.2	N.A.	2	No	Start of operation			
LHD (Japan)	3.9	0.6	St. St.	4	N.A.	40	Yes	Start of operation			
CHS (Japan)	1.0	0.2	0.74	2	N.A.	1.7	Yes	1	0.8	0.01	2.1
Heliotron J (Japan)	1.2	0.17	0.2	1.5	N.A.	2	No	Construction			
W7-X (Germany)	5.5	0.52	St. St.	3	N.A.	30	Yes	Construction			
External control						Advanced tokamak (AT)					
Alcator C-Mod	0.67	0.22 [1.8]	2 (7)	9	1.5 (2.5)	8	Yes	6 (10)	10	0.09 (0.2)	1.5 (5)
D-IIID	1.67	0.67 [2.5]	10	2.2	3	27	Yes	27	3	0.5	13
HBT-EP	0.92	0.15 [1.0]	0.02	0.4	0.02	0.2	No	0.2	0.2	0.001	1.5–3
ET	5	1 [1.5]	0.1	0.5	0.2	2	No	2	0.1	0.1	3
ASDEX-U (Germany)	1.65	0.5 [1.6]		3	1.6	27	Yes				
FT-U (Italy)	0.93	0.3 [1.0]		8	1.3	7	No				
JET (ECC)	3	1.25 [1.8]	60	40	7	42	Yes	40	0.8	1.8	4
Textor (Germany)	1.75	0.46 [1.0]		3	0.8	8	No				
Tore Supra (France)	2.47	0.8 [1.0]		4.5	1.7	9	No				
JRT2-M (Japan)	1.31	0.35 [1.7]		2.2	0.25		Yes				
JT-60 (Japan)	3.3	0.8 [1.8]	10	4.4	5	55	Yes	45	1	1	1.7
Triam-1M (Japan)	0.8	0.12 [1.5]	7200	8	0.4	0.2	Yes	5	0.1	0.01	
K-Star (Korea)	1.8	0.5 [2]	20–300	3.5	2	15–40	Yes	Design/Construction			
Intermediate						Spherical torus (ST)					
HIT-I (Shutdown)	0.3	0.2 [1.85]	0.01	0.5	0.25		Yes		0.6		
START (UK) (Shutdown)	0.32	0.25 [1.8–3]	0.05	0.3	0.31	1	Yes	0.35	1	0.005	40
TS-3 (Japan)	0.25	0.15 [1.5]	0.001	0–0.2	0.1	OH	No	0.1	0.5		5–70
HIT-II	0.3	0.2 [1.85]	0.035	0.5	0.2	OH	No				
HIST (Japan)	0.3	0.24 [2]	0.005	0.2	0.15	OH	No	0.03	0.5		10
CDX-U	0.34	0.22 [1.6]	0.05	0.2	0.2	0.3	Yes	0.1	0.5	0.001	5
TST-M (Japan)	0.35	0.25 [1.5]	0.01	0.3	0.1	OH	No		0.1		
ETE (Brazil)	0.3	0.2 [1.8]	0.02	0.6	0.4	OH	No	Construction			
TST-2 (Japan)	0.37	0.23 [1.5]	0.1	0.4	0.2	OH	No	Construction			
TS-4 (Japan)	0.5	0.4 [1.5]	0.01	0–0.4	0.4	OH	No	Construction			

Table C.2. (continued)

Experiment	R (m)	a (m) [κ]	Pulse length (s)	B_t (T) [B_p (T)]	I (MA)	P_{heat} (MW)	Divertor?	$T_i(0)$ (keV) [$T_e(0)$]	$\langle n \rangle$ 10^{20} m^{-3}	τ (s)	β (%)
Intermediate Spherical torus (ST)											
Pegasus	0.45	0.4 [3.7]	0.08	0.15	0.4	2	No	First plasma 1999			
Globus-M (Russia)	0.5	0.35 [1.6]	0.2	0.6	0.4	1	No	First plasma 1999			
MAST (UK)	0.75	0.55 [2.3]	5	0.5	2	5	Yes	Commissioning, first plasma 1999			
NSTX	0.86	0.68 [2]	5	0.3	1	11	Yes	First plasma 1999			
Intermediate Reversed-field pinch (RFP)											
MST	1.5	0.50	0.08	0.1	0.5	OH + (2 RF)	No	0.2 (0.8)	0.3	0.006	10
RFX (Italy)	2.0	0.46	0.25	0.4	1 (2)	OH	No	0.3	0.5	0.002	10
TPERX (Japan)	1.7	0.45	0.10	0.2	1	OH	No	Commissioning in 1999			
TPE-RX											
Self-ordered Field-reversed configuration (FRC)											
U. Washington											
Magnetic dipole											
LDX (MIT)	1	1	>10	[0.25]	0		Yes	Construction			

Notes: (1) For stellarators, a is average plasma radius $\langle a \rangle$. Plasma parameters are maximum achieved values, not simultaneous sets of parameters. (2) Numbers in parentheses are projected for Alcator C-Mod.

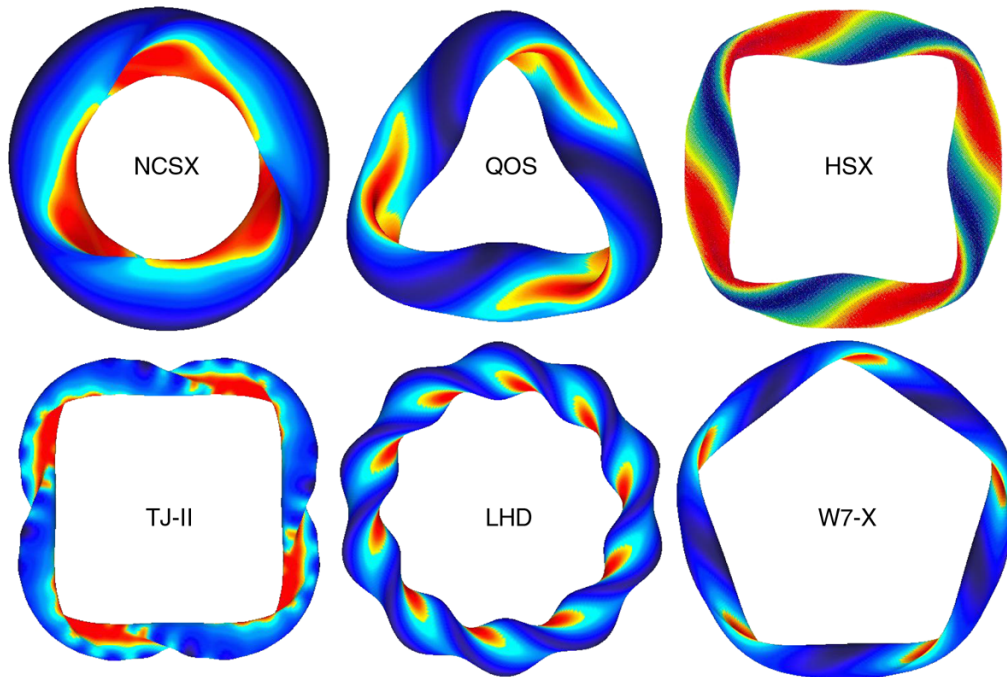
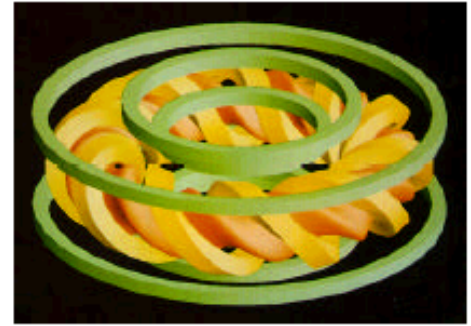

Fig. C.3. 3-D shaping of stellarator magnetic surfaces that provides flexibility to address a wide range of toroidal physics issues.

M-1. STELLARATOR

Description

Stellarators are toroidal confinement devices with helical magnetic field lines similar to those in a tokamak, but the confining poloidal magnetic field is created by currents in non-axisymmetric coils outside the plasma, rather than by a toroidal current within the plasma. The three-dimensional (3-D) plasma shaping in stellarators allows inherent steady-state operation with low recirculating power and avoids damaging disruptions. The flexibility of the externally generated poloidal field allows exploration of a wide range of magnetic configurations with different degrees of helical excursions of the toroidal magnetic axis, rotation and shear in the field lines, magnetic well depth, and plasma cross section shaping and aspect ratio, the essential building blocks of toroidal confinement systems. In the large stellarator program outside the United States, three lines of currentless stellarators with large-to-medium aspect ratios are being pursued. Stellarators are second only to the related tokamaks in investment, performance, and degree of physics understanding.



The LHD plasma and coil configuration.

Status

The technical basis for the design, fabrication, and projected performance of stellarators is well advanced. A confinement scaling (ISS95) based on data sets from all the world's stellarators also fits the tokamak L-mode database.

- **Experiments.** The main existing experiments are the \$1B-class superconducting-coil Large Helical Device (LHD) with $R = 3.9$ m, $\langle a \rangle = 0.65$ m, $B \leq 4$ T, and $P \leq 40$ MW in Japan; the Wendelstein 7-X (W7-X) with $R = 5.5$ m, $\langle a \rangle = 0.52$ m, $B = 3$ T, $P = 30$ MW under construction in Germany; the Japanese Compact Helical System (CHS) with $R = 1$ m, $\langle a \rangle = 0.2$ m, $B \leq 2$ T, and $P \leq 2$ MW; the German W7-AS with $R = 2$ m, $\langle a \rangle = 0.18$ m, $B \leq 2.5$ T, and $P \leq 3$ MW; and the smaller helical-axis stellarators (heliacs) in Australia (H-1), Spain (TJ-II), and Japan (Heliotron J).
- **Theory and computational tools.** The 3-D codes for calculations of magnetohydrodynamic (MHD) equilibrium and stability, magnetic configuration optimization, coil optimization, and divertor topology are well developed. The 3-D neoclassical transport, including the bootstrap current, energetic orbit confinement, and ambipolar electric fields, is well understood. Stellarators are now designed to meet a set of physics criteria by optimizing the shape of the plasma boundary, given the plasma pressure and current profiles, and a set of coils can then be generated to produce the desired boundary shape.
- **Engineering capabilities.** Computer-aided design and fabrication of complex vacuum vessels and coils is now routine as demonstrated by the successful fabrication of W7-AS, TJ-II, LHD, and the W7-X test coil. Manufacturing and assembly accuracies of <1 part in 1000 are routinely obtained. Large superconducting coils are in use on LHD and are under construction for W7-X.

Current Research and Development (R&D)

R&D Goals and Challenges

The key issues are (1) demonstrating reduced neoclassical transport, (2) further improvement in confinement over the ISS95 scaling, (3) understanding what limits the beta in a stellarator and obtaining $\langle \beta \rangle > 5\%$, (4) obtaining parameters (T_e , T_i , $\langle \beta \rangle$, τ_E) comparable to those in the mainline tokamak, and (5) developing practical particle and power handling techniques. The non-U.S. stellarator program is addressing these issues in large-aspect-ratio systems with very low bootstrap currents. Theoretical studies have recently identified promising concepts for “compact stellarators” that have relatively low aspect ratios and use bootstrap currents to advantage, but which are not currently being studied experimentally. A U.S. proof-of-principle (PoP) program is proposed to attack the stellarator R&D issues using these new configurations as a complementary part of the world stellarator program.

Related R&D Activities

Stellarators share many physics features with tokamaks, so many of the theory and modeling tools, plasma heating systems, and results from reactor studies are useful for both. The inherently 3-D nature of stellarators allows fundamental studies relevant to a variety of 3-D plasma applications: the magnetosphere, free electron lasers, accelerator transport lattices, and nonaxisymmetric perturbations to tokamaks and other toroidal confinement systems.

Recent Successes

- W7-AS: τ_E up to 2.5 times ISS95 scaling, demonstration of access to the electron root of the electric field ambipolarity condition, ion cyclotron range of frequency (ICRF) heating and plasma sustainment with no increase in density or impurities, and significant plasma parameters of $T_e = 5.7$ keV, $T_i = 1.5$ keV, $n_e = 3 \times 10^{20} \text{ m}^{-3}$, $\langle \beta \rangle = 1.8\%$, and $\tau_E = 55$ ms (not simultaneously).
- LHD: τ_E up to 0.17 s, 1.5 times ISS95 scaling, and quasi-steady-state operation up to 22 s with neutral beam injection (NBI) in initial experiments.
- CHS: $\langle \beta \rangle = 2.1\%$ and demonstrated large parallel viscous damping in a nonsymmetric configuration, radial electric field control, ICRF heating of the bulk plasma, and demonstration of enhanced pumping with a local magnetic island divertor.

Budget

The world stellarator program is funded at \$100M–200M/year. DOE–OFES funded activities (\approx \$0.8M/year) on conventional stellarators principally involve collaborations on LHD, CHS, and W7-AS.

Anticipated Contributions Relative to Metrics

Metrics

- The W7-X-based Helias Stellarator Reactor (HSR, with $R = 22\text{--}24$ m and $B = 5$ T) study indicates that a stellarator reactor can be built with present superconductors (NbTi) and present physics understanding. The key measures of necessary performance follow:
 - Neoclassical transport much less than ISS95 scaling and losses of energetic particles $\lesssim 5\%$.
 - Thermal plasma confinement better than two times ISS95 scaling.
 - Plasma parameters competitive with tokamaks ($T_i > 10$ keV, $\langle\beta\rangle > 5\%$, $\tau_E > 0.3$ s, and $n\tau_{ET} > 10^{20}$ keV·s·m⁻³).
 - Bootstrap current <10% of that in a comparable tokamak at high β and low collisionality.
 - True steady-state operation (~ 1 h) without current drive and without disruptions at $\langle\beta\rangle > 5\%$.
 - Superconducting coils with $B = 5$ T and fabrication and assembly accuracies <1 part in 1000.
 - Practical power and particle handling schemes that are extrapolatable to a reactor-relevant configuration.

Near Term ≤ 5 years

- LHD will extend stellarator plasma parameters to more relevant regimes ($T_i \sim 10$ keV, $\langle\beta\rangle \geq 5\%$, $\tau_E > 0.2$ s, $n\tau_{ET} > 10^{20}$ keV·s·m⁻³ with $P \sim 40$ MW) and study improved confinement modes, steady-state (30-min) operation with $P \sim 3$ MW, simulated alpha-particle confinement, and particle control with a local island divertor.
- W7-AS will operate through 2001 and test a W7-X-relevant magnetic island divertor, operate at full power for 3-s pulses, use particle control (with the divertor and pellet injection) to test the effect on H-mode and confinement improvement and verify the density scaling of confinement, and study control of the electric field with perpendicular neutral beam injection.
- Helical-axis stellarators in Spain, Australia, and Japan will test the advantages of higher rotational transform, larger helical axis excursions, and beam cross-sectional shaping of the plasma with multimegawatt plasma heating for a range of heliac configurations.
- Reactor studies in Germany and Japan will assess the reactor potential of the W7-X and LHD approaches.

Midterm ~ 20 years

- The superconducting-coil LHD will extend operation to $B = 4$ T and operate with a full helical divertor in Phase II of the LHD program starting in 2001.
- The superconducting modular coil stellarator W7-X will begin operation in 2005–2006 and demonstrate low neoclassical transport, low equilibrium and bootstrap currents, a practical magnetic-island-based divertor, and more reactor-relevant plasma parameters: $T > 10$ keV, $\langle\beta\rangle \geq 5\%$, and $n\tau_{ET} > 10^{20}$ keV·s·m⁻³.
- If results from the world stellarator programs meet expectations, a deuterium-tritium (D-T) stellarator in which a large part of the power is produced by fusion reactions would be constructed at the end of this period to study the key reactor issues of thermal confinement, energetic and alpha-particle losses, MHD stability and beta limits, and steady-state particle and power handling where a significant fraction of the heating power is from fusion-generated alpha particles.

Long Term > 20 years

Depending on results from D-T stellarator operation and the status of the world fusion program, a superconducting-coil stellarator in the demonstration reactor (DEMO) class would be constructed. If successful, this would open up an inherently steady-state disruption-free route to a fusion power plant with good confinement and beta and low recycled power.

Proponents' and Critics' Claims

Proponents claim that (1) stellarators can have good performance (confinement, beta) with no disruptions in true steady-state operation without the need for current drive or a potentially unstable bootstrap-current-dominated equilibrium; (2) decades of experience demonstrate that stellarators can be built with the desired accuracy; (3) the key issues for the viability of the stellarator approach will be addressed in the large superconducting-coil stellarators LHD and W7-X; (4) the wide range of stellarator configurations extends our scientific understanding of toroidal confinement; and (5) stellarators could lead to a reactor that is more reliable than an advanced tokamak reactor and would have low recycled power.

Critics claim that (1) conventional stellarators lead to very large reactors; (2) helical coils are risky because they cannot be tested before the whole device is completed; (3) nonplanar coils are difficult to manufacture, are costly, and lead to too high a ratio of field on the coils to that in the plasma; and (4) stellarators have not yet demonstrated the improved confinement regimes and the particle and power handling of tokamaks.

M-2. COMPACT STELLARATOR

Description

Compact stellarators, with one-half to one-third plasma aspect ratios of conventional stellarators, are nonaxisymmetric toroidal confinement devices that have helical magnetic field lines similar to those in tokamaks and conventional stellarators, but the confining poloidal magnetic field is created by both the plasma-generated internal “bootstrap” current and currents in external coils. This additional flexibility allows exploration of magnetic configurations that could combine the low aspect ratio and good performance of advanced tokamaks (ATs) with the disruption immunity and low recycled power of stellarators. Two new approaches are proposed: quasi-axisymmetry (QA), which uses the bootstrap current to produce about half of the confining poloidal field and has tokamaklike symmetry properties, and quasi-omnigeneity (QO), which approximately aligns bounce-averaged drift orbits with magnetic surfaces and aims at a smaller bootstrap current. The edge magnetic shear can be opposite to that of the AT, stabilizing neoclassical magnetic islands and permitting higher external kink stability limits without a nearby conducting wall. Complementing this is the quasi-helically symmetric (QH) approach, which produces configurations with high effective rotational transform, small deviations from a magnetic surface, and little bootstrap current. The main element of the proposed U.S. compact stellarator proof-of-principle (PoP) program is the QA National Compact Stellarator Experiment (NCSX).

Status

The technical basis for design, fabrication, and projected performance of compact stellarators is well advanced. The stellarator confinement scaling ISS95 also fits the tokamak L-mode data base. Experiments on low-beta high-aspect-ratio stellarators with plasma current showed that disruptions were suppressed when the fraction of the rotational transform generated externally exceeded 20%. Control (and even reversal) of the bootstrap current and its agreement with theory have been demonstrated.

- The Helically Symmetric Experiment (HSX, with $R = 1.2$ m, $\langle a \rangle = 0.15$ m, $B \leq 1.3$ T, and $P = 0.2$ MW) at the University of Wisconsin will begin operation in May 1999. It will be the world's first quasi-symmetric (QH) stellarator.
- The Compact Auburn Torsatron (CAT, with $R = 0.5$ m, and $\langle a \rangle = 0.1$ m) at Auburn University studies field errors, plasma flow, and ion cyclotron range of frequency (ICRF) heating. It is being upgraded to $B = 0.5$ T, $P = 0.2$ MW, and 25-kA ohmic current in order to study kink stability.
- Theory and computational tools. The shape of the last closed flux surface determines the magnetic configuration properties. It is used to design the coils that create optimized configurations. Three-dimensional (3-D) codes for calculations of magnetohydrodynamic (MHD) equilibrium and stability, configuration and coil optimization, and divertor geometry are well developed. Neoclassical transport, the bootstrap current, energetic orbit confinement, and ambipolar electric fields are well understood.
- Engineering capabilities. Computer-aided design and fabrication of accurate, complex vacuum vessels and coils are now routine.
- Concept design. The NCSX PoP facility is being designed based on a QA plasma configuration with an outer boundary shaped to satisfy physics goals: stability to ballooning and kink modes at $\langle \beta \rangle = 4\%$ without a conducting wall, $>50\%$ of the poloidal field from external coils, and profiles consistent with the bootstrap current. Scoping studies for a QO concept exploration experiment with higher rotational transform are focusing on optimizing energetic particle confinement and β .

Current Research and Development (R&D)

R&D Goals and Challenges

The key issues for compact stellarator configurations are (1) demonstrating improved neoclassical transport, (2) improving confinement over the ISS95 scaling, (3) understanding what determines the limiting beta and obtaining $\langle \beta \rangle \geq 5\%$, (4) demonstrating disruption-free operation at high beta, and (5) developing practical particle and power handling approaches.

Related R&D Activities

Compact stellarators combine stellarator and AT features in the same device and thus share many physics features with stellarators and tokamaks. Many of the physics results, theory and modeling tools, plasma heating systems, and reactor studies are useful to all three approaches. The U.S. compact stellarator program complements the large world stellarator program in which large-to-medium aspect ratio and low bootstrap current are emphasized. The inherently 3-D nature of compact stellarators allows fundamental studies relevant to a variety of 3-D plasma applications.

Recent Successes

- Configuration optimization codes now generate plasma configurations with specified physics properties such as drift surface alignment with magnetic surfaces, magnetic symmetry, plasma current profile, total current, rotational transform profile, magnetic well, plasma aspect ratio, magnetic field ripple, outer surface curvature, and ballooning and kink stability limits.
- Coil optimization codes now include desired engineering properties such as coil type (nonplanar, saddle, or helical); distance between the last closed flux surface and the coil winding surface; and degree of harmonic content in the coils.
- QA and QO configurations have been found that should be free of disruptions with good neoclassical confinement, attractive beta limits, and practical modular coils that can take advantage of existing toroidal facilities to minimize cost.

Budget

DOE–OFES: FY 1998 = \$5.9M; and FY 1999 = \$8.3M. The total PoP program budget [covering HSX, CAT, theory, international collaboration, and the proposed NCSX and quasi-omnigeneity symmetry (QOS) experiments] for FY 2000 is \$15.7M, increasing to \$30M/year in later years. The largest part (\$20M/year) of this is for the NCSX program. The proposed Compact Stellarator PoP program was reviewed favorably by a DOE review panel for PoP programs, and FESAC recommended funding to maintain the program momentum.

Anticipated Contributions Relative to Metrics

Metrics

- The 1994 Stellarator Power Plant Study indicated that a modular stellarator with $R = 14$ m and $B = 5$ T would be competitive with the second-stability Advanced Reactor Innovation and Evaluation Studies (ARIES)-IV tokamak reactor for the same costing and materials assumptions if $\langle\beta\rangle = 5\%$ and $\tau_E \geq 2$ times τ_E (ISS95). Compact stellarators offer the possibility of reducing R by a factor ~ 2 and higher (more economical) wall loading. Measures of the required performance follow:
 - Neoclassical transport much less than ISS95 scaling and losses of energetic particles $\lesssim 10\%$.
 - Thermal plasma confinement better than two times the ISS95 scaling.
 - Plasma parameters competitive with tokamaks ($T_i > 10$ keV, $\langle\beta\rangle > 5\%$, $\tau_E > 0.3$ s, and $n\tau_E T > 10^{20}$ keV·s·m⁻³).
 - Compatibility of the bootstrap current (and its control) with operation at high β and low collisionality.
 - Immunity to disruptions with a large bootstrap current contribution to the rotational transform in true steady-state operation.
 - Superconducting coils with $B = 5$ T and fabrication and assembly accuracies < 1 part in 1000.
 - Practical steady-state power and particle handling schemes that can be extrapolated to a reactor-relevant configuration.
 - Reactor designs with good plasma-coil spacing ($\Delta(R/\Delta < 4)$) and coil utilization ($B_{\max}/B_0 < 3$).

Near Term ≤ 5 years

- A coordinated U.S. PoP program is proposed to attack key issues in combination with the world program.
- Two complementary compact stellarators will be built and start operation in 2003–2005: NCSX, a QA PoP experiment, and QOS, a concept-exploration-level experiment—the new elements in the U.S. compact stellarator PoP program.
- HSX will explore the QH approach with coils that allow the degree of symmetry, neoclassical transport, magnetic well depth, stability, rotational transform, and parallel viscosity to be varied. HSX will (1) demonstrate the reduction in particle drifts from flux surface due to large effective rotational transform; (2) test reduction of neoclassical electron thermal conductivity and direct orbit losses; (3) demonstrate whether reduction of parallel viscosity in symmetry direction decreases the momentum damping rate; and (4) explore whether large $E \times B$ shear can be obtained due to quasi-symmetry or the ambipolarity constraint.
- CAT-upgrade will investigate the disruptivity of current-carrying helical plasmas over a wide range of rotational transform profiles and test different ICRF heating scenarios for application to other stellarators.
- Scoping and ARIES studies will assess the reactor potential of compact stellarators and help define the critical issues.
- The Large Helical Device (LHD) will study improved confinement modes, steady-state operation, and particle control with a local island divertor.
- The German Wendelstein 7-AS (W7-AS) will test a compact-stellarator-relevant island divertor, study H-mode and confinement improvement, study operation with a net plasma current and control of the electric field with perpendicular neutral beam injection.

Midterm ~ 20 years

- The NCSX PoP facility ($R = 1.5$ m, $\langle a \rangle = 0.45$ m, $B = 1\text{--}2$ T, and $P = 6\text{--}12$ MW) will explore the QA optimization approach and address key compact stellarator issues: (1) operation at high β with bootstrap currents and external transform without disruptions; (2) understanding of β limits and the limiting mechanisms; (3) reduction of neoclassical transport to a low level by proper configuration design; (4) control of turbulent transport (e.g., by flow shear), leading to enhanced global confinement; and (5) suppression of neoclassical islands and tearing modes by bootstrap current and stellarator magnetic shear.
- The QOS concept-exploration device ($R \leq 1$ m, $\langle a \rangle < 0.28$ m, $B = 1\text{--}2$ T, and $P \leq 4$ MW) would test reduction of (1) neoclassical transport via nonsymmetric QO and the effect of electric fields on confinement; (2) energetic orbit losses in nonsymmetric low-aspect-ratio stellarators; (3) the bootstrap current, its control, and the configuration dependence on β ; and (4) anomalous transport by methods such as sheared $E \times B$ flow, and understand flow damping in nonsymmetric configurations.
- W7-X will extend our understanding of reduction of neoclassical and anomalous transport, reduction of equilibrium and bootstrap currents, scaling of beta limits, and optimization of island-based divertors for steady-state particle and power handling.

Long Term > 20 years

- If results from the total U.S. stellarator PoP, LHD, and W7-X programs meet expectations, a proof-of-performance superconducting-coil and/or D-T Compact Stellarator could be used to study key issues of confinement, MHD stability, particle and power handling, and possibly D-T physics at $T > 10$ keV, $\langle\beta\rangle > 5\%$, and $n\tau_E T > 10^{20}$ keV·s·m⁻³ with $P > 30$ MW and $B > 3$ T.
- If results from the above experiments prove favorable, then the next step would be a Compact Stellarator Experimental Test Reactor.

Proponents' and Critics' Claims

Proponents claim that compact stellarators could combine the low aspect ratio and good performance of tokamaks (confinement, beta) with the disruption immunity and low recycled power of stellarators. Compact stellarator configurations, stellarator-tokamak hybrids, that use the bootstrap current and quasi-symmetry or QO, would extend our scientific understanding of toroidal confinement and could lead to a reactor that is economically competitive with, but more reliable than, the AT.

Critics claim that (1) nonplanar stellarator coils are difficult to manufacture, are costly, and lead to a higher ratio of field on the coils to that in the plasma, so the beta limit needs to be higher to be more attractive than in tokamaks; and (2) stellarators have not yet demonstrated the improved confinement regimes and the particle and power handling of tokamaks.

M-3. TOKAMAK

Description

The tokamak is an axisymmetric toroidal magnetic configuration that combines a strong toroidal magnetic field with toroidal plasma current to produce a helical field, having a safety factor >1 at the edge of the plasma. Within this definition, there is considerable freedom in further specifying the configuration, its properties, and ultimately, its potential as a fusion power system. Because of its demonstrated superiority in confining plasmas at high pressure and temperature, the tokamak has played the dominant role in the remarkable progress over the last three decades in the quest to understand and harness fusion energy.

Status

Recent progress in worldwide tokamak fusion research includes groundbreaking physics experiments with deuterium-tritium (D-T) plasmas, which have produced substantial fusion power, to study confinement of energetic fusion alpha particles and energy transfer from them to the thermal plasma; developing fundamental understanding and demonstrating the suppression of turbulence-driven energy transport; producing plasmas with significant self-generated bootstrap plasma currents, a key step on the route to energy efficient steady-state operation; and demonstrating practical methods to disperse plasma power exhaust and control particle exhaust, a synergy between plasma and atomic physics. These advances have validated tokamak power plant concepts, generated a new research strategy (the advanced tokamak program), stimulated further innovation, and broadened the fusion science base.

The tokamak is ready to progress to the next crucial step in the development of fusion, the study of the nuclear self-heating regime ($Q > 10$). Tokamaks capable of achieving this goal have been designed and proposed. They span a range of sizes and magnetic fields, from the compact high-field copper coil of the Compact Ignition Tokamak (CIT), Ignitor, and Burning Plasma Experimental Reactor (BPX) class, up to the full-size International Thermonuclear Experimental Reactor (ITER) as embodied in the engineering design activity (EDA), which seeks to combine the goal of studying ignited plasmas with a comprehensive technology development mission. Recent international activity is focusing on a reduced-scale (and cost) superconducting reactor, which might incorporate some of the advanced features being developed in the research and development (R&D) programs; domestically, refinements of the high-field burning plasma tokamak options are being pursued.

Power plant system studies show the possibility of a tokamak power plant with competitive cost of electricity, steady-state operation, maintainability, low-level waste, and public and worker safety. Examples include the American Advanced Reactor Innovation and Evaluation Studies (ARIES)-RS and Japanese SSTR studies.

Current Research and Development

Crucial tokamak issues are pursued in a vigorous, worldwide tokamak program of experiments, fundamental theory, and theory-based simulations. Cross-field plasma transport in toroidal devices has been dominated by the almost universal presence of turbulence; indeed, the electromagnetic interaction has made the plasma medium ideal for studies of turbulence, allowing detailed diagnosis and even control. The discovery of high confinement operating regimes in the tokamak has revolutionized expectations for plasma performance. Transport barriers (influenced by magnetic shear and momentum input), regions of reduced low turbulence, and therefore slow diffusion, have been discovered, with H-Mode edge and pellet-enhanced performance (PEP) mode and supershot core barriers being long-standing examples. A unifying interpretation, based on the paradigm that sheared plasma flow decorrelates and stabilizes the important turbulent modes, has shown a remarkable and robust ability to explain the observations. Many aspects of tokamak transport physics are generic to all magnetic confinement; tokamaks have the simplicity of configuration, long pulse length, low collisionality plasmas, and the detailed diagnostics needed to study them and obtain improved confinement for fusion.

Maximizing the fusion power density by increasing the plasma pressure is crucial for a reactor. A major program is devoted to understanding beta limits and increasing plasma stability, through current, pressure, and rotation profile control. Many aspects of tokamak magnetohydrodynamic (MHD) stability are well understood theoretically, and a good capability to predict global limits in standard confinement regimes has been developed. A critical area of intensive research is that of the sudden disruption of plasma current due to MHD instabilities. There are engineering consequences of disruptions for the design of burning plasma tokamak experiments and ultimately power plants. Experiments on mitigation and avoidance, coupled with the development of a fundamental understanding of the physics mechanisms, have significant priority. The important effects of nonideal MHD behavior on stability is another area of active research.

To minimize recirculating power in a reactor, maximum use must be made of the bootstrap-driven current, a major thrust of the advanced tokamak program. To increase stability, localized plasma current can be driven by ion cyclotron range of frequencies (ICRF), lower hybrid, electron cyclotron, and mode conversion techniques. Wave-plasma interactions may also prove to be key in controlling transport in a burning plasma. The radio frequency (rf) approaches have been proposed to control plasma rotation and thus transport barrier evolution.

The temperature and density just inside the edge transport barrier are governed by plasma stability and transport and have a profound influence over core confinement and therefore over accessibility of self-heating and ignition. Determining the dependence of these pedestal characteristics on other plasma parameters will allow more reliable understanding of fusion ignition requirements, more detailed comparisons to stability predictions and better general understanding of high-confinement physics. In most current tokamaks, heat and particle outflux are handled with a poloidal divertor configuration, in which the plasma edge is diverted magnetically into a chamber for helium ash removal and control of plasma-wall interactions by atomic processes. Divertor experiments need to establish a practical and preferably fundamental basis for predicting cross-field energy and particle transport in the scrape-off layer.

Budget

For FY 1999, the Office of Fusion Energy Sciences (OFES) support in the tokamak science area, including international collaborations and Small Business Innovation Research (SBIR)/STTR grants, is \$49.1M; in addition, \$38.9M supports major facility operations.

Anticipated Contributions Relative to Metrics

Metrics

Parameters	$n\tau$	$n\tau T$	<pressure>	Q	Pulse length	P_{fusion}	$P_{\text{in}}/S_{\text{plasma}}$
Achieved	$1.4 \times 10^{20} \text{ s/m}^3$	$1.5 \times 10^{21} \text{ s-keV/m}^3$	$1.6 \times 10^5 \text{ Pa}$	~1	10^2 s	$2 \times 10^7 \text{ W}$	0.5 MW/m^2
Reactor	$2 \times 10^{20} \text{ s/m}^3$	$2 \times 10^{21} \text{ s-keV/m}^3$	$5 \times 10^5 \text{ Pa}$	>20	$>10^4 \text{ s}$	10^9 W	~1 MW/m ²

Note: not all parameters achieved simultaneously.

Near Term ~5 years

The world program is technically ready to move to the next step in fusion development, the construction of a tokamak to produce and study burning plasma with dominant nuclear self-heating. This step can start within the next 5 years. Europe, Japan, and the Russian Federation are continuing the ITER EDA, now focused on a reduced-cost, reduced technical objectives version of ITER. When and if a firm commitment is made by the ITER parties for construction and a site is selected, the United States could request the opportunity to rejoin as a research partner. If, on the other hand, ITER does not go forward, other approaches to addressing burning plasma physics issues, most likely on an international basis, could be pursued. In parallel, the tokamak program is moving aggressively to develop solutions to the challenges that must be met for subsequent steps, including disruption control, long-pulse/steady-state operation, current, particle and momentum profile control, active control of MHD instabilities, and advanced divertor dissipation of ultra-high heat flux.

Midterm ~20 years

The construction of ITER would occur over the next 10 years, and its operation period could be 10 to 20 years. If ITER is not constructed, then burning plasma science could be studied on a next-generation tokamak, and an advanced integrated experimental reactor could be designed and construction begun by about 2015. Assuming continued success of the tokamak, which is likely with advanced control features and enhanced performance, this device will incorporate reactor prototypical features (superconducting magnets, including the possibility of high-field/high-temperature technology, steady-state operation), which will be close to a demonstration reactor. Even if some alternate to the tokamak is chosen for this device, the knowledge gained from the burning plasma tokamak experiment is a required prerequisite for moving forward in the development of magnetic fusion energy on this time scale.

Long Term >20 years

We can anticipate that the operation of the Advanced Integrated Experimental Reactor could commence as early as 2025, to be followed by the demonstration of a commercial reactor prototype by the middle of the century.

Proponents' and Critics' Claims

Proponents think that the world MFE program is ready to move forward to a burning plasma experiment; the tokamak is the vehicle with which to do so. Compared to its nearest fusion competitor (the stellarator), the tokamak has demonstrated 100 times larger nT_e , 30 times higher plasma pressure, >40 times higher first-wall neutron load, and >10 times higher duty cycle. With advanced confinement, current drive and MHD features, the tokamak has the promise to be an economically viable, environmentally attractive fusion power producer.

Critics note that major disruptions are unacceptable for a power plant. Low recirculating power solutions must be demonstrated for steady-state current maintenance.

M-4. ADVANCED TOKAMAK

Description

Advanced tokamak (AT) research seeks to determine the ultimate potential of the tokamak as a magnetic confinement system by pursuing innovation and optimization and by raising the upper limits to performance. The technical gains have the potential to reduce the cost of fusion development steps and power plants. The physics base built using the tokamak is sufficiently well developed to define theoretically the expected ultimate potential of the tokamak.

- **Stability.** Theory experiments have established a beta limit given by $\beta_N (= \beta_T/(I/aB)) \sim 3$ for free boundary equilibria with standard tokamak profiles and no wall stabilization. With optimized current and pressure profiles and assuming wall stabilization of low-order kink modes, stability calculations show a capability of $\beta_N < 6$ in the conventional aspect ratio range.
- **Confinement.** The theoretical minimum in cross-field transport is the rate set by charged particle collisions, neoclassical transport. Turbulence in the plasma raises the transport above the neoclassical level. It now appears possible to attain the theoretical minimum transport level in the ion transport by suppression of turbulence by sheared $E \times B$ flows in the plasma.
- **Steady state.** The theoretically predicted and experimentally confirmed bootstrap effect is the basis for steady-state operation of a tokamak. In principle, all the plasma current can be self-generated by the bootstrap effect. Methods of noninductive current drive are well developed. With research on noninductive startup, the AT thrust seeks to define fully transformerless operation.
- **Power and particle control.** The high beta states sought in the AT thrust lead to high power density systems that call for advanced methods to exhaust power, fuel, and ash without impairing the advanced core plasma performance. The leading candidate approach is the divertor in which the edge plasma is guided into a separate (divertor) chamber for power and particle exhaust.

Status

The advanced state of scientific maturity of plasma measurements and available theory for comparison on tokamaks has enabled the AT thrust. Current effort is on improved plasma control methods and hardware.

- **Stability.** Target stability levels have been produced transiently. Wall stabilization has a physics basis in the reversed-field-pinch (RFP) and spheromak; preliminary investigations in the tokamak have begun.
- **Confinement.** The discovery and physics principle of turbulence suppression by sheared $E \times B$ flow (generating a transport barrier) has been shown to be active in a variety of magnetic confinement devices: tokamaks, stellarators, mirrors, and perhaps even the RFP. Plasmas have been made with a transport barrier across most of the discharge, resulting in neoclassical ion transport rates and almost no detected turbulence in the ion gyroradius wavelength range across the plasma. Transport barriers in the electron channel have been seen, but reductions in transport have been less than for the ions. Improved confinement, gauged by a multiplier over nominal confinement, has been produced transiently.
- **Steady state.** Current and pressure profiles consistent with such operation and stability and transport barriers have been calculated. Methods of noninductive current drive are well developed. Bootstrap fractions up to 80% have been measured.
- **Power and particle control.** From experimental work and modeling, it appears possible to push toward states in which the plasma nearly completely recombines before the hot plasma can touch the material wall.

Current Research and Development (R&D)

R&D Goals and Challenges

- **Stability.** Two paths appear possible to realize the optimized current and pressure profiles and wall stabilization. Current profiles that have a magnetic shear reversal [negative central shear (NCS)] put a current peak closer to the wall for wall stabilization. The high internal inductance (I_i) path seeks to move the current as far away from the edge as possible to allow operation at perhaps $\beta_N \sim 4$ without wall stabilization. Wall stabilization is sought by maintaining plasma rotation and by feedback control of low-order kink modes. Neoclassical tearing modes must be dealt with in positive shear regions.
- **Confinement.** R&D seeks to expand the radius of transport barriers to raise the overall confinement and to sustain them in steady state. Progress in the electron transport channel is sought.
- **Steady state.** Off-axis current drive is needed for the NCS scenario. Sawtooth stabilization or axial safety factor control is needed for the high I_i scenario.
- **Power and particle control.** Further work is needed on recombining plasmas, the use of impurity ions on plasma edge to radiate power, and the use of the parallel flow of impurities to store ions in the divertor region and radiate power.

Related R&D Activities

AT issues are being pursued in all the major tokamaks in the world. Worldwide, the DIII-D tokamak pioneered and defined the AT research thrust. DIII-D is seeking to develop the reversed shear (RS) scenario at high beta and at low magnetic field using 110-GHz electron cyclotron current drive and a divertor for highly triangular plasmas. The Alcator C-mod tokamak, which operates at high magnetic field and density, is pursuing AT scenarios using lower hybrid wave current drive. The required AT performance levels have been attained transiently (see Fig. 1) and need to be extended to steady state.

Recent Successes

Recent advances in the AT performance gauge, the product of β_N and the H-factor, from the DIII-D tokamak are shown in Fig. 1. The JT-60U tokamak has reported the world record QDT equivalent = 1.25 using an AT mode.

Budget

See M-3.

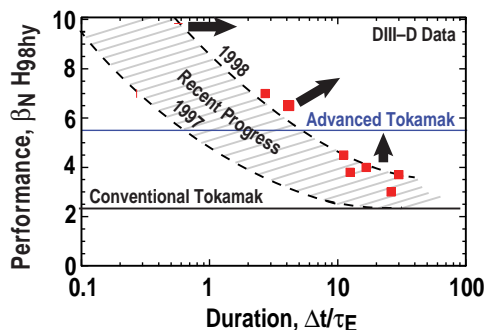

Fig. 1. Tokamak performance levels.

Anticipated Contributions Relative to Metrics

Metrics

Metrics have been quantitatively and qualitatively derived from predictive theory. Overall, the main metric will be the degree to which theoretical expectations can be achieved. The stability targets are calculated by accurate codes; a numerical target is to push β_N up toward 6, which requires wall stabilization. Attainment of ion transport near, at, or even below the neoclassical minimum has been shown in many tokamaks. Transport barriers in the electron channel have been seen, but it is probably not possible to reduce electron transport to its very small neoclassical minimum. A reasonable metric would be electron transport rates as low as ion neoclassical, which will suffice for future tokamak power systems. Achieving full self-generated current is the correct goal for steady state; but for control purposes, it will probably be desirable to drive some of the plasma current with external systems. Power and particle control progress can be gaged by the fraction of recombination and the fraction of radiated power that can be produced in the plasma mantle and divertor.

Near Term ≤ 5 years

In 5 years, it should be possible to sufficiently flesh out the ultimate potential of the tokamak to enable future tokamak designs to be based on AT approaches. The two tokamaks in the United States, DIII-D and Alcator C-mod, will carry out the bulk of this research if they are able to complete their necessary plasma control upgrades [ECCD and divertor on DIII-D, lower hybrid current drive (LHCD) and core diagnostics on Alcator C-mod]. Programs are in place to implement the required current profile control and divertor systems. A feedback system for wall stabilization is being implemented on DIII-D. While great progress is being made in transport barrier physics, transport barrier control methods are only just emerging. The JT-60U tokamak is working to extend AT modes to very long duration. The Joint European Torus (JET) tokamak expects to produce a record fusion power output using the “optimized shear” mode in its next D-T campaign.

Midterm ~ 20 years

A number of future devices that can take advantage of the AT physics can be demonstrated in the near term. The superconducting tokamaks KSTAR in Korea and HT-7U in China will take AT physics into very long pulse demonstrations. The JT-60SU superconducting tokamak in Japan predicated its D-T phase on AT operating modes. The reduced-cost (RC) ITER design has moved to the kinds of plasma shapes optimal for AT performance. RC-ITER will be a good development facility for the AT approach and may recover full ITER performance levels through AT operation. Compact, pulsed ignition experiments might be able to achieve high thermonuclear performance at lower machine parameters (7 MA and 7 T instead of 11 MA and 11 T) and for longer pulse lengths. We also note that the basic AT physics approaches (high β_N through hollow current profiles and wall stabilization, transport barriers through radial E-fields, high bootstrap fractions, and radiative mantles) are important elements of the spherical torus approach. The wall stabilization techniques developed in the AT program will be necessary in future long pulse spheromaks, and RFP and possibly in the field-reversed configuration (FRC). Suppression of turbulence by sheared ExB flow can be expected to appear in any device dominated by electrostatic turbulence.

Long Term >20 years

From the AT work done to date, the physics potential of the tokamak appears to exceed what is necessary to define a minimum-sized power plant based on technology limitations alone (stress levels on magnets, neutron fluxes at the blanket). For the superconducting tokamak, the minimum size is set by inboard radial build constraints to be over 5-m major radius. Using elements of AT physics at low aspect ratio, spherical tokamak (ST) pilot plants in the 1.5-m major radius range and power plants in the 3- to 4-m major radius range might be possible.

Proponents' and Critics' Claims

Proponents stress that “What is the ultimate potential of the tokamak configuration?” is the kind of basic scientific question the fusion science program should address (and for all configurations to be brought forward). Critics cite the uncertainty in achieving the AT objectives and the undesirability of delays in committing to construction of new devices while waiting for AT results. Proponents argue that higher performance and less costly devices may be built once the ultimate potential of the tokamak is known.

M-5. ELECTRIC TOKAMAK

Description

The electric tokamak (ET) differs from the advanced tokamak (AT) because it proposes to use the electric shear-flow stability not for improving confinement but for reaching deep second stability as its principal regime of operation. The goal is to approach unity beta in the plasma core at a high aspect ratio ($A \sim 5$). Strong radio frequency (rf) driven fast ion loss will be used for stability control. Because of the resulting rapid poloidal rotation, the usual thermal ion bananas do not have a chance to develop. In fact, the thermal ion drift surfaces become “omnigenous” for the ions, that is, locked to the magnetic surfaces. This is referred to as “electric omnigenity,” which is in effect when $V_{\text{poloidal}} > \epsilon v_{ti}$. The resulting orbit level ion control should result in a low level of turbulence and in “classical”—not just neoclassical—ion confinement. Present-day tokamaks can only achieve neoclassical ion confinement. In addition to removing the ion bananas electrically, researchers will try to remove the electron bananas through developing magnetic omnigenity in a deep magnetic well, where the mod-B surfaces tend to align themselves with the magnetic surfaces. In this high-pressure limit, expectations are that CLASSICAL electron thermal confinement can be approached as well. ET is now producing discharge cleaning type plasmas and 100-kA reversed-field-pinch (RFP) currents at only 70-gauss toroidal fields. Tokamak operation is expected to start in the summer of 1999. The initial physics research needed will be conducted in an $R = 5$ m, $a = 1$ m, $b = 1.5$ m torus at 0.25-T magnetic fields. If the physics exploration phase bears fruit the next 2 years, then a proof-of-principle experiment could be conducted in the same device, at 1 T, with minor upgrades. At 1-T fields, ignition-grade hydrogen plasma could be confined with the required Lawson parameters. This strictly requires near unity beta and near classical ion confinement. The electron channel can still remain below neoclassical.

Status

- The chamber is completed, and toroidal field coils will be completed by May 1999 at University of California–Los Angeles (UCLA).
- Conventional tokamak operation is scheduled to begin in the summer of 1999.

Current Research & Development (R&D)

R&D Goals and Challenges

Ion cyclotron range of frequency (ICRF) control for current drive, heat, and rotation control involves the development of codes and hardware. The code development is approached through a connection to numeric tokamak programs in the United States. The challenge will be to provide high-grade rf heating to the ET plasma.

Related R&D Activities

A low-cost chamber, magnet, and rf system development has been undertaken, so university-size resources can be used for fabrication of an International Thermonuclear Experimental Reactor (ITER) sized tokamak at low magnetic fields.

Recent Successes

Fabrication and checkout of the chamber and magnet systems has been more successful than anticipated. This can be attributed to the wide use of in situ chamber fabrication using computer-guided plasma torches and to the low magnetic field stress environment of this high-beta tokamak. The rf input is tested in one port, and 100-kA type RFPs have been produced for low-cost pulsed discharge cleaning.

Budget

\$1.5 M/year or more is needed for the physics test.

Anticipated Contributions Relative to Metrics

Metrics

- High beta stability and control code development using low-cost parallel computing.
- Removal of the density limit in the tokamak using ET's high field heat input (MARFE control).
- Electron physics understanding using omnigenous magnetic surfaces (this is the only option).
- Development of techniques for reducing the cost of the tokamak reactor.

Near Term ≤ 5 years

Demonstration of reaching classical confinement and unity beta in a large torus with a minimum of 1-s energy confinement at $T(0) = 5$ kV, $n(0) = 5 \times 10^{13}/\text{cm}^3$.

Midterm ~ 20 years

Ignition and burn could be demonstrated using long pulses in an ITER-like chamber at near unity beta and at 2-T magnetic fields, using low-cost magnets. This requires a new facility with deuterium-tritium.

Long Term >20 years

With higher cost magnets, operated at 5 T, advanced fuels could be burned, if near unity beta and near classical confinement could be maintained. This would reduce "nuclear" costs.

Proponents' and Critics' Claims

Proponents note that classical confinement for ions and near unity beta in the core can be reached through active plasma control, requiring rapid poloidal rotation of the ions. Present-day tokamaks tend to be limited to slow poloidal rotation. Then we will be able to study the stability properties of magnetic wells at high aspect ratio.

Critics claim that there is not solid theoretical evidence that strong poloidal rotation will stabilize ideal MHD modes at near-unity beta. Critics also say that the power requirements for the proposed level of plasma rotation may result in a very high (likely greater than unity) power recirculation fraction in a reactor. But here the critics refer to their own reactor that they know so well.

M-6. SPHERICAL TORUS

Description

- The aspect ratio ($A = R_0/a$) of the spherical torus (ST) plasma approaches unity (1.1–1.6 typically) compared to $A = 2.5$ –5.0 so far for the tokamak and advanced tokamak (AT). As a result, the ST uses a modest applied toroidal field (TF) and has large I_p/aB and I_p/I_{tfc} values.
- Its magnetic surfaces combine a short field line of bad curvature and high pitch angle (relative to the horizontal plane) toward the outboard plasma edge with a long field line of good curvature and low pitch angle toward the inboard plasma edge. The dominance of good field line curvature leads to magnetohydrodynamic (MHD) stability at high plasma pressure, giving the potential for order-unity average toroidal and central plasma betas ($\beta = 2\mu_0 p/B^2$). High beta and the magnetic configuration combine to widen the parameter domain for magnetic fusion plasmas, the investigation of which will strengthen the scientific basis for attractive magnetic fusion energy (MFE) and other applications.
- The wider domain promises high-performance fusion plasmas possessing large trapped particle fraction (up to 90% near edge), Pfirsch-Schlüter current ($\sim I_p$), and toward the outboard, a magnetic well ($\sim 30\%$) with nearly omnigenous particle trajectories, dielectric constant ($\sim \omega_{pe}^2/\omega_{ce}^2 \gg 1$), normalized gyroradius ($\rho^* = \rho/a \sim 0.03$ –0.01), supra-Alfvén fast ions ($v_{fast} > v_A$), gradient-driven flow shearing rate ($\sim 10^6 \text{ s}^{-1}$), magnetic mirror ratio (~ 4), and flux tube expansion (≥ 10) in the naturally diverted (ND) outboard scrape-off layer (SOL) of inboard limited plasmas.
- The ST configuration also requires certain features in engineering and technology to maximize the potential ST benefits. These include single-turn demountable, normal-conducting toroidal field coil (TFC) center leg and vertical replacement and assembly of fusion core components in toroidally symmetric sections, anticipated to simplify remote maintenance.

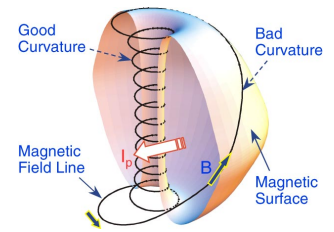

ST plasma magnetic configuration with $A \sim 1.25$, elongation $\kappa = 2$, and edge safety factor $q = 12$.

Status

- The small concept exploration experiments ($R_0 \leq 35$ cm), Small Tight Aspect Ratio Tokamak (START) in the United Kingdom, the Helicity Injected Tokamak (HIT) at the University of Washington, and the Current Drive Experiment-Upgrade (CDX-U) at Princeton Plasma Physics Laboratory (PPPL) have recently produced very encouraging results. These include average toroidal betas up to 40%, central local betas $\sim 100\%$, H-mode confinement, a large range in operating density ($\leq 2 \times 10^{20} \text{ m}^{-3}$) and q (1–30), a small and nearly symmetric halo current ($\sim 5\%$ of I_p) during plasma disruptions, and helicity injection startup of I_p (up to 200 kA).
- New or upgraded ST experiments include the National Spherical Torus Experiment (NSTX) at PPPL with $R_0 \sim 0.8$ m, $I_p \sim 1$ –2 MA; and smaller experiments Pegasus (University of Wisconsin), HIT-II (University of Washington), CDX-U (PPPL), to explore ST physics boundaries in extreme low A , noninductive startup, and radio frequency (rf).
- NSTX is a national proof-of-principle (PoP) research facility at PPPL. Construction is expected to be completed in April 1999.

Current Research and Development (R&D)

R&D Goals and Challenges

- The NSTX R&D goals are to investigate noninductive startup and maintenance of plasma current to eliminate the central induction solenoid; efficient plasma heating and current drive; turbulence suppression to improve confinement; stability at high toroidal average beta (up to 45%) with large well-aligned pressure-gradient-driven (thermoelectric) current (up to 80–90% of I_p); and dispersion of plasma exhausts over large wall and tile areas.
- The NSTX with other ST experiments aim to establish a database in 4–5 years for a performance extension ST device, which in turn aims to produce a database for an energy development ST device (see Metrics).

Related R&D Activities

- Foreign ST experiments, such as the Mega-Amp Spherical Tokamak (MAST) in the United Kingdom; Globus-M (Russian Federation); TS-3&4, TST-M, and HIST (Japan); and ETE (Brazil) are complementary to the domestic ST experiments in goals and capabilities (e.g., MAST has poloidal field coils inside a large chamber and no stabilizing shell near the plasma).
- Advanced computational simulation is needed to account for the strongly toroidal ST geometry and physics features.
- Enabling technologies are of particular importance to ST due to the anticipated high power densities in its small size.
- Power plant conceptual studies identify innovative approaches for near-term R&D to maximize the ST advantage.

Recent Successes

- ST experimental results are very encouraging; several new ST experiments are approaching completion (see Status).
- Under recent Small Business Innovation Research (SBIR) funding, feasible design concepts were developed for ST-based volumetric neutron source (VNS) and ST-driven transmutation power plants to burn fission actinides, requiring only ST plasmas of modest- Q in the first-stability regime.
- Feasible ST reactor plasma operation scenarios, assuming the advanced physics regime, and simplified maintenance concepts were developed by the Advanced Reactor Innovation and Evaluation Studies (ARIES) group, the United States, and the United Kingdom Atomic Energy Authority (UKAEA) Culham Fusion, United Kingdom.

Budget

For NSTX in FY 1999, PPPL receives \$5.5M to complete the project, \$3.5M to prepare neutral beam injection (NBI), \$0.9M for a laser scattering system, and \$7.9M to operate the national facility; scientists from PPPL and 13 collaborating institutions receive \$5.4M and \$2.8M, respectively, to begin research. Collaborators' research funding for FY 2000 will hopefully grow toward \$5M.

Anticipated Contributions Relative to Metrics

Metrics

R&D targets and opportunities estimated for the ST-based VNS ($R_0 \sim 1.1$ m) and power plant ($R_0 \sim 3$ m):

Energy metrics	VNS	Power	Physics metrics	VNS	Power
TF center leg material	DS-Cu ^a	DS-Cu ^a	Full noninductive I_p ramp up	Yes	Yes
Q-engineering	~ 0	$\sim 4-6$	Thermoelectric current fraction	~ 0.5	~ 0.9
Accessibility	Ample ^b	Ample ^b	Maximum β limit (%) / required β (%)	50/25	75/60
Maintenance approach	Eased ^c	Eased ^c	Required H_f (ITER98-H)	~ 1	~ 2
Environment and safety	<i>d</i>	<i>d</i>	Plasma power/wall area (MW/m ²)	~ 1	~ 1.6
Development path			Power and particle handling	ND	DN ^h
Modularity	<i>e</i>	<i>e</i>	Plasma/applied magnetic energy	~ 0.1	~ 0.1
Commonality of physics	<i>f</i>	<i>f</i>	B at R_0 /B at TF coil	~ 0.25	~ 0.25
Unit capital cost (\$B)	~ 1	~ 3	Uncontrolled shutdown frequency	$\rightarrow 0$	$\rightarrow 0$
Cost of electricity (mills/kW-h)		~ 70	Neutron wall loading (MW/m ²)	~ 1	~ 5
Near-term nonelectric applications	<i>g</i>				

^aDispersion-strengthened copper, which is estimated to be adequate for the VNS and could be improved for the reactor.

^bThe modest TF permits ample space between the TF return legs for access to the fusion plasma and core.

^cDemountable center leg for the TF coil and compact fusion core enable vertical access to axisymmetric core components.

^dEnvironment and safety issues, such as due to the juxtaposition of actively cooled normal, current-carrying conductors and high-performance power handling and conversion components, need to be investigated and resolved in the ST VNS.

^eST offers a modular low-cost path beyond NSTX: the deuterium-tritium spherical torus (DTST) for performance extension ($R_0 \sim 1.1$ m), VNS for energy development ($R_0 \sim 1.1$ m, $Q_{eng} = 0$), pilot plant ($R_0 \sim 1.4$ m, $Q_{eng} \sim 1$), and power demonstration plant ($R_0 \sim 3$ m, $Q_{eng} \sim 4-6$).

^fThe electron cyclotron wave effects on the ST plasma outboard resemble rf wave experimentation of the earth ionosphere.

^gSuccess of ST VNS could enable viable nearer-term nonelectricity applications such as source for neutron science, transmutation of nuclear waste, and production of tritium and isotopes for fusion, industrial, and medical uses. The fusion physics and technology metrics for such applications are significantly less than those required for fusion power.

^hDouble-null (DN) divertors may be needed to ensure advanced physics regime operation assumed in an ST power plant.

Near Term ~5 years

- NSTX and MAST research programs plan to verify the physics metrics for the first-stability regime for DTST and VNS, which do not require active profile and mode control. The programs further plan to clarify the physics metrics for the advanced physics regime for a power plant, which requires detailed control and optimization of ST plasma properties.
- Design studies for the DTST and the ST VNS can be carried out, incorporating technologies already available or developed for the International Thermonuclear Experimental Reactor (ITER) Engineering Design Activity (EDA). Existing U.S. R&D facilities can be used to reduce costs for DTST and VNS.
- To improve Q-engineering for ST reactors, compact toroid (CT)-like approaches should be explored to minimize the applied TF via edge current drive (e.g., CHI and Rotamak current drive) while maintaining the desirable ST plasma properties.

Midterm ~20 years

- A DTST would verify the physics metrics for VNS and the reactor in fusion-relevant regimes at very high average plasma pressures ($\infty \beta B^2 \geq 100\% T^2$). Early verification of the advanced physics regime would enable integrated testing of ignited burn and energy technologies, which is the mission of an engineering test reactor (ETR), in a single VNS-size device.
- An ST VNS would be built to extend DTST results to steady state and begin R&D toward establishing the energy metrics, including TFC conductors to resist neutron damage and activation, and fusion blanket and core components.
- Equally important would be progress in theory and computation, fusion technologies and materials, environmental and safety techniques, and advanced systems design to ensure readiness to embark on an ETR.

Long Term >20 years

- An ST ETR (or pilot plant) would be built to demonstrate all metrics for fusion power, including scientific and technological feasibility, energy technology qualification, and safety and environmental soundness.
- The ST configuration would offer for a demonstration reactor (DEMO) a range of unit powers, from the small pilot plant ($P_{DT} \sim 300$ MW, $Q_{eng} \sim 1$) for zero net electricity, to the full-size power plant ($P_{DT} \sim 3000$ MW, $Q_{eng} \sim 4-6$) for 1000 MW in net electricity.

Proponents' and Critics' Claims

Proponents claim that the ST will provide an innovative, low-cost development path to an attractive fusion power source, with relatively simple technology and device maintenance. Disruptions may be less of a problem in the ST relative to the tokamak due to (1) lower magnetic field, (2) the absence of a delicate zero-magnetic-shear point in the plasma, and (3) high q operation. Neoclassical tearing modes may be stabilized by Pfirsch-Schlüter effects, and only very modest rotation is required for shear-flow stabilization of turbulence and rotational stabilization of MHD wall mode.

Critics claim that the modest engineering Q of a 1-GW(e) ST, largely due to the need to drive current in the copper center column, will push it to larger unit size. This may not be attractive in the energy market of the future. The ST could also suffer from disruptions and may have nearly the same size and complexity as a tokamak.

M-7. REVERSED-FIELD-PINCH CONCEPT

Description

The reversed-field-pinch (RFP) is a toroidal, axisymmetric, magnetically confined plasma. At first glance, the RFP looks much like a tokamak, but its substantial differences could lead to lower cost fusion. As in a tokamak, the RFP fusion plasma is confined by a helical magnetic field composed of both toroidal and poloidal components. Unlike a tokamak, plasma current generates most of the field, and the toroidal component is small and points in opposite directions in the edge and center of the plasma. This reversal of the toroidal field within the plasma leads to unique behavior and gives the RFP its name. The RFP's advantages, which could lower the cost of a fusion power plant, stem from the smaller toroidal magnetic field: (1) nonsuperconducting magnet construction, (2) lower field and forces at the magnet coils, (3) naturally large beta value, (4) high power density, and (5) possibility for Ohmic heating to ignition, and (6) simple assembly. Studies that project RFP plasmas to fusion conditions confirm that these features could reduce the cost of a fusion power plant, but such projections are relatively uncertain because the RFP is not as developed as the tokamak. RFP contributions to plasma science are especially important in topics such as magnetic relaxation, reconnection, dynamo, nonlinear coupling of magnetohydrodynamic (MHD) modes, inertial range MHD turbulence, and transport from magnetic stochasticity.

Status

Recent advancements in the scientific understanding of the RFP have led to an identification of possible solutions to many of the challenges confronting the RFP as a reactor concept. In the laboratory, multifold improvement in the heating and confinement performance of RFP plasmas is being realized in new experiments motivated by this understanding. In particular, the RFP's smaller magnetic field has greater susceptibility to magnetic turbulence. RFP research is providing a wealth of information on the behavior of plasmas with strong magnetic turbulence, from which new strategies for controlling plasma turbulence are being formulated and tested. Fundamental turbulence-related phenomena, such as magnetic relaxation and dynamo field generation, connect the RFP's unique terrestrial laboratory to similar processes occurring in stellar and planetary magnetic fields.

The RFP program is one of three under consideration for proof-of-principle (PoP) status in the United States. Experimental research is undertaken at the Madison Symmetric Torus (MST) facility (1.5-m major radius, 0.52-m minor radius) at the University of Wisconsin–Madison. A small, low-aspect-ratio experiment is proposed to be constructed at the Princeton Plasma Physics Laboratory (PPPL). A small theoretical research effort (~3 person-years per year) is distributed in three to four laboratories.

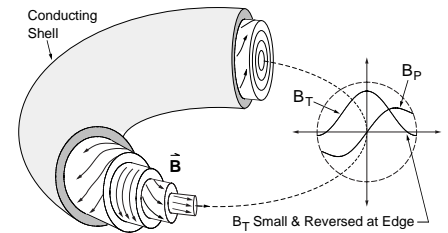

Magnetic field structure of the RFP.

Current Research and Development (R&D)

R&D Goals and Challenges

The key outstanding scientific and technical issues in RFP research are (1) understanding and improving confinement using advanced techniques such as current, pressure, and flow profile control; (2) determining the beta limit; (3) developing efficient current sustainment; (4) controlling resistive shell MHD instabilities; (5) power and particle handling; and (6) maximizing performance through configurational modifications, such as optimizing shape and aspect ratio. The proposed, favorably peer-reviewed, PoP program addresses most of these issues.

Related R&D Activities

In addition to MST in the United States, similar sized RFP experiments operate in Italy (RFX facility) and in Japan (TPE-RX facility). A smaller, resistive-shell RFP experiment operates in Sweden (Extrap-T2 facility). This worldwide RFP program is reasonably well coordinated through an International Energy Agency (IEA) working agreement.

Recent Successes

- Well-developed resistive MHD theory of the RFP, including the MHD dynamo (self-generation of current).
- Experimental confirmation of the MHD dynamo active in the RFP core and collisionless edge.
- Experimental determination that magnetic turbulence drives energy and particle flux in the core.
- Fivefold energy confinement improvement by halving magnetic turbulence using current profile control.
- Confinement improvement associated with induced and spontaneous changes in plasma flow and flow shear.

Budget

DOE–OFES: FY 1998 = \$2.83M, FY 1999 = \$3.53M; proposed PoP budget = ~\$10M/year.

Anticipated Contributions Relative to Metrics

Metrics

- All RFP experiments operate routinely with beta $\sim 10\%$, and in best cases up to $\sim 20\%$. The RFP is one of a few configurations that support the plasma pressure gradient by large magnetic shear, yielding theoretical ideal MHD interchange stability for beta $< 50\%$. Attractive reactor scenarios require beta $\sim 20\%$.
- The minimum global heat conductivity achieved to date is $\chi \sim 10 \text{ m}^2/\text{s}$ (energy confinement time $\tau_E \sim 5 \text{ ms}$) in plasmas with reduced magnetic turbulence through transient current profile control, a roughly fivefold improvement relative to a conventional RFP. Cases with up to threefold improved confinement associated with plasma flow changes occur spontaneously and with plasma biasing. The most recent RFP reactor study (TITAN) assumed an energy confinement time of 200 ms, smaller than typical tokamak reactor studies because a large plasma density is believed possible in the RFP.
- The magnetic field utilization efficiency in the RFP is high because most of the confining magnetic field is produced by plasma current. The field is maximum at the plasma center, with a value about 2.5 times larger than at the plasma boundary. The external magnet force and field requirements are therefore relatively small. The TITAN reactor study assumed a current of 18 MA ($B_{\text{coil}} \sim 5 \text{ T}$), and ≤ 1 -MA experiments are under way ($B_{\text{coil}} \leq 0.5 \text{ T}$).
- To take full advantage of the RFP's compact reactor potential, first walls capable of withstanding large heat flux ($\sim 5 \text{ MW}/\text{m}^2$) and deuterium-tritium (D-T) neutron flux ($\sim 20 \text{ MW}/\text{m}^2$) must be developed. Pioneering ideas for highly radiating plasma boundaries to symmetrize the heat flux evolved from RFP reactor studies.
- Empirically, RFP plasmas do not suffer current disruptions as observed in tokamaks. This could result from the larger magnetic turbulence in the RFP. With progress in turbulence suppression, disruptions could appear.

Near Term ≤ 5 –10 years

- The observed beta in experiments is not believed to be limited by pressure-driven instability; rather, it reflects large transport in Ohmic-only heated plasmas. Auxiliary neutral beam and radio frequency (rf) heating are proposed to control directly the plasma pressure and to determine the beta-limiting physics.
- To minimize magnetic turbulent transport, precise, nontransient current profile control using electrostatic and rf current drive schemes are being developed and tested. The influence of plasma flow on turbulence and transport in the RFP is a new research topic that will be developed theoretically and exploited experimentally.
- Oscillating field current drive, a potentially highly efficient steady-state current sustainment technique, will be tested. This technique may not be consistent with requirements to reduce magnetic turbulence, so additional ideas are being sought for testing.
- Almost all RFP experiments have been circular in cross section with an aspect ratio $R/a \geq 3$. Optimization of the cross-sectional shape and aspect ratio will be explored theoretically and tested experimentally, most likely with new, smaller devices.
- MHD kink modes are expected to grow on the flux diffusion time scale of the conducting shell surrounding the plasma. If such modes arise, control techniques will be devised using plasma rotation, active feedback, or smart shell techniques. This effort should be cooperative with R&D for the control of similar instabilities in advanced tokamaks, spherical tokamaks, and other high-beta configurations.

Midterm ≤ 10 –20 years

- A successful PoP program warrants a next step, high-current, long-pulse, proof-of-performance facility with the necessary systems integrated to assess fully the scientific and technological readiness of the RFP reactor concept. Key technologies in power and particle handling, which do not limit existing device operation or the proposed PoP program, would be developed at this stage, as has occurred in tokamak research.
- As the optimization of the RFP proceeds, reactor studies will be updated to assess the impact of added system complexity on reactor cost. This will help guide the future of RFP research. The reduced Lorentz force stresses implied by the RFP's smaller field requirements could make a pulsed reactor scenario economical and reduce the demands on current sustainment. Advanced liquid-metal blanket concepts are well-suited to the RFP.

Proponents' and Critics' Claims

Proponents claim that the RFP's smaller toroidal magnetic field requirement could lead to an easily assembled, compact, high-power-density reactor. These cost-saving features have been verified in reactor system studies based on to-be-verified extrapolations of RFP results.

Critics claim that the RFP's small toroidal field permits inherently larger turbulence and transport, which could prevent achieving high power density RFP plasmas. Steady-state current sustainment is more difficult in an RFP because the required current is large and the plasma pressure-driven (bootstrap) current is small when the dominant magnetic field component is poloidal.

M-8. SPHEROMAK

Description

- The spheromak is a compact magnetofluid configuration of simple geometry with attractive reactor attributes, including no material center post, high engineering beta, and sustained steady-state operation through helicity injection. It is a candidate for liquid walls in a high-power-density reactor.
- It has a toroidally symmetric equilibrium with toroidal and poloidal fields of comparable strengths. The simplicity and compact size provide good diagnostic access, and spheromaks are relatively inexpensive to build.
- Magnetic helicity (linked magnetic fluxes) plays an important role in forming and sustaining spheromaks. An initial configuration with sufficient helicity and energy will spontaneously relax to a spheromak given appropriate boundary conditions.
- Electrostatic helicity injection has been demonstrated to sustain the spheromak current efficiently via a magnetic dynamo involving flux conversion and has been implemented in several experiments.

Status

- Previous experiments have demonstrated the basic tenets of the spheromak: self-organization at constant helicity; control of the tilt and shift modes by shaped flux conservers; and sustainment by helicity injection, including the role of magnetic fluctuations and reconnection in current drive via the magnetic dynamo.
- Spheromaks were inductively formed without close-fitting walls in S-1 and their global stability maintained by passive figure-eight walls. The relationship of relaxation phenomena and confinement was studied on S-1 and CTX.
- Several groups attained electron temperatures above 100 eV in decaying plasmas, with CTX reaching 400 eV. This experiment had a high magnetic field (>1 T on the edge and ~3 T near the symmetry axis).
- Analysis of CTX found the energy confinement in the plasma core to be consistent with Rechester-Rosenbluth transport in a fluctuating magnetic field, potentially scaling to good confinement at higher electron temperatures.
- The SPHEX group (Manchester, England) studied the dynamo in sustained spheromaks in a cold plasma.
- The Sustained Spheromak Physics Experiment (SSPX) at Lawrence Livermore National Laboratory (LLNL) is addressing the physics of a midscale sustained spheromak with tokamak-quality vacuum conditions and no diagnostics internal to the plasma.
- Supporting spheromak experiments are the Swarthmore Spheromak Experiment (SSX) (reconnection) and the Caltech Helicity Experiment (spheromak formation issues). The fundamental physics of reconnection is being studied in MRX at Princeton Plasma Physics Laboratory (PPPL). The Helicity Injected Torus (HIT) at University of Washington studies coaxial helicity injection in a tokamak.

Current Research and Development (R&D)

R&D Goals and Challenges

- Improve understanding of the coupling of the helicity injector to the spheromak and how to sustain it with minimum perturbation to the axisymmetric configuration, optimizing helicity current-drive efficiency.
- Achieve T_e of several hundred electron volts in a sustained spheromak, and understand the physics of energy confinement in the presence of the magnetic dynamo during sustainment; use this understanding to improve confinement.
- Determine the beta-limiting processes in the spheromak plasma, and maximize the beta.
- Understand and control the processes that determine the properties of the edge/boundary plasma, including the role of edge current density in helicity injection into the core plasma, atomic and molecular processes, instabilities, impurity generation, and other effects due to wall interactions.

Related R&D Activities

- The reversed-field-pinch (RFP) depends on much of the same physics as the spheromak (e.g., magnetic dynamo), but with an applied toroidal magnetic field and different unstable magnetic modes due to the different safety factor profile.
- Compact tori used in fueling experiments for tokamaks are small spheromaks accelerated to high velocity.
- Magnetic reconnection, studied in spheromak experiments and modeling, is a fundamental physics issue applicable to astrophysics as well as to helicity current drive in fusion confinement configurations.
- The spheromak is a possible target plasma for magnetized target fusion.

Recent Successes

- MRX and SSX merged spheromaks and studied the magnetic reconnection and generation of energetic plasma flows. On MRX, the three-dimensional (3-D) structure of the reconnection layer has been extensively studied. SSX is examining the 3-D structure of the reconnection layer and the generation of energetic ions.
- The 3-D movies of the Caltech Helicity Experiment show very clearly the time evolution of the twisted magnetic flux tubes emanating from the muzzle of the coaxial spheromak gun.
- Initial spheromak modeling using the NIMROD resistive magnetohydrodynamic (MHD) code has demonstrated buildup of closed time-averaged magnetic surfaces from a current column in a cylindrical flux conserver.

Budget

DOE-OFES: FY 1998, 1999 = \$1.5M/year for SSPX. Los Alamos National Laboratory (LANL) is funded (\$0.1M) to collaborate on SSPX. An LLNL project on spheromak physics is funded at \$1.05M this year with internal R&D funds; this money needs to be replaced by additional Office of Fusion Energy Sciences (OFES) funds for the project to progress at a reasonable rate. There is presently no funding of theoretical support for spheromak research.

Anticipated Contributions Relative to Metrics

Metrics

- Confinement parameter/required level (power plant): Values similar to other magnetic confinement configurations are required for a power plant. In previous experiments, confinement has been poor due to magnetic fluctuations. Theory indicates that the dynamo can be sustained at very low magnetic fluctuation levels for reactor conditions. If achieved, confinement may be determined by electrostatic fluctuations, not yet studied in spheromaks.
- Reactors require beta $\sim 10\%$. Peak beta $>20\%$ was demonstrated in CTX, and spheromak configurations stable to the Mercier criterion have been modeled with $\beta_p = 1$. However, the lowest energy configurations (Taylor state) generally have low beta (few percent), and the consistency of high-beta configurations with low magnetic fluctuation levels remains to be demonstrated.
- $B(\text{plasma})/B(\text{max coil}) \approx 1$.
- $P(\text{heat-wall})/\text{area}$: In spheromaks with conventional walls, this condition is similar to other magnetic confinement devices. The simple geometry may allow liquid walls and a much more compact reactor.
- $\text{Beta}(\%) \times [B_{\text{plasma}}(\text{T})]^2$ is potentially high, but difficult to evaluate given physics uncertainties.
- Uncontrolled shutdown frequency: No plasma-driven shutdown mechanisms have been identified.
- Power and particle handling: A divertor is naturally formed in spheromaks, allowing handling of power and particles. The close-fitting wall may limit power handling at a level not presently quantified.
- Fundamental physics: Extend understanding of helicity, reconnection, and magnetic dynamo current drive.

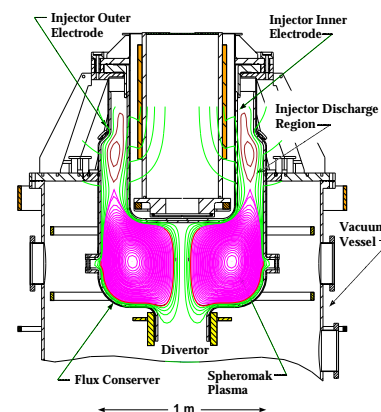

SSPX spheromak, showing MHD equilibrium

Near Term ≤ 5 years

- The SSPX experiment is in the final stages of construction. SSPX is designed to study the confinement in a short-pulsed, sustained device; to relate this confinement to magnetic fluctuation physics; and to extrapolate confinement to larger, long-pulse spheromaks and to possible reactors.
- Understanding of reconnection physics explored in smaller devices (e.g., SSX) will be applied to the confinement experiment, and results from the confinement experiment will be applied to space plasmas. Close collaborations with RFPs and spherical tokamaks (STs) should yield synergistic advances in common physics.
- Beta limits will be studied as a function of the current profile and other parameters in SSPX.
- A divertor will be used in SSPX to evaluate power and particle handling requirements and techniques.
- The need for feedback control of the tilt and shift instabilities in long-pulse experiments and reactors will be evaluated and the development of any needed feedback system started.
- A long-pulse experiment will be designed and proposed before the end of the 5-year period to build on successful results. It will study instability control, beta limits, and use of external poloidal-field coils to evaluate $B(\text{plasma})/B(\text{max coil})$.

Midterm ~ 20 years

- A long-pulse experiment will extend performance and address spheromak physics in the kiloelectron-volt temperature range. Issues will include confinement scaling, beta limits.
- Advanced helicity drive techniques will be developed. Other current drive techniques will be evaluated.
- Technology needs for innovative spheromak reactors will be developed. Possible options include liquid walls of lithium and fluorine-lithium-beryllium (Flibe). $\beta_p \sim 1$ may be possible in a repetitively pulsed reactor.

Long Term >20 years

- A proof-of-performance experiment will be conducted.
- Innovative reactor concepts (e.g., pulsed, high-beta reactors with liquid walls) could lead to early deployment of a power reactor based on the spheromak concept.

Proponents' and Critics' Claims

Proponents claim that the spheromak leads to a potentially compact and simple reactor, with a potentially efficient current drive using coaxial (or other) helicity injection. The physics studied in the spheromak may also contribute to other concepts such as the RFP and is pertinent to studies of interstellar plasmas.

Critics claim that the spheromak may not have adequate confinement for a power plant and that there is no fully demonstrated way to sustain the plasma current for long pulses.

M-9. FIELD-REVERSED CONFIGURATION

Description

A field-reversed configuration (FRC) is a compact toroidal plasma with negligible toroidal magnetic field. It is usually fairly elongated, contained in a solenoidal magnetic field, and possesses a simple, unobstructed divertor. The plasma beta is close to unity, and an FRC is thus both extremely compact and geometrically simple. The essentially diamagnetic current can be primarily sustained by central fueling, but some augmentation will be required at the field null. The observed stability in present experiments is thought to be due to kinetic effects, which have been characterized by a parameter s , equal to the number of ion gyro-radii between the field null R and the separatrix r_s . The utility of the concept depends on demonstrating stability as s is increased from present values of about 4 to the 20–30 levels thought needed to provide reactor level confinement. The enhancement of kinetic stabilization, either through addition of energetic particles (e.g., ion ring merging or neutral beam current drive) or naturally occurring fusion reaction particles, may be an essential component of the concept, although there is some theoretical and experimental evidence that FRCs may be naturally occurring minimum energy states stabilized by sheared rotation akin to spheromaks and reversed-field-pinch (RFP) devices when total helicity (including angular momentum) is conserved.

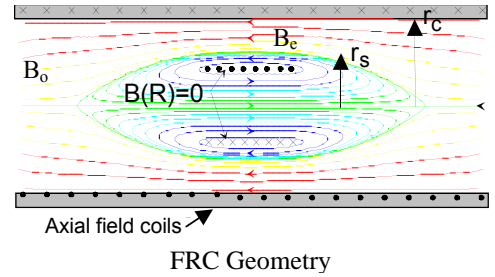

Status

The FRCs have been formed with high plasma pressures in theta-pinch devices. Without an external current drive, these current rings decay on sub-millisecond L/R times. Due to typical densities of $5 \times 10^{21} \text{ m}^{-3}$, $n\tau$ products of close to $10^{18} \text{ m}^{-3}\text{s}$ have been achieved in FRCs with major radii of 15 cm at several 100-eV temperatures. Lifetime has been observed to increase with density: shorter lived FRCs are easily produced at $n \sim 10^{21} \text{ m}^{-3}$ with kiloelectron volt temperatures. Stable FRCs with s values of up to 4 and poloidal fluxes of 10 mWb were produced in a Large s Experiment (LSX), which was built from 1986–1990, but only operated for 1 year due to reductions in funding for alternate concepts at that time. Rotating magnetic fields (RMFs) have formed and sustained FRCs in small rotamak experiments in Australia and will be applied to a modified version of LSX [Translation, Confinement, and Sustainment (TCS) experiment] to attempt to increase the flux and sustain the configuration in quasi steady state.

Current Research and Development (R&D)

R&D Goals and Challenges

The principal R&D goal is to develop an understanding of the highly unique physics of this extremely attractive reactor configuration. The principal technological challenge is to produce hot, higher s FRCs and sustain them for sufficient time to study their properties. A list of specific goals and challenges follows:

- Form large, low-density FRCs by translating and expanding theta-pinch-formed FRCs.
- Increase the flux and produce higher s FRCs by applying high-power RMF.
- Develop fueling and heating methods to go along with RMF current drive.
- Sustain hot FRCs with moderate s values for millisecond timescales.
- Develop specialized diagnostics for internal profile measurements.
- Develop an efficient technology for both forming and sustaining hot, high flux FRCs.
- Develop a theoretical understanding of FRC stability in its unique kinetic regime, and develop sufficient understanding of FRC confinement to allow confident extrapolation to larger devices.

Related R&D Activities

- RMF theory in Japan and possible RMF current drive on spherical torus.
- U.S.–Japan FRC research coordination and low-density confinement studies at Osaka University.
- U.S.–Japan studies on D-³He reactor—ARTEMIS beam-driven design with direct conversion.
- NASA-sponsored studies of simpler formation techniques for space propulsion.
- Ion ring generation studies at Cornell University.
- Merging spheromak experiments at Princeton Plasma Physics Laboratory (PPPL).

Recent Successes

- Production of stable $s = 4$ FRCs in LSX.
- Production of low-density FRCs with enhanced confinement in Osaka FIX experiment.
- Translation and acceleration of FRCs in Tokamak Refueling by Accelerated Plasmoids (TRAP).
- Steady state (40-ms) RMF formation and sustainment of FRCs and spherical torus in Australia.
- Formation of hot FRCs through merging of opposite helicity cold spheromaks at PPPL and Tokyo University.

Budget

- DOE–OFES: FY 1998 = \$1.5M, and FY 1999 = \$1.5M.
- NASA: FY 1998 = \$100K, and FY 1999 = \$75K.

Anticipated Contributions Relative to Metrics

Metrics

The FRC is extremely compact, has near unity beta, plus a simple solenoidal magnet system. To realize its high reactor promise, stability must be demonstrated at high s , and the present empirical confinement scaling must be improved at low densities. The technology must also be developed to produce higher flux FRCs and to sustain them. This includes heating and fueling in addition to current drive.

Near Term ~5 years

The theta-pinch-formation technique is capable of forming somewhat higher flux FRCs than the 10 mWb presently demonstrated in LSX, but the method is technologically limited to the tens of milliweber level. Several weber will be required for a reactor. Some method of both flux buildup and sustainment is needed for the continued development of the concept. The RMF approach is not technologically limited for either flux buildup or sustainment, and high-power RMF will be applied to hot, theta-pinch-formed FRCs in a collaboration (TCS experiment) between the University of Washington and Los Alamos National Laboratory.

The FRC stability theory has advanced to the point where combinations of profile shaping and gyro-viscous effects can account for the presently observed stability. Progress is also being made on understanding the tendency of counter-helicity spheromaks to merge into a higher temperature FRC. Sheared flow may perform the same stabilizing function as magnetic shear in more conventional magnetic confinement schemes. Ponderomotive forces due to the RMF are also thought to provide stabilizing properties, although the theoretical understanding of this exciting technique, as applied to hot FRCs, is only in its infancy. A coordinated approach to the development of stability theory for the unique FRC confinement scheme is now underway in a multi-institutional effort led by PPPL.

Empirical scaling laws have been developed to reflect experimental FRC confinement times in high-density experiments, but no theory exists to adequately explain this scaling. The empirical diffusivity, $D \sim 5 \text{ m}^2/\text{s}$, is adequate for high-density pulsed reactors but must be reduced by about an order of magnitude to realize more desirable, low-density, small compact reactors. There is some evidence of better low-density confinement in Japanese experiments (FIX), and this will be explored in the TCS program where lower densities are reached through translation and expansion.

As currently funded, most of the experimental burden for FRC development will fall on the newly constructed TCS facility. It is particularly important that facilities other than TCS alone should undertake FRC research to fully explore the many facets of its unique physics. PPPL has proposed the SPIRIT facility to form FRCs by merging opposite helicity spheromaks. This facility would allow modification of the FRC shape (from prolate to oblate) and eventually provide for neutral beam fueling that could both sustain the configuration and increase the kinetic ion component. It would also be useful if the technology for producing field-reversing ion rings at Cornell was further developed, in case it was needed for stabilization.

Midterm ~20 years

If RMF current drive were successful, very rapid progress could be made because reactor level magnetic fields are only on the order of a few tesla in simple solenoidal magnets, and the required RMF power is not expected to increase significantly with device size. The 80-cm-diam TCS facility could be extended somewhat to the $s \sim 10$ levels by extending the pulse length of the RMF power supplies and developing fueling methods. A larger ~\$50M facility should be built at a national laboratory to produce steady-state FRCs with thermonuclear temperatures. With success, capabilities could be rapidly increased to the level of those proposed for the International Thermonuclear Experimental Reactor.

Long Term >20 years

The remaining technologies relevant to any deuterium-tritium fusion device, mainly a first wall and tritium-producing blanket, would need to be developed. To realize the ultimate potential of the FRC concept, the use of more aneutronic fuels should be investigated. The principal technology here would be an efficient direct converter.

Proponents' and Critics' Claims

Proponents claim that FRCs are the most attractive of all magnetic confinement schemes and that their unique physics is largely unexplored. Many nonideal magnetohydrodynamic (MHD) effects are present that could lead to maintenance of stability even at large s . It is hoped that if the RMF current drive scheme is successful, FRCs will no longer be regarded as mere pulsed curiosities by other fusion researchers. Critics claim that that FRCs are mere pulsed curiosities lacking basic MHD stability and that they are only stable due to their present small size and low s number.

M-10. LEVITATED DIPOLE FUSION CONCEPT

Description

The dipole magnetic field is the magnetic field far from a single, circular current loop. The use of a dipole magnetic field to confine a hot plasma for fusion power generation was first considered by Hasegawa (*Comm. Plasma Physics*, 1987). In this configuration, a relatively small superconducting ring floats within a large vacuum chamber. The dipole confinement concept is based on the idea of generating pressure profiles having gentle gradients and being stable to all low-frequency magnetic and electrostatic fluctuations. From ideal magnetohydrodynamic (MHD) conditions, marginal stability results when the pressure profile satisfies the adiabaticity condition, $\delta(pV^\gamma) \geq 0$, where V is the flux tube volume and $\gamma = 5/3$. For usual magnetic confinement devices, this constraint can not be satisfied, and MHD stability must be provided by field-line averaging and magnetic shear. In contrast, because of the large dimensions of the dipole plasma on the outer radius of the levitated coil, the pressure profile can scale with radius as rapidly as $R^{-20/3}$ and still remain absolutely MHD stable to beta of order 100%. Because the coil set for a possible dipole fusion power source is very low weight and axisymmetric, operation is inherently steady state, easy to maintain, and potentially of low unit cost. Because the dipole concept permits high beta without magnetic shear, the concept may allow removal of fusion products without degrading energy confinement and thus be appropriate to advanced fusion fuels, such as D-³He. Conceptual reactor studies have supported the possibility of an attractive fusion power source using a levitated dipole.

Status

- The scientific literature for dipole confinement includes space-based observations and theory, laboratory experiments, and fusion theory. This understanding establishes a bridge from the high-beta confinement observed in planetary magnetospheres to the confinement expected in levitated dipoles—where hot plasma will be confined for many collision times. The understanding gained from decades of space plasma research supports the levitated dipoles as a fusion confinement device. Approximately a dozen studies have been published specifically addressing the use of dipole-confined plasmas for energy production or space propulsion. Finally, the CTX device at Columbia University has illustrated the stability properties of collisionless energetic electrons confined by a dipole magnetic field.
- The first experiment to investigate the levitated dipole concept is presently under construction at the Massachusetts Institute of Technology (MIT) as a joint project between Columbia University and MIT. First plasma is expected in the year 2000.

Current Research and Development (R&D)

R&D Goals and Challenges

An essential first step for the understanding of the scientific feasibility of a levitated dipole is a laboratory test of confinement properties of such a device. The Levitated Dipole Experiment (or LDX) has been designed to test the scientific feasibility of levitated dipole confinement at high beta. Construction of the experiment began in July 1998. A major technical challenge has been met through the collaboration between superconducting magnet technology experts and innovative experiment design: a large current (1.3 MA) must be sustained in a ring having low mass. Another challenge is to complete more detailed modeling of dipole power sources. Limited reactor engineering studies are now under way.

Related Research Activities

The conceptual development of the dipole fusion power source has been inspired by space plasma studies and planetary exploration. Continued exploration of magnetospheric plasmas (e.g., the exploration of the Io plasma torus that surrounds Jupiter and the development of physics-based models of space weather) will add to the cross-fertilization of this area of plasma science. Although the dipole plasma confinement concept is a radical departure from the better known toroidal-based magnetic confinement concepts, a scientific investigation of magnetized plasma confinement with high compressibility will add insight to these other more traditional confinement concepts. In the technology area, the development of advanced and high-temperature superconductors will aid significantly in the reactor conceptualization of a dipole power source. Experiments to investigate low-density, nonneutral plasma confinement with a levitated dipole device are planned for the University of Tokyo.

Recent Successes

The engineering design of the LDX facility is almost complete. The major fabrication items, including the vacuum chamber and the floating coil, are either under construction or awaiting final selection of the vendor. Theoretical research supporting the possibility of classical confinement in a dipole-confined plasma was recently published.

Budget

The LDX project budget in FY 1999 is \$1.2M, which is divided between Columbia University and MIT.

Anticipated Contributions Relative to Metrics

Metrics

The levitated dipole confinement concept has the potential to be an attractive fusion power source while at the same time contributing to the understanding of magnetospheric physics. The relative simplicity of the magnetic field structure and the good understanding of plasma confined in planetary magnetospheres indicate that plasmas confined by levitated dipole magnets will have (1) high peak beta ($\geq 50\%$) and volume-averaged engineering beta ($\geq 10\%$), (2) excellent field utilization ($\geq 90\%$), and (3) possibly sufficient confinement to ignite D-³He fuel. Because the plasma equilibrium and magnetic geometry are essentially determined by sustainable current in superconducting magnets, the dipole fusion concept is disruption free and promises to be highly reliable. Because (1) the particle flux to the floating ring is 100% recycled, (2) the shear-free magnetic field allows convection of fusion ash without energy confinement degradation, and (3) the outer plasma surface is open, accessible, and naturally diverted, power and particle handling should be superior to other magnetic confinement concepts. The dipole is best suited for D-³He fusion fuel, and this may lead to a reduction in fusion's adverse impact on the environment.

Near Term ≤ 5 years

For the first time in the laboratory, high-beta plasma having near classical energy confinement scaling for time scales long compared with particle and energy confinement times will be investigated. Experimental observations will be compared with theory. For this purpose, the LDX has been conceived and designed as the lowest cost approach for investigating the key physics issues while simultaneously maintaining high confidence of its technical success. The experimental approach takes two stages. First, multiple-frequency electron cyclotron resonance heating (ECRH) (with frequencies between 6 and 28 GHz) will be used to produce a population of energetic electrons at high $\beta \sim 1$. This technique has been proven effective in magnetic mirror experiments (e.g., Constance and Tara). Based on experience generating hot electrons within mirrors and within CTX, the creation and maintenance of high-beta plasmas using a few tens of kilowatts of ECRH power is expected. Secondly, after formation of the high-beta hot electron plasma, fast deuterium gas puff techniques or the injection of lithium pellets will be used to thermalize the energy stored in the hot electrons and to raise the plasma density. The resulting thermal plasma will provide a test of the MHD limits and of the confinement of a thermal plasma in a levitated dipole.

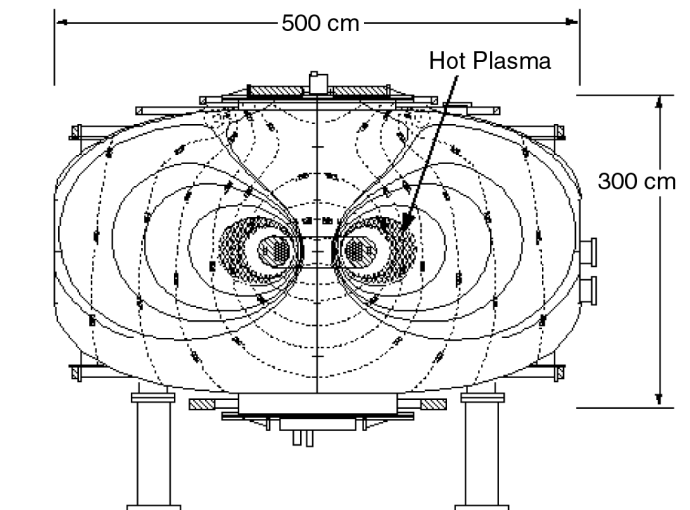

Midterm ~ 20 years

Proof-of-principle dipole confinement experiments that operate with plasma parameters resembling those which might be found in fusion power sources need to be designed and constructed. Better understanding of the possibility of practical sources of ³He fuel need to be achieved.

Long Term >20 years

Successful operation of a fusion power source and an assessment of the applicability of D-³He dipole fusion for commercial energy and for spacecraft power and propulsion are long-term objectives.

Proponents' and Critics' Claims

A dipole power source has the possibility of being steady state with classical confinement and high beta. Compared with a tokamak it would not require current drive; it is disruption free; and it has a natural divertor. The dipole has a relatively simple magnetic configuration that does not have interlocking coils. Critics challenge the practicality of a floating ring within a fusion plasma. In a reactor embodiment, the large diameter of the outer wall may result in an undesirable small power flux (although a number of design options could ameliorate this problem). Convective cells could lead to enhanced transport; however, at marginal profiles they may provide a means to fuel and to remove ash. The dipole concept is most compatible with the burning of advanced fuels, such as D-³He, and this fuel simplifies some of the technologies required for dipole fusion power sources. Critics argue that the need for lunar mining or ³He breeders to provide adequate supplies of fusion fuel will add significantly to the cost of commercial dipole fusion power systems.

M-11. OPEN-ENDED MAGNETIC FUSION SYSTEMS

Description

- Open-ended magnetic fusion systems are a generalization of the classic magnetic mirror. In the “classic” system, plasma is confined radially by the magnetic field and axially by the reflection from regions of high magnetic field due to the constancy of the magnetic moment. Magnetohydrodynamic (MHD) stability to interchange modes is provided by quadrupole (or higher) magnetic fields, which generate a minimum in the magnetic field.
- To enhance axial confinement, the tandem mirror generates electric potentials, which traps ions and/or electrons. The potentials are essentially ambipolar in nature, with one or both particle species having a non-Maxwellian component.
- An approach that has been investigated is the multimirror system, in which end losses are limited by coupling a series of short mirror cells at each end of a longer central cell. To escape from confinement, the particles must diffuse from cell to cell so that if certain conditions are satisfied, the confinement time increases at least as the square of the number of end cells.
- Another approach is the gas dynamic trap (GDT), in which the bulk plasma is collisional. This plasma is confined in an axisymmetric magnetic field, with MHD stability generated by the flow of plasma in the good-curvature region where the field expands outside the mirror. One possible application of the GDT is to a neutron source (see M-19. Volumetric Neutron Source and M-12. Gas Dynamic Trap for details).
- New concepts could also provide enhanced axial confinement, for example, the kinetic tandem concept, which uses energetic ion beams injected into the magnetic field from the ends with sufficient perpendicular energy to provide high-density, high-potential regions where the ions reflect from regions of strong magnetic field. In a sufficiently long linear system, net power could be produced.

Status

- Tandem mirror research is being conducted on Gamma-10 in Tsukuba, Japan, using both ion cyclotron resonance heating (ICRH) and electron cyclotron resonance heating (ECRH) to heat the plasma and provide the non-Maxwellian distributions necessary to enhance confinement. The plasma density is typically about $2 \times 10^{19} \text{ m}^{-3}$, central-cell $T_i \sim 3 \text{ keV}$, and $T_e \sim 100 \text{ eV}$.
- An experiment operating at the Budker Institute of Nuclear Physics, Novosibirsk, Russia, has demonstrated much of the GDT neutron source physics with a pulse length of 3–5 ms: stability against MHD modes, stability against ion velocity–space modes so that the ions decay and scatter classically, and $T_e = 130 \text{ eV}$ (equal to classical predictions for the available neutral beam power—3.5 MW at 15 keV). The device is routinely operated at plasma beta of 30%, without any signs of gross MHD instabilities. Electron energy balance has been shown to be classical within the parameter regime explored to date.
- Several experiments have reported similar confinement parameters. The tandem mirror, TMX-U, had a global energy confinement of $n\tau = 2 \times 10^{16} \text{ s/m}^3$. The ion perpendicular energy (“temperature”) was 2 keV (parallel was about 0.4 keV). Thus, $n\tau T_i$ was $4 \times 10^{16} \text{ keV}\cdot\text{s/m}^3$. Drag on the electrons limited energy confinement in several devices: Gamma-10 has a central cell density of 10^{18} m^{-3} and T_i up to 7 keV (also perpendicular). The energy confinement is limited by drag on electrons, so $\tau \sim 2 \text{ ms}$. Thus, $n\tau T_i = 1.4 \times 10^{16} \text{ s/m}^3$. The GDT at Novosibirsk has $n = 10^{19} \text{ m}^{-3}$, $T_i = 7 \text{ keV}$, and is also limited by drag on relatively cold electrons so that $\tau = 0.4 \text{ ms}$. Thus, $n\tau T_i = 2.8 \times 10^{16} \text{ s/m}^3$.

Current Research and Development (R&D)

R&D Goals and Challenges

- The U.S. has no operating open confinement experiments.
- Research on the GDT is being carried out on the GDT physics and its application to a neutron source at the Budker Institute.
- Research on tandem mirror physics is being conducted at Tsukuba in the Gamma-10 experiment and in the AMBAL experiment at the Budker Institute.
- The Hanbit tandem mirror experiment is being put into operation in Korea.

Budget

There are presently no U.S. funds being spent on open systems.

Anticipated Contributions Relative to Metrics

Metrics

Open-ended systems have demonstrated the possibility of confining plasmas in a near-quiescent state, one where the confinement time approaches the “classical” value, that is, value calculated from collisional processes alone. Until larger facilities are constructed, the metric for subscale open-ended experiments should be the degree to which the confinement time is found to scale in a classical manner. If this scaling is convincingly demonstrated, the extrapolation of small-scale experiments to fusion-relevant scale can be done with a high degree of confidence.

Near Term ≤ 5 years

The most important short-term experiments are those in confinement physics and scaling. The GDT experiments have shown classical confinement in axially symmetric confinement fields. The GDT results could, therefore, be a starting point for the design of a small-scale U.S. experiment. In addition, university-scale experiments could investigate the new approaches and the plasma physics issues that they involve. Because there has been a hiatus in open-ended research in the U.S. program, it will be necessary to rebuild aspects of the intellectual infrastructure that was in place before that hiatus. In parallel with the confinement physics investigations should be work on critical technological issues for open-ended fusion systems, such as direct conversion.

Midterm ~ 20 years

If the near-term experiments verify the predictability of confinement of the new breeds of open-ended systems, scale-up to achieve fusion-relevant conditions would be justified.

Long Term >20 years

Success at fusion scale in the achievement of classically confined plasmas implies fusion power systems that could be much smaller and less complex than present closed systems.

Proponents' and Critics' Claims

Proponents believe that open-ended systems, with their flexibility for innovation, their theoretical tractability, and their demonstrated ability to achieve near-classical (turbulence-free) confinement time, offer the best possibility for overcoming the widely recognized limitations of main-line closed-geometry systems, such as the tokamak.

Critics claim that the electron physics concepts have not been demonstrated at the required temperature, that the Q is small and results in low-power efficiency, and that the mirror physics and technology are deadend developments for fusion power.

M-12. GAS DYNAMIC TRAP

Description

- The Gas Dynamic Trap (GDT) Neutron Source (GDTNS) is a volumetric plasma (14-MeV) source with a neutron spectrum and intensity very close to that predicted for International Thermonuclear Experimental Reactor (ITER) and fusion reactor designs.
- Neutrons are produced by a neutral beam injected at 30° – 45° to the magnetic field in an axisymmetric mirror machine, with most of the neutrons produced at the sloshing-ion turning points near the mirrors (see figure).
- Magnetohydrodynamic (MHD) stability is produced by the outflow of dense plasma through one of the mirrors into a magnetic cusp, with the flow momentum in the good-curvature part of the field dominating the plasma instability drive in the bad-curvature part of the confined volume.
- Calculations and extrapolation of experiments indicate that 1 – 2 MW/m² of uncollided 14-MeV neutrons can be produced in a 100-L volume with small tritium consumption (<150 g/year at 100% availability) and intrinsically steady-state operation.
- Positive-ion-based neutral beams (<65 keV, 60 MW) can be used at mirror fields of 13 T (mirror ratio 10); upgrades to 20 T and 250-keV negative-ion-based neutral beams could produce as much as 4 MW/m² of 14-MeV neutrons.

Status

- An experiment operating at the Budker Institute of Nuclear Physics (BINP), Novosibirsk, Russia, has demonstrated much of the GDTNS physics with a pulse length of 3–5 ms: stability against MHD modes, stability against ion velocity-space modes so that the ions decay and scatter classically, and $T_e = 130$ eV (equal to classical predictions for the available neutral beam power; 3.5 MW at 15 keV).
- The device is routinely operated at plasma beta of 30%, without any signs of gross MHD instabilities. The cross-field transport is nonclassical, but the diffusion coefficient is sufficiently small (for the neutron source applications), less than $5 \times 10^{-3}(cT_e/eB)$.
- A hydrogen prototype of the neutron source has been designed, the experimental hall has been prepared at the BINP (Novosibirsk), and approximately 50% of hardware has been manufactured in the years 1993–1997. A decline in funding has stopped this activity. With \$2M annual funding, this device could be brought into operation by the year 2001. A hydrogen prototype is a full-scale copy of a real neutron source. Its low cost is determined by two factors: the pulsed (0.2–0.5 s) mode of operation and the absence of radioactivity.
- A preconceptual design of the neutron source has been carried out by BINP in collaboration with the Efremov Institute (St. Petersburg, Russia), All-Russian Institute of Technical Physics (Snezhinsk, Russia), and Forschungszentrum Rossendorf (Germany). Issues of tritium handling and neutron shielding have been studied in great detail. The systems for installing and removing the samples from the test zone have been designed.

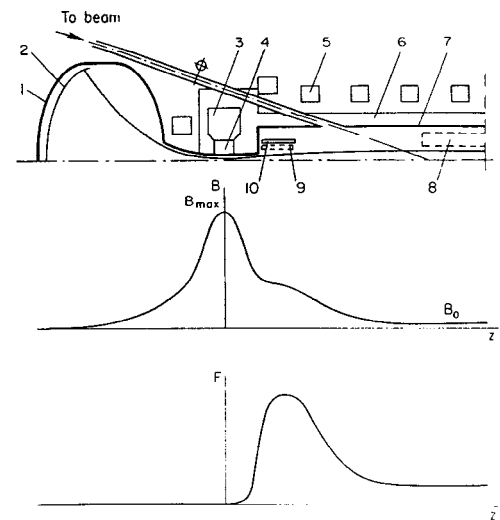

Schematic of GDT based on neutron source: (1) expander vacuum chamber; (2) plasma absorber; (3) superconducting part of the mirror coil; (4) water-cooled part of the mirror coil; (5) one of the coils of superconducting solenoid; (6) shield; (7) vacuum chamber of a mirror coil; (8) zone of a moderate neutron flux; (9) zone of a high neutron flux; (10) neutron reflector. The plots above show the relative magnetic field β and the relative dependence of neutron flux F_N , on the position. Source: D. D. Ryutov, *Plasma Phys. Controlled Fusion*.

Current Research & Development (R&D)

R&D Goals and Challenges

- Research on the GDTNS is being carried out on GDT physics and its application to a neutron source at BINP. This work builds on previous results from there and elsewhere in the world, including on past mirror machines in the United States. The experiment has a mirror-to-mirror length of 7 m, a plasma radius at the midplane of 0.1 m, a magnetic field at the coils of 15 T, and a plasma density up to 10^{20} m⁻³.
- The increase of the magnetic field in the midplane from the present level of 0.22 to 0.5 T has been planned. This would allow considerably improved performance of the device and would broaden the domain for deriving necessary scaling laws. However, the lack of funding (~\$300K for the upgrade) has stopped this activity.

Budget

There are presently no U.S. funds being spent on the GDTNS. The funding to the BINP is low, allowing slow progress on the experiment.

Anticipated Contributions Relative to Metrics

Metrics

Plasma experiments need to demonstrate the full operating regime; magnetic field strength in the mirrors at 13 T, magnetic field ratio of 10, plasma density at $>10^{20} \text{ m}^{-3}$, electron temperature at $>0.5 \text{ keV}$, and neutral beam injection at 65 keV at $30^\circ\text{--}45^\circ$ to the magnetic field at powers extrapolatable to 60 MW. The sloshing-ion distribution must remain stable in the high power system, as predicted by theory.

Near Term ≤ 5 years

Complete the construction of the “Budker hydrogen prototype.” Assistance from the United States in equipment, personnel, or construction funds would greatly speed construction and give the United States a relatively inexpensive opening to explore the development of this neutron source. An international collaboration could draw on the extensive experience at the BINP; together with the U.S. construction capabilities, this would provide a strong basis to evaluate this option for fusion testing.

Midterm ~ 20 years

Build a GDTNS and apply it to the neutron testing and development of materials, components, and reactor systems.

Long Term >20 years

Use GDTNS to test and develop advanced reactor materials and reactor systems, for example, for a DEMO or power reactor.

Proponents' and Critics' Claims

Proponents claim that most of the physics has been demonstrated for the GDTNS, although experiments at higher power are required to verify the extrapolation of the electron temperature to the neutron source regime. The proposed neutron source can test materials, reactor components, and many of the blanket systems and subsystems needed for a reactor. Tritium usage is low enough to be supported from supplies elsewhere in the world, without local production. Construction is relatively straightforward, and the cost is reasonable ($\sim \$500\text{M}$) for a large 14-MeV neutron source. This appears to be one (perhaps the only) path to a true plasma-based 14-MeV neutron source that can be developed in the near future. The resulting neutron flux could also be used in spin-off applications, which would benefit from a 14-MeV primary energy.

Critics claim that the electron physics has not been demonstrated at the required temperature, that the Q is small resulting in low power efficiency, and that the mirror physics and technology are deadend developments for fusion power.

M-13. PLASMAS WITH STRONG EXTERNAL DRIVE

Description

Particle distributions driven, for example, by beams and including the effects of nuclear polarization can provide certain benefits in magnetic fusion devices. Beams of ions, colliding at energies near the peak in their fusion cross section, lead to a higher Q than a thermal distribution of the same mean energy (see Fig. 1 opposite). One important gain is an increase in fusion reactivity at higher energies. This increase may be in the form of a nuclear resonance; hence, such distributions are far better than simply hotter plasmas. The dramatic success of the Tokamak Fusion Test Reactor's (TFTR's) two-component supershot program is one concrete experimental example, displaying not only enhanced reactivity but also improved confinement. Other benefits have been predicted, such as the conversion of fusion products' energy into plasma current, the "alpha channeling process." However, it has also been long recognized that such strongly driven systems may be prone to instabilities or that there may be practical or fundamental difficulties in producing or maintaining the desired distribution. Determining what precise departures from simple thermal distributions are desirable and maintainable merits an extensive research program because of the large magnitude of the potential benefits. The benefits and needs are greatest for high-beta magnetic fusion energy (MFE) devices, for example, the field-reversed configuration (FRC), spheromak, and spherical tokamak (ST). Because of its demonstrated very high beta and potential for direct electrical conversion of the exhaust, the FRC is particularly interesting as a candidate to burn aneutronic fuels (see Fig. 2 and M-20. Alternate Fuels).

Status

In beam-heated tokamaks, the fuel ions are Maxwellian, the electrons are a drifted Maxwellian, and the beam particles have a slowing down distribution. It is an experimental fact that operational modes can be found where the beam particles slow down and diffuse classically while the thermal particles experience anomalous transport. Other energetic particles, such as runaway electrons and radio-frequency (rf)-heated ions, typically strongly non-Maxwellian, have significantly better confinement than the Maxwellian particles in the thermal range of energies. The experimental data base on improved confinement for non-Maxwellian particles is solid and attractive, but the fundamental understanding needs improving for optimization in other configurations.

No similar experiments have been performed on FRCs or spheromaks because of the short-duration pulsed nature of their operation, previous heating methods, relatively high collisionality, and the more limited research programs. First theoretical analyses of colliding beam distributions in FRCs have been carried out, including stability studies. Beam- (and rf-) heating experiments on STs are only now commencing. The theoretical underpinnings of alpha channeling theory are strong. Preliminary alpha channeling experiments were performed on TFTR with mixed results. Definitive comparisons between experiments and theory are still lacking.

Current Research and Development (R&D)

R&D Goals and Challenges

In the United States, there is only a vestigial theoretical research program on alpha channeling and no experimental program whatsoever. There is no Department of Energy (DOE)-supported experimental or theoretical research program on enhancing reactivity by maintaining strongly driven ion distributions.

If an R&D program were to be funded, the major goals would include understanding of the four following issues:

- the fundamental limitations to producing and sustaining non-Maxwellian distribution,
- the stability limits of allowed distributions in the high-beta devices,
- the enhancements to reactivity possible with the attainable distributions, and
- the efficiency for converting non-Maxwellian energy distributions into driven currents.

In Russia, there is research on a beam-driven mirror system for use as a 14-MeV neutron source for materials irradiation testing (see M-12. Gas Dynamic Trap).

Anticipated Contributions Relative to Metrics

Metrics

The principal goals are to develop and test the basic concepts that will allow the most benefit to be derived from non-Maxwellian distributions.

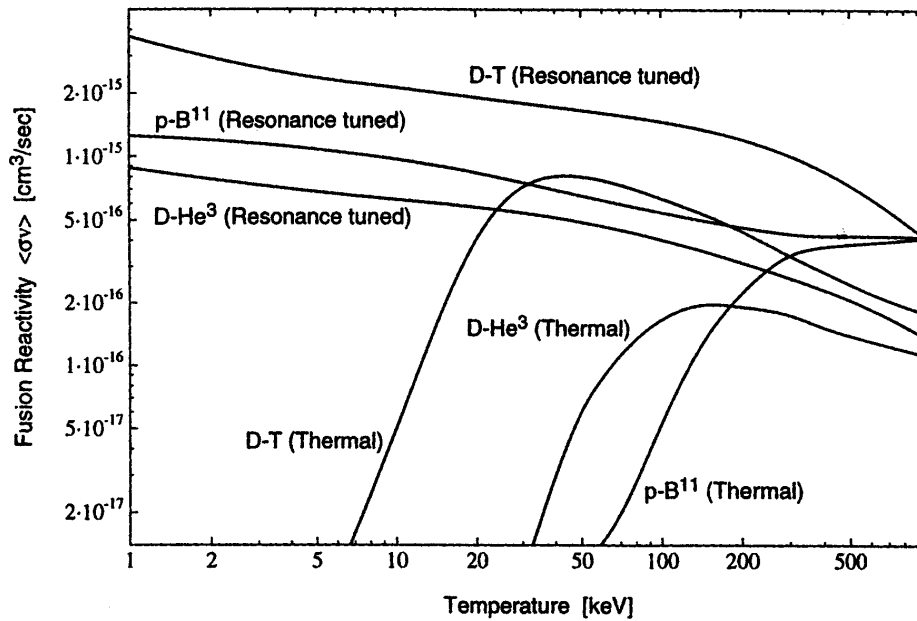

Fig. 1. Various fusion reactivities.

Near Term ~5 years

- Develop and test techniques to divert alpha power of an ST reactor into current drive.
- Develop and test concepts and methods to maintain non-Maxwellian distributions, including beam and rf approaches.
- Perform pulsed experiments in an FRC to test colliding-beam concepts.
- Perform pulsed experiments in an FRC to test rf concepts.

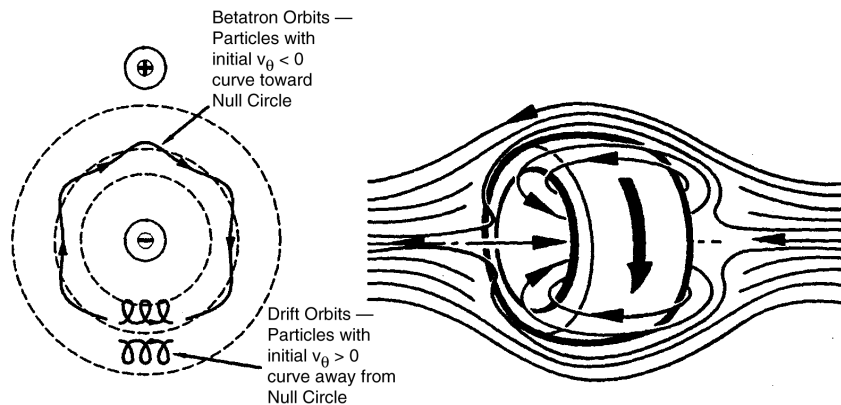

Fig. 2. FRC with typical particle orbits.

Midterm ~5–20 years

Research with periodic state experiments at low power levels and development of a 100-MW prototype.

Proponents' and Critics' Claims

Proponents claim that the benefits of strongly driven plasmas are essential to clean and economic fusion and that the basic aspects of maintaining strongly driven distributions have not been properly examined. Critics claim that a rapid Coulomb scattering rate will not allow such plasma systems to be maintained long enough for benefits to accrue and that technologies to provide the drive are too large, expensive, unreliable, and cumbersome to be practical.

M-14. MAGNETIZED TARGET FUSION

Description

In the magnetized target fusion (MTF) approach to fusion, deuterium-tritium (D-T) fuel in a preheated magnetized target plasma is rapidly compressed to thermonuclear temperatures by pdV heating. For example, the figure shows compression using a metal liner imploded with high velocity (typically a few kilometers per second), resulting from the self-pinching of megampere currents. Operating in a fuel density and time scale regime intermediate between magnetic confinement fusion and inertial confinement fusion has the advantage of allowing orders of magnitude smaller system size compared with conventional magnetic fusion. Magnetic insulation has the potential for orders of magnitude reductions in power requirements compared with conventional inertial confinement fusion. If this avenue to low-cost energy-producing plasmas is successful, MTF permits fusion development without billion-dollar facilities, thus circumventing one of the most serious obstacles to fusion development.

Status

A number of promising target plasma configurations have been identified. Current emphasis on the field-reversed configuration (FRC) derives from 20 years of compact torus research, which provides a good understanding of FRC equilibrium, compressional heating, and confinement scaling. Present understanding projects to near break-even parameters with available pulsed-power facilities. In recent years liner implosion technology, with the required ~10-MJ energy and ~10-km/s velocity needed for MTF, has been developed by Defense Programs (DP) in the Department of Energy (DOE) and the Department of Defense (DOD), and facilities are available to allow very cost-effective tests of the MTF concept. In May 1998 a national team of six institutions led by Los Alamos National Laboratory (LANL) proposed a 3-year, \$6.6M/year proof-of-principle (PoP) test of MTF to DOE. The proposal received favorable peer review, and the Fusion Energy Sciences Advisory Council (FESAC) recommended the team be kept in place while FESAC conducted a review of overall program balance. Since the proposal, the team has grown and now includes LANL, Air Force Research Laboratory, Lawrence Livermore National Laboratory, General Atomics, University of Washington, Westinghouse, Massachusetts Institute of Technology, University of California—San Diego, and University of California—Berkeley.

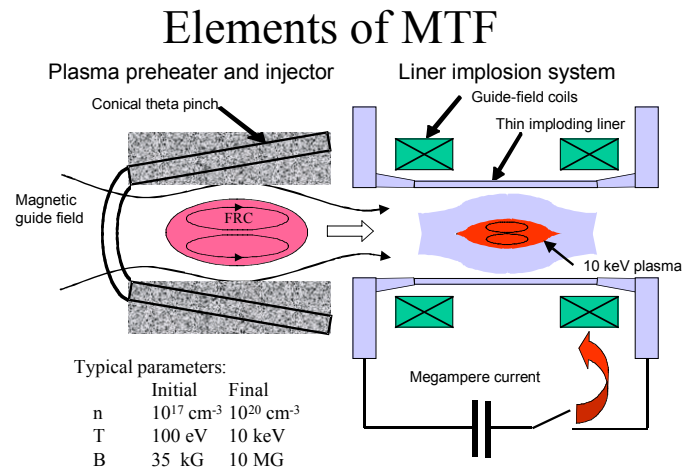

Current Research and Development (R&D)

R&D Goals and Challenges

The main PoP goal is to establish whether heating to thermonuclear temperature is possible with liner compression. Scientific issues include (1) achieving the relatively high initial density ($\sim 10^{17} \text{ cm}^{-3}$) and sufficient temperature ($\sim 300 \text{ eV}$) needed for a target plasma, (2) stability of liner and plasma during compression, and (3) wall-plasma interactions throughout the process. For practical generation of electricity, the major issue is cost of material that must be processed for each pulse (the "kopeck" problem). Low-cost refabrication of electrical leads or methods of stand-off power delivery are being studied.

Related R&D Activities

Research complements and depends upon ongoing compact torus research, pulsed-power liner implosion work, and development of inertial fusion energy (IFE) power-plant energy technology. Both inertial confinement fusion (ICF) and MTF involve containment of pulsed fusion energy (multi-megajoule to gigajoule) with plasma-facing liquid walls of fluorine-lithium-beryllium molten salts (Flibe) or lithium.

Recent Successes

In recent years liner implosion experiments have demonstrated the symmetry, kinetic energy, and velocity needed for MTF. Integrated plasma formation and liner-on-plasma experiments have not been done since the 1970s. Compact torus research in the 1980s and 1990s has developed improved methods for plasma formation and preheating.

Budget

FY 1998: \$115K; FY 1999: \$1M; and FY 2000 (needed): \$6.6M.

Anticipated Contributions Relative to Metrics

Metrics

- **Energy concepts**—The long-term application of MTF to energy production has not been examined as extensively as for conventional magnetic or inertial fusion, and metrics are less well defined. For pulsed systems like MTF and ICF, the product of gain and efficiency enters strongly into economics. MTF is expected to operate with smaller gain but higher efficiency than ICF, and the product will be an important metric for the research program. With MTF, yields in the gigajoule range would allow advantages at a lower repetition rate than conventional ICF. Several energy approaches are being studied. Pulsed compression with circulating liquid metal similar to the early LINUS concept is one approach. Low-cost refabrication of electrical leads that deliver power through a liquid blanket as proposed in the 1978 Conceptual Fast Liner Reactor Study is another. Stand-off delivery of power by efficient lasers, ion beams, or electron beams is a third. A completely different approach to power conversion might be possible if neutron energy were used to flash vaporize the blanket and the 1- to 2-eV vapor were then used for magnetohydrodynamic (MHD) generation of electricity.
- **Science**—The intermediate density regime, which differs by 5 to 6 orders of magnitude from both MTF and ICF, allows many tests of scientific understanding. New insights into the physics of FRCs should result from MTF compression experiments that seek kiloelectron-volt temperatures and much higher density but still work with similar values of dimensionless parameters, such as size relative to ion gyroradius compared with present and most previous FRC experiments. Bohmlike turbulence is observed in solar wind studies of an FRC-like field-reversed current sheath, and MTF is expected to work with a comparable level of turbulence. Generation of magnetic fields and magnetic reconnection at high temperature and high beta is expected in MTF experiments and is also seen in astrophysics. Improved understanding of wall-plasma interactions through theory, computational modeling, and experiment is a major goal for MTF. This understanding may have application to tokamak divertors, plasma processing, and radiative-condensation instabilities in $\beta \gg 1$ astrophysical plasma.

Near Term ≤ 5 years

A PoP test appears possible in less than 5 years if funding is made available. Assuming success with the PoP and an increased level of funding, a near break-even test could be done in about 2003–2005 using the Los Alamos ATLAS pulsed-power facility being constructed by DOE–DP. An interesting aspect to MTF is that university-scale experiments can fully test MTF targets, and the community-based MTF research program assumes a multi-institutional campaign of testing targets developed on small-scale experiments in the large-scale defense program facilities. Success in the laboratory would give strong incentive for expanded work on technologies needed for economic energy production.

Midterm ~ 20 years

From a development perspective, MTF can be viewed as a broad class of possibilities that are characterized by low cost and pulsed operation. Possible MTF embodiments range from FRC or spheromak target plasmas to a class of Z-pinch-like wall-confined plasmas as represented by the Russian MAGO configuration. Heating is possible with liner-driven implosions or stand-off laser-beam or particle-beam drivers with reduced power and intensity requirements compared with ICF. Development can proceed rapidly because the necessary scientific studies (including burning plasma physics) require no billion-dollar-class facilities.

Long Term >20 years

If MTF is successful, the development phase for fusion energy should be significantly accelerated, and the ultimate cost of electricity should be reduced in accord with reduced development costs.

Proponents' and Critics' Claims

Proponents are excited because MTF offers an affordable path to burning plasma experiments and an intriguing and generally unexplored possibility for practical fusion energy. In the restructured fusion program that emphasizes finding low-cost development paths for fusion, MTF is a logical new element. In addition, MTF strengthens the fusion portfolio because it represents a qualitatively different approach compared with conventional magnetic and ICF approaches. So far no physical limitation has been identified that precludes developing MTF as a practical fusion energy system, and several promising development paths have been identified.

Critics argue that pulsed systems like ICF and MTF are unlikely to meet the practical requirements for pulse repetition rate and cost per target, especially in the case of MTF if it involves replacement of liner hardware on every pulse. There are also technical concerns that high-Z liner material will mix rapidly with the relatively low-density fusion fuel, leading to unacceptably large radiation losses. Some have expressed concern that pulsed fusion approaches like MTF might lead to new types of nuclear weapons. However, scientists who analyzed this possibility say, “We see no immediate danger of a militarily attractive new type of weapon being developed from the current unclassified research programs on pure-fusion explosions.” [S. Jones, R. Kidder, and F. Von Hippel, *Physics Today*, September 1998, p. 57.]

Description

The boundary plasma is the interface between the hot core plasma and the material walls of the surrounding vacuum vessel. It constitutes a buffer zone that protects the walls from the hot plasma and shields the plasma core from impurities originating at the walls. Access to most of the improved plasma confinement modes has been achieved through the application of wall conditioning techniques as depicted in Fig. 1, which shows the effect of lithium wall conditioning on plasma performance in the Tokamak Fusion Test Reactor (TFTR). The so-called Supershot regime, depicted in this figure, is attained through reduction in hydrogen and carbon recycling from the first wall in TFTR. Inside the separatrix, the plasma processes involve transport phenomena, magnetohydrodynamic (MHD) effects, transition physics, and atomic physics. Between the separatrix and the wall, the scrape-off layer (SOL) is dominated by atomic physics and by perpendicular and parallel transport processes. The wall surface plays an important role in the recycling of hydrogen isotopes, determining plasma fueling and wall inventory (of tritium). Plasma-surface interactions lead to impurity generation and to wall erosion. Transport of particles and energy from the plasma core to the divertors or limiters is discussed separately.

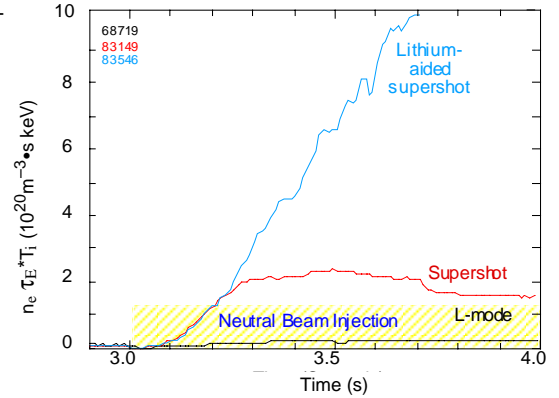

Fig. 1. Effect of wall conditioning in TFTR.

Status

Much progress has been made in characterizing the plasma boundary properties under a variety of conditions. Inside the separatrix, transport processes and their transition due to the formation of transport barriers (i.e., from L-mode to H-mode) have been characterized and correlated with changes in boundary plasma parameters. We are beginning to understand the interplay of parallel transport phenomena such as convection, conduction, and plasma flows in the SOL. A very prominent part in the plasma boundary program has been the development of wall conditioning methods to control plasma-surface interactions for optimum plasma performance. Experience with tritium retention in the walls of existing devices and the development of models such as REDEP and BBQ have increased our understanding of the underlying processes and highlighted the urgent need to develop efficient tritium removal methods. Transport processes in the boundary plasma have been characterized and described with complex models such as B2-EIRENE, DEGAS, or UEDGE. These models include the main working gas, hydrogen, as well as the prominent intrinsic or extrinsic impurities. However, currently there is no reliable physics-based model for the turbulent cross-field transport rates of heat and particles. Instead, these codes employ adjustable transport coefficients that are fitted to match experiments. Deliberately introduced impurities, such as neon, radiate predominantly in the plasma edge and are being used to create a stable radiating boundary for even distribution of exhaust power.

Current Research and Development (R&D)

R&D Goals and Challenges

- Establish detailed causal correlations between edge transport barriers and plasma edge parameters.
- Investigate stable radiating boundary plasmas as a mode of operation for fusion reactors.
- Provide an experimental database for further developing and coupling materials codes and plasma edge codes.
- Develop new wall conditioning techniques for high-performance plasmas applicable to long-pulse devices.
- Develop ways to avoid peaking of heat flux in space and time [edge-localized modes (ELMs) and disruptions] to permit the use of noncarbon materials, a necessary step for a tritium self-sufficient reactor.
- Develop empirical scaling relations between cross-field transport and local/global transport parameters.
- Apply knowledge base of plasma-surface interactions to materials processing and other nonfusion activities.

Related R&D Activities

- Strong international collaborations exist in all areas of boundary plasma physics. For example, wall conditioning techniques developed at TEXTOR are being applied and tested on most major machines.
- The Virtual Laboratory for Technology is developing high heat flux materials for plasma-facing components.

Recent Successes

- Stable radiating edge layers have been sustained with good confinement and low core impurity content.
- The role of neutrals in the plasma edge of the Doublet III-D (DIII-D) has been shown to play a role in the L-H transition.
- Tritium retention in beryllium has been shown to be much lower than expected at reactor conditions.

Anticipated Contributions Relative to Metrics

Metrics

The boundary plasma has to provide the buffer between core plasma and wall. In this capacity, it must fulfill a variety of tasks: (1) maintain strong gradients just inside the separatrix to support transport barriers, (2) maintain a stable radiating mantle with low core impurity concentrations, (3) shield the main plasma from wall impurities, (4) provide sufficient parallel transport for particle and power removal in the divertors or limiters, and (5) provide adequate perpendicular transport for sufficient radial power flux distribution. The plasma-surface interface has to be designed, with respect to materials choice and plasma parameters, for (1) minimum impurity production and erosion, (2) controllable wall recycling for plasma fueling and inventory control, and (3) minimum tritium inventory.

Near Term ≤ 5 years

It is known that wall conditions play an important role in establishing transport barriers and improving plasma performance, but the underlying physics phenomena that connect wall conditions with transport barrier formation are not well understood. Therefore, additional efforts are needed:

- Investigate the detailed atomic and molecular physics of hydrogen and impurities in the plasma boundary inside and outside the separatrix.
- Study techniques for establishing stable radiating boundary plasmas.
- Establish clear causal correlations between edge plasma parameters and transport barriers.
- Investigate the effects of impurities and neutrals on the formation of edge transport barriers.
- Develop and implement with dedicated machine time in-situ time-dependent diagnostics to provide the detailed database necessary for understanding plasma material interactions.

The database and modeling tools developed in the area of plasma-surface interactions should be adapted for broader use in nonfusion applications. Examples of nonfusion applications include materials processing, flat panel plasma display, and plasma spray coating.

Midterm ~ 20 years

- Build a new long-pulse machine with detailed wall/edge diagnostics dedicated to exploring long-pulse issues such as wall saturation, erosion, codeposition, and dust generation that are not significant in existing machines but pose challenges that will have to be solved for a high-duty-cycle fusion reactor.
- Develop predictive understanding of physical and chemical properties of mixed materials generated by plasma-surface interactions.
- Develop techniques to control wall erosion.
- Develop procedures for sustainable tritium inventory.

Long Term > 20 years

- Develop boundary plasma control techniques for minimum wall erosion, manageable tritium inventory, control of transport barrier properties, and good helium exhaust.
- Build on the scientific and engineering understanding gained in the previous 20 years to design and build an attractive fusion reactor that incorporates solutions to the long-standing issues of the first wall.

Proponents' and Critics' Claims

Proponents claim that the advances made in boundary plasma control over the past two decades have been a key contribution to the success of magnetic fusion energy research. Further accomplishments, needed for the full realization of magnetic confinement, can be predicted from reasonable extrapolation of past success.

Critics claim that the boundary plasma has traditionally been viewed in the realm of "kitchen physics," that is, governed by the application of purely empirical techniques that lack a firm scientific foundation. Extending high-performance discharges from the present second time scale to hours or days poses insuperable materials problems.

Description

Fusion energy is released by burning light elements using nuclear reactions that consume mass and release large amounts of energy in the form of extremely energetic charged particles or neutrons. The most reactive fusion fuel is a 50/50 mix of deuterium (D) and tritium (T) that requires fuel temperatures of $\sim 100,000,000^\circ\text{K}$ and the product of the fuel density n and energy confinement τ_E such that the Lawson product $n\tau_E > 2 \times 10^{20} \text{ m}^{-3} \text{ s}$. The energetic charged particles (3.5-MeV alphas for the D-T reaction) are confined by the magnetic field and deposit their energy in the plasma. Other reactions are possible, but higher temperatures and better confinement are required, ultimately resulting in much lower fusion power density for a given plasma pressure. In magnetic fusion, plasmas are heated to reaction conditions using external auxiliary power (Paux) and produce fusion power (Pfusion). The most fundamental metric is the fusion gain, $Q = P_{\text{fusion}}/P_{\text{aux}}$. Magnetic fusion reactors will require $Q \geq 25$ to be economically attractive. With Lawson product only $\sim 20\%$ higher, “ignition” is obtained, where the plasma is self-sustained purely by its alpha particle heating. The science of burning plasmas consists of (1) the physics of magnetic confinement in the “dimensionlessly large” reactor regime [transport, magnetohydrodynamic (MHD) stability and edge plasma parameters]; (2) the behavior of the plasma in the presence of energetic alpha particles (alpha confinement, induced instabilities, and energy transfer to the bulk plasma); (3) dynamic control of the self-heated plasma; and (4) power and particle exhaust, especially, removal of helium ash.

Status

Burning plasma science has been studied initially with deuterium plasmas that have provided understanding of plasma behavior near burning conditions and have allowed the first studies of energetic particle behavior at near burning plasma conditions. A series of experiments using 50/50 D-T fuel has been carried out on the Tokamak Fusion Test Reactor (TFTR) and the Joint European Torus (JET), which have produced fusion powers of 11 to 16 MW and Q values of 0.3 to 0.6 for durations of about 1 s. These experiments have confirmed many of the physics models for burning plasmas, but experiments are needed to study the science of a strongly burning plasma ($Q \geq 10$) for longer time durations.

Current Research and Development (R&D)**R&D Goals and Challenges**

- Obtain and explore controlled fusion burning plasmas.
- Investigate plasma confinement phenomena in the reactor regime of a large size relative to gyro radius, in an experiment that integrates confinement and stability in the core and edge plasma.
- Explore and understand the phenomena associated with reactor levels of fusion alpha-particles in a magnetically confined plasma, especially the instabilities that may be excited by their presence.
- Establish the practical feasibility of controlled burn in a self-heated burning plasma through passive and active influences on the overall power balance.
- Explore the compatibility of self-heating with the pressure and current profiles required for optimal stability, transport, and steady-state (long-pulse high-duty cycle) sustainment.
- Establish the practical feasibility of power and particle (especially helium) exhaust.

These goals reflect the progress that has been achieved in many topical areas during the past. However, no existing facility possesses sufficient confinement to take this next step to a burning plasma experiment that addresses these goals.

Related R&D Activities

- Inertial fusion burning plasma studies such as those proposed for the National Ignition Facility (NIF).
- Stellar dynamics (e.g., the marginal stability model for the sun).
- Fusion program research and technology in support of obtaining a burning plasma.

Recent Successes

- Theory, modeling, and experiments on energetic particle-induced instabilities.
- Theory, modeling, and experiments on transport and MHD (e.g., disruptions).
- Development of comprehensive diagnostics (J, Er, alphas, ...) for burning plasma experiments.
- Confirmation of the physics of a weakly burning D-T plasma and production of significant fusion power.

Budget

The next step to an experimental burning plasma requires a capital construction project at least of the magnitude of one of the major fusion facilities (TFTR, JET, JT-60) built in the 1970s. However, the U.S. fusion budget at its current level is insufficient to support such a project domestically. Refer to M-17. Burning Plasma Experimental Options for more details.

Anticipated Contributions Relative to Metrics

Metrics

- Science
 - Enter and diagnose the regime where alpha heating dominates the power balance and defines the plasma pressure profile $Q \geq 10$ and preferably $Q \rightarrow \infty$.
 - Determine the transport properties, MHD stability, and edge-plasma characteristics of a reactor-size plasma.
 - Demonstrate quantitative predictive understanding of alpha particle dynamics, both single particle and collective effects, in the strongly burning plasma regime.
 - Demonstrate global thermal stability at high Q .
 - Demonstrate high bootstrap-fraction burning plasma operation.
 - Demonstrate power exhaust and alpha ash removal for at least ten energy confinement times.
- Energy
 - Demonstrate scientific feasibility of high- Q D-T controlled fusion reactions using magnetic confinement.
- Technology
 - Integrate safe handling of tritium into a burning plasma environment.
 - Demonstrate fueling and heating technologies for a reactor-scale plasma.
 - Establish plasma-facing component technologies for reactors.
 - Demonstrate remote handling technologies.

Near Term ≤ 5 years

- Possibly further ($Q \sim 1$) experiments on JET briefly in 2002.
- No alpha-dominated experiments are possible using the existing magnetic fusion energy (MFE) facilities.
- Carry out design activities and related experimental investigations on prototypical facilities to establish optimal configurations and expectations for a next step burning plasma experiment.
- Develop the engineering basis for a next step burning plasma experiment.
- Develop a scientific consensus worldwide in support of the burning plasma physics mission.

Midterm ~ 5 to 20 years (2004 to 2019)

- Explore burning plasma physics on an alpha-heated magnetically confined plasma.
- Demonstrate efficient alpha energy transfer to bulk plasma with alphas providing at least 65% of heating power ($Q > 10$).
- Demonstrate sustained burn for at least five energy confinement times.
- Respond appropriately to a decision in ~ 2000 by the international participants on the construction of the International Thermonuclear Experimental Reactor (ITER).

Long Term > 20 years

- Demonstrate steady state burning plasma at $Q > 25$ and provide the burning plasma science basis for an MFE reactor.

Proponents' and Critics' Claims

Critics claim that present MFE concepts, especially the tokamak, do not project to reactor systems with economics competitive with natural gas, fossil fuels, and fission. High Q plasmas based on today's most advanced magnetic configuration cannot be controlled at advanced performance levels, and the plasma may constantly disrupt and result in a reactor concept with low reliability. The science of the final MFE reactor may be quite different from the concepts investigated during the last 50 years, and the burning plasma science developed in today's magnetic concepts may not be generic.

Proponents state that the leading MFE configurations (tokamak, stellarators and spherical torus) project a power plant cost of electricity within a factor of 2 of existing fission power plants if a high Q plasma can be sustained with high reliability. Tokamaks are sufficiently advanced that burning plasma physics can be accessed with a modest extension of existing science and facilities. Thus far, there appear to be no technical showstoppers; therefore, the burning plasma physics step can be taken with reasonable assurance. Burning plasma physics should first be demonstrated to establish scientific feasibility and to understand the scientific issues of a strongly burning plasma, many of which are generic to all MFE reactor concepts. Subsequently, the magnetic configuration can be optimized to develop an attractive MFE reactor with favorable economics and high reliability.

M-17. BURNING PLASMA EXPERIMENTAL OPTIONS

Description

The options for a next step burning plasma experiment are defined by the overall strategic pathways available for the development of magnetic fusion energy (MFE) as shown in Fig. 1. The one step to demonstration reactor (DEMO) would be undertaken by a single large facility, such as the International Thermonuclear Experimental Reactor (ITER), with multiple missions of developing and integrating burning plasma physics, long-pulse physics and technology, and fusion technologies. The enhanced concept innovation pathway would delay burning plasma experiments to emphasize first, experimentation on, for example, stellarators, spherical tori, reversed field pinches, spheromaks, and multipoles. However, none of these configurations could be ready for a burning plasma test at $Q \geq 10$ in less than a decade. The modular pathway employs multiple facilities each focused on resolving a key MFE issue at conditions approaching those expected in an MFE system. The modular pathway addresses the key technical issues, high-Q burning plasmas and steady-state operation, separately.

Status

The burning plasma issues for MFE are discussed in M-16. The status of the leading magnetic configurations to address MFE burning plasma issues is given in terms of the extrapolation required from parameters achieved in laboratory experiments to those required in that concept's reactor assessment by the Advanced Reactor Innovation and Evaluation Studies (ARIES) (Table 1).

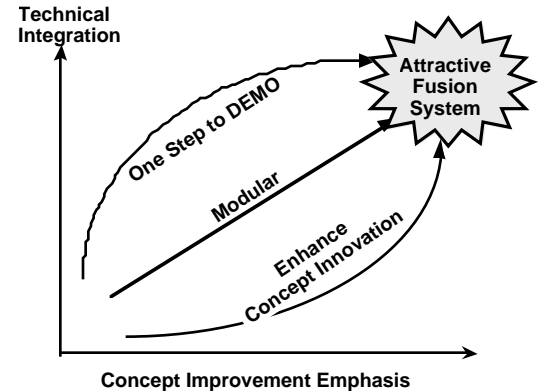

Fig. 1. Pathways for the Development of Magnetic Fusion

Table 1. Required extrapolation

	Tokamak	Stellarator	Spherical torus	ARIES
$n\tau_E T_i$	10	1,000	100,000	1
Plasma pressure	3	100	>100	1
Neutron wall load (MW/m^{-2})	50	>1,000	>1,000	1
Duty cycle	50	>1,000	>10,000	1

Only the tokamak is sufficiently advanced to address the burning plasma physics issues of MFE within the next decade. The crucial issues of understanding the science of plasma transport and magnetohydrodynamic (MHD) stability in advanced configurations where the profiles are defined by alpha heating can be studied thoroughly in the tokamak configuration, and this knowledge can be used to understand and predict burning plasma physics phenomena in other magnetic configurations. A next step MFE experiment capable of achieving $Q \geq 10$ in deuterium-tritium (D-T) plasmas would serve both as proof of performance and as a facility to explore, understand, and optimize burning plasmas for MFE in parallel with the National Ignition Facility (NIF)/LMJ experiments for IFE.

Current Research and Development (R&D)

R&D Goals and Challenges

Previous design studies of next step burning plasma experiments (TFCX, CIT, BPX, and ITER) have all produced technically credible designs but have not garnered the required scientific and financial support to proceed with construction. The challenge is to develop a design proposal with a more focused mission that will address the critical burning plasma issues within a constrained budget profile.

Related R&D Activities

The base theory, modeling, and confinement program will interact closely with the burning plasma experiment. Enabling technology development in plasma heating, current drive, and fueling (pellet injection) will be needed for the burning plasma experiment. Fusion technology development (especially tritium handling and remote handling) will be integrated with the experiment.

IFE burning plasma experiments on NIF/LMJ will be complementary to the MFE burning plasma experiment(s).

Recent Successes

Recent experiments and the ITER design study have produced a well-documented physics basis for analyzing burning plasma performance.

Budget

IGNITOR is viewed as an Italian project with potential European Community (EC) support. ITER-RC is viewed as a Japanese, European, and Russian project with potential U.S. support. FIRE is viewed as a U.S. project with potential international support (Table 2). The construction budgets for the representative next-step options are estimated in Table 3.

Anticipated Contributions Relative to Metrics

Metrics

Table 2. Extrapolation required

	IGNITOR	FIRE	ITER-RC	ARIES
$n\tau_E T_i$	~1	~1.5	<1.5	1
Plasma pressure	~0.6	~0.8	2	1
Neutron wall load (MW/m ²)	~1	~1	8	1
Duty cycle	>1000	>1000	~10	1

In the modular pathway the duty cycle metric will be addressed in a separate steady-state advanced toroidal facility.

Near Term ≤5 years

- Comprehensive technical assessment of all approaches to fusion and identification of key metrics (1999).
- Performance optimization and cost reduction, design activities with supporting physics, and technology R&D.
- Proposal ready for technical review and decision by end of 2000 in concert with international decision on ITER.

Several representative options for a next step burning plasma experiment in MFE have been identified during the next step options study that followed the Madison Forum with parameters in the ranges illustrated in Table 3.

Table 3. Options with parameters

	R(m)	B(T)	Coils	Ip (MA)	Gain	Pfusion (MW)	Exhaust	Burn time (s)	Cost (\$M)
IGNITOR	1.32	13	30°K Cu	12	>10	~200	Limiter	5	<500
FIRE	~2.0	~10	70°K BeCu	~7	~10	~200	DND	≥10	<1000
ITER-RC	6.2	5.5	NbSn S/C	13	10	~500	S-DND	≥400	<6000

ITER-Reduced Cost (RC) is very similar to the ITER EDA with the same overall program objective—to establish the scientific and technological feasibility of magnetic fusion—but with slightly reduced size and performance to reduce the construction cost by 50%. ITER-RC would have superconducting coils capable of allowing up to steady state under driven plasma conditions. IGNITOR is a very compact high-field moderately shaped tokamak with cryogenically cooled copper coils. The plasma is heated to high Q by ohmic and ion cyclotron range of frequencies (ICRF), and the plasma power and particles are exhausted using the first wall as a limiter. The Fusion Ignition Research Experiment (FIRE) is based on previous U.S. compact copper-conductor burning plasma experiment designs (CIT, BPX, BPX-AT), but responds to recent tokamak physics developments. FIRE is a compact high-field tokamak similar to IGNITOR but with higher triangularity and a double-null closed-divertor configuration.

Midterm ~20 years

- Initiate construction of next step burning plasma experiment by 2002 with first operation by 2009 with high-Q D-T plasmas by 2012 (if compact high field) or first plasma by 2012 and high-Q D-T by 2016 (if ITER-RC).
- Make a major programmatic decision in 2015 to 2020 time frame on the selection of potential concept(s) for further development as an Advanced Integrated Experimental Reactor or for burning plasma tests of additional concepts.

Long Term >20 years

If successful, the key burning plasma issues would be addressed and resolved by 2020.

Proponents' and Critics' Claims

The tokamak is favored by a vast majority of the world MFE programs for a next step burning plasma experiment; the issue is whether the tokamak will lead directly to an economical reactor. The JA, EC, and Russian Federation fusion programs favor the one step to DEMO strategy, and it has been central to their official program plans. A majority of the U.S. fusion community (e.g., the Madison Forum) favor the modular pathway, which was the MFE pathway prior to the ITER initiative and is similar to the IFE pathway. The enhanced concept innovation pathway would delay initiation of a burning plasma experiment to develop the optimum magnetic configuration at small size and cost prior to large-scale testing. This approach will extend the time scale and possibly the cost if difficulties arise at the proof of performance and burning plasma phase with dominant alpha heating.

Critics claim that the cost of ITER and even ITER-RC is too high, indicating that the tokamak will not be a cost-effective power plant. They further dispute the general applicability of burning plasma science from the tokamak, particularly to the more self-organized plasma systems.

Description

Integrated Fusion Science and Engineering Technology Research integrates the physics of burning plasmas with engineering technologies needed to design a commercial demonstration fusion power plant, often called the demonstration reactor (DEMO). Integrating research in a single facility is often called one-step-to-DEMO strategy. This approach, with international collaboration, is the fastest and least expensive route to a commercial fusion power plant; it is also the most reliable because the physics data returned will require little extrapolation to DEMO. Several variations are now under active study, ranging from the Reduced Technical Objectives/Reduced Cost International Thermonuclear Experimental Reactor (ITER-RC), to the less capable JT-60 Super Upgrade. These devices all support an operational deuterium-tritium (D-T) burning capability. Their superconducting magnets are essential to developing the plasma physics of burning steady-state tokamaks and will assure that investments in magnet technology will benefit DEMO. A second common feature, shown in Fig. 1, is a poloidal field coil set outside the toroidal field magnets with a segmented central solenoid. This coil arrangement offers flexibility consistent with the tokamak reactor concept and can support both single-null and double-null divertor operation as well as Advanced Tokamak (AT) research. Much of the technology data, such as high-heat-flux components, magnet fabrication, tritium breeding, neutral beam and gyrotron auxiliary power systems, as well as erosion of plasma-facing components, will be generic to all toroidal magnetic fusion energy approaches.

The broad international tokamak database serves as the baseline design for ITER-RC. This will project, with margin, to nominal D-T burning with $Q \geq 10$ and will permit investigations of fusion science issues such as β - and density-limits and their control as well as provide helium exhaust data and neutrons for technology assessments. The flexibility inherent in the PF system, the fueling system, and the auxiliary heating will support operation in advanced modes now foreseen as reactor compatible and provide AT design data for DEMO. With contemporary tokamak devices, it is impossible to simultaneously achieve reactor-like core plasmas and reactor-like edge plasmas. Thus, in any tokamak strategy, a ITER-RC class device is required to obtain the robustly reliable data needed for a steady-state AT with a D-T energy source to qualify as the design basis for DEMO/Advanced Reactor Innovation and Evaluation Studies (ARIES)-RS.

Status

The July 1998 ITER Final Design Report (FDR) established the engineering feasibility of a ITER-RC-class facility with detailed, disruption-tolerant engineering solutions for all design elements: first wall, divertor, magnets, poloidal field control, and tritium inventory. The engineering design is supported by \$800M of international engineering research and development (R&D) over 6 years with prototype testing. Key successes of the ITER/engineering design activity (EDA) physics program were to establish common, scaleable physics and simulation codes for the critical physical processes: divertors, disruptions, β -limits, power thresholds, and confinement scaling. A 400-page issue of *Nuclear Fusion* documenting the physics basis for both ITER/FDR and ITER-RC will appear in June 1999. Now, an ITER-RC design program, incorporating staged construction and operation to level cash flow, is being developed by the Three-Party Joint Central Team. Cost reductions (~50%) are achieved by ~50% reductions in the fusion power, inductive pulse length, and plasma volume. The new designs have higher triangularity plasma shapes, achieve $Q \geq 10$ with conventional ELMy H-mode physics, and are capable of full ignition with AT operation.

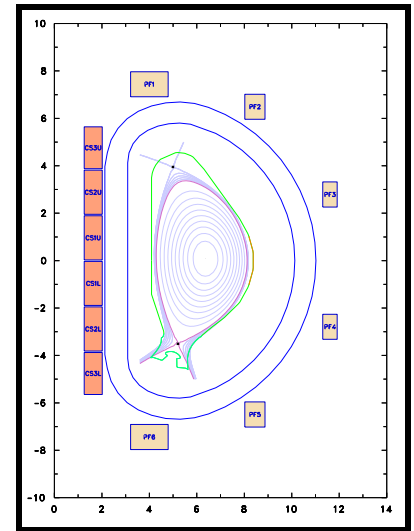

Fig. 1. A candidate ITER-RC design with AT capabilities.

Current Research and Development (R&D)

R&D Goals and Challenges

Demonstration of self-consistent profiles of α -heating, pressure, and bootstrap/driven current density as well as active control of $n = 1$ magnetohydrodynamic (MHD) modes are seen as crucial for steady-state operations at reactor β -values. For ELMy H-modes, increases in long-pulse β_N -values and operation at densities above the Greenwald value will increase the tokamak fusion power. Neo-classical tearing mode control by electron-cyclotron current drive and inside pellet launch fueling are respective proposed control techniques.

Anticipated Contributions Relative to Metrics

Energy Concept Metrics

The ITER-RC approach fulfills reactor-level metrics and also serves as a flexible test bed to improve β , density, reliability, fusion power, and wall-loading metrics, thus optimizing both the standard tokamak and ARIES-RS-like AT approaches to fusion power. Fusion power exceeding 500 MW for durations exceeding 500 s will enable nuclear testing.

Science Metrics

The tokamak science established by ITER-RC experiments will provide reactor-scale physics data not accessible to present machines. More generally, tokamak physics played a major motivating role in the development of the science of magnetized plasmas, which underlies all toroidal fusion concepts, as well as space, solar, and astrophysical plasma dynamics. Interdisciplinary examples include current sheets in reconnection and particle energization by Alfvén waves in space and the galaxy. The science concepts are shared, but each field develops its own simulation codes and facilities. Computationally, tokamaks will remain the principal quantitative comparison between five-dimensional turbulence simulation codes and experiment. Tokamak MHD codes will be at the frontiers of simulating current sheets and other examples of spatial intermittency.

Nonfusion Applications

ITER/EDA technology development has already produced state-of-the-art advances. Model test coils will make available large-volume, high-field test facilities for superconducting magnet technology. High heat flux components are important to many high-temperature processes. Gyrotrons have applications in plasma and materials processing, and potentially in radars.

Near Term ≤ 5 years

Already the ITER/EDA project, through physics expert groups, has been very effective at determining the key areas where physics research will define the design basis and requirements for a reactor-scale facility. This has identified conceptually new processes such as the role of recombination in divertors. But much remains to be done, and the discipline associated with a design project is needed to assure that nominal performance requirements are met and flexibility is retained.

Midterm ~ 20 years

This time frame will see operation of the ITER-RC facility and attainment of reliable fusion burn at the 500–1000 MW level over pulses of at least 500-s duration. The case for the reality of a fusion energy option will be made! Experimental fusion physics will enter reactor-scale experiments where the balance between different physical processes will differ from that of present experiments, leading to original tokamak physics data. Reactor blanket technology demonstrations will benefit from the neutron fluxes with initial blanket testing.

Long Term ≥ 20 years

The operational data acquired from ITER-RC in this period will form the basis of reactor utilization of advanced and/or steady-state tokamak operations with internal transport barriers. The required robust demonstrations for DEMO will be carried out by staged upgrades of the ITER-RC facility, based on reactor-scale data from its initial operations. Tritium breeding and other blanket technologies will be tested at moderate neutron fluences in test modules that fit into ITER-RC ports. Within 30 years, design of a DEMO will be nearly complete, and fusion power will be at the threshold of commercial realization.

Proponents' and Critics' Claims

Proponents claim that the ITER-RC approach employs a single facility for the necessary integrated physics and technology investigations at a minimum integrated cost. Since tokamak science at the reactor scale differs from that of present devices, ITER-RC will provide the relevant science basis for fusion energy. ITER-RC is no higher risk than modular approaches because all the technological goals must be met in any event. It further provides for reactor-scale development of advanced and steady-state burning plasma scenarios with as much flexibility as a tokamak can implement. At the present time, it is the only next-step tokamak for which international collaboration on construction can be foreseen and can lead to a commercial fusion power by ~ 2050 . A large advantage is derived by international cost sharing.

Critics claim that the ITER-RC facility cost places it out of reach for an energy technology demonstration. Moreover, ITER-RC specializes to the tokamak concept too early in the development of fusion energy; researchers should wait for the possible development of an alternative approach before moving to reactor-scale research. Science carried out in present tokamak facilities may permit a more judicious and optimized choice of reactor configuration.

M-19. VOLUMETRIC NEUTRON SOURCE

Description

- A Volumetric Neutron Source (VNS) is a deuterium-tritium (D-T) plasma-based facility that simulates the fusion environment and produces neutrons at a neutron wall load ($\sim 1 \text{ MW/m}^2$) and on a surface area ($\sim 10 \text{ m}^2$) sufficient to test in-vessel components: first wall, blanket, divertor, and vacuum vessel. The facility is designed so that the in-vessel components of the basic device are also part of the tests, especially for identifying failure modes, obtaining data on failure rates, testing remote maintenance, and determining shutdown times required to recover from failures.
- The D-T plasma is highly driven ($Q \sim 1$) and operated at steady state or long pulse.
- Several designs have been proposed including high aspect ratio tokamak, spherical torus (ST), and mirrors. In general, they have resistive copper magnets and a fusion power $< 150 \text{ MW}$ to minimize cost and tritium consumption (in some options, the facility breeds its own tritium).
- The purpose of tests in VNS are (1) to examine experimentally the scientific and engineering feasibility and attractiveness issues for various design and material system options for the first wall/blanket/divertor/vacuum vessel (e.g., solid and liquid walls); (2) to obtain critical data on basic phenomena and performance of in-vessel components concerning power and particle extraction, tritium self-sufficiency, failure modes and rates, maintainability, and other key issues; (3) to advance the engineering sciences necessary to conduct powerful D-T plasma physics experiments; and (4) to provide the engineering science knowledge base for the in-vessel system, which is a necessary element in the fusion program mission to identify an attractive fusion product.

Status

- The VENUS study at the University of California—Los Angeles (UCLA) (1994) and the International Energy Agency (IEA) study on HVPNS (1995) have made progress in defining the major requirements on VNS parameters and design features [see M. Abdou et al., *Fusion Technology*, **29** (1996)]. These include (1) neutron wall load $\sim 1 \text{ MW/m}^2$; (2) total test area at the first wall $\sim 10 \text{ m}^2$; (3) steady-state or long-pulse plasma operation; (4) configuration, remote maintenance, and other design features to emphasize the reliability of the basic device and rapid replacement of device components and test articles; (5) device availability $> 25\%$; (6) cumulative fluence (in sequential test articles) $\geq 6 \text{ MW year/m}^2$; and (7) fusion power $< 150 \text{ MW}$.
- Two Small Business Innovation Research (SBIR) studies [e.g., E. T. Cheng et al., “Progress of the ST-VNS Study,” *Fusion Technology*, in press] and other studies [e.g., Ho and Abdou, *Fusion Eng. & Design*, **31** (1996)] have identified two classes of possible VNS facilities. One is based on high A (~ 3.5), and the other is based on ST. Both satisfy the VNS requirements and are cost-effective. Some researchers in Japan and Russia proposed mirror-based facilities.

Current Research & Development (R&D)

R&D Goals and Challenges

- Identify the best design option for VNS that (1) is cost-effective, (2) can meet the testing requirements, and (3) requires modest extrapolation of current database.
- Perform the physics and engineering R&D necessary to build VNS by ~ 2015 – 2020 . Establish the physics and engineering bases for steady-state/long-pulse-driven ($Q \sim 1$) D-T plasma operation with high device availability ($\sim 25\%$) and rapid insertion and removal of test articles.
- Establish close interaction and coordination between the physics and technology community.
- Develop international framework for collaboration on VNS.

Related R&D Activities

- The National Spherical Torus (NSTX) program for establishing the physics database for ST plasmas.
- SBIR projects on design of VNS.
- Considerable experience relevant to VNS gained from the International Thermonuclear Experimental Reactor (ITER) Test Program.
- Several international workshops and an IEA study on VNS.

Recent Success

- Results of the IEA study on High Volume Plasma-Based Neutron Source have shown clear consensus among international technology experts of the critical need for VNS and have identified the mission for and major requirements on VNS.
- SBIR and other studies have identified attractive and cost-effective options for VNS.

Budget

Currently, only one company is funded through the SBIR program at \$750K for 3 years. Some activities are being carried out on VNS-ST under the NSTX program.

Anticipated Contributions Relative to Metrics

Metrics

- Neutron wall loading $\sim 1\text{--}2\text{ MW/m}^2$.
- Steady-state D-T plasma operation or long burn length ($>1000\text{ s}$) with a duty cycle $>80\%$.
- Cumulative neutron fluence in successive test article $\geq 6\text{ MW year/m}^2$.
- Total test area at the first wall $\geq 10\text{ m}^2$, a minimum test area per test article of $\sim 0.36\text{ m}^2$.
- Device availability $>25\%$.
- Capability for continuous operation during test campaigns of $>1\text{--}2\text{ weeks}$.
- Magnetic field in the test region $>2\text{ T}$.

Other metrics related to cost-effectiveness and experimental flexibility include fusion power $<150\text{ MW}$; configuration, remote maintenance, and other features that emphasize device reliability and rapid insertion and replacement (days) of test articles; relatively low power consumption (for normal copper coils, current drive) $<400\text{ MW}$; and safe operation.

Near Term $\leq 5\text{ years}$

- Conceptual design of a VNS to meet its mission requirements at reasonably low cost, modest risk, and minimum extrapolation of physics and technology database.
- Physics database from the NSTX program for VNS-ST and from other world facilities for standard aspect ratio tokamaks.
- Engineering interface solutions for test article integration including instrumentation and remote maintenance. Examples of conceptual designs of test articles based on engineering scaling rules.

Midterm $\sim 20\text{ years}$

- Progress in physics database for VNS (plasma-driven) facility.
- Progress in establishing the engineering database for VNS.
- Database from nonfusion facilities for first wall/blanket/divertor options to be tested on VNS.
- Engineering design of VNS (most likely with international collaboration).
- Construction of VNS (around the year 2015?).

Long Term $>20\text{ years}$

- Use VNS to obtain database on first wall/blanket/shield, remote maintenance, and other systems.
- Identify the most attractive options of in-vessel components for an attractive and competitive fusion product.

Proponents' and Critics' Claims

Proponents see a VNS as the most practical and cost-effective option for obtaining critical data on in-vessel components and material systems. Proponents see VNS as a critical element in establishing the engineering feasibility of fusion systems (especially for key issues such as heat and particle removal capability, tritium self-sufficiency, failure rates and modes, maintainability, and safety and environmental features). Proponents also claim that conducting (nuclear technology) testing and plasma ignition in two separate facilities is the most cost-effective pathway because nuclear testing requires small power but high fluence while ignition requires large power and low fluence.

Critics claim that combining the mission of VNS with plasma ignition in a single facility such as ITER is a more desirable approach because it focuses world attention on one facility and provides full integration of all systems. [Proponents of VNS counter that VNS will still be needed prior to a demonstration reactor (DEMO) even if ITER is built. The IEA study on VNS calculates that the maximum availability achievable in DEMO is $\sim 4\%$ with the ITER-alone scenario; testing in-vessel components in VNS will allow the DEMO to reach its availability goal of 50% .] Critics also voice concern that VNS cannot achieve 25% availability and $6\text{ MW}\cdot\text{year/m}^2$ fluence because of the lack of an adequate engineering database. [Proponents of VNS counter that generating the engineering database is part of the mission of VNS. They say that engineering tests are expensive, complex, and time-consuming and that the only cost-effective approach is to perform these engineering tests on a small device (driven plasma $Q \sim 1$, small fusion power).] Proponents also argue that what matters is the cumulative fluence experience in sequential test articles, not only the fluence on a given test article. Proponents also ask that if building the small-size, small-power VNS with availability of 25% is high risk because of lack of engineering database, how can we assume that the much larger (20 times the volume), more expensive (10 times higher cost), and much more demanding (50% availability) DEMO could be built without VNS?

Description

All important advanced fusion fuels produce their energy mainly as charged particles, in contrast to the 80% neutron power fraction produced by deuterium-tritium (D-T) fuel and ~50% produced by deuterium-deuterium (D-D) fuel. Anticipated engineering, safety, and environmental advantages of reduced neutron production motivate advanced-fuel research, despite greater physics obstacles compared to D-T (see following page). The two advanced fuels generally considered most important are D-³He (1–5% of fusion power in neutrons from D-D reactions) and p-¹¹B (no neutrons). Although p-¹¹B and ³He-³He produce no neutrons, calculations indicate that Maxwellian (thermal) plasmas will produce bremsstrahlung radiation power less than or equal to fusion power. Burning of p-¹¹B, therefore, would require non-Maxwellian fusion concepts (e.g., inertial-electrostatic confinement or colliding-beam fusion) or very low charged-particle transport and other radiation losses. Fusion gain, even under these circumstances, is projected to be modest, requiring a large recirculating power fraction.

Status

Researchers have pursued advanced fuels since the earliest days of fusion energy because D-T fusion carries the liabilities of high radiation damage, large induced radioactivity and afterheat, a large radioactive waste volume, complex tritium-breeding blankets, and extensive tritium handling. Conceptual design studies show the following:

- Radiation damage in advanced-fuel power plant structures would be sufficiently low for them to be full-lifetime components, whereas tritium-breeding blankets and part of the shield must be replaced every few years for D-T.
- Induced radioactivity in advanced-fuel power plants would be sufficiently low for the waste to qualify at worst as low-level, essentially similar to hospital radioactive waste, and for the power plant to qualify as inherently safe (no possibility of significant radioactivity release or a meltdown).
- Fueling and exhaust handling systems in advanced-fuel power plants should be relatively simple in comparison to the complex safety and processing equipment required for the large D-T power plant tritium throughput.
- Surface heat fluxes on D-³He first walls are manageable, particularly in geometries where the charged particle transport losses flow along magnetic fields outside the fusion core into a separate chamber.
- Sufficient ³He has been identified on earth to conduct a D-³He fusion research program up to and including the first 1000-MW(e) power plant.
- Advanced fuels such as p, D, and ¹¹B are plentiful on earth, but large-scale deployment of D-³He power plants would require use of the large ³He resource (~10⁹ kg) on the lunar surface.

Current Research & Development (R&D)**R&D Goals and Challenges**

- Develop fusion concepts for advanced fuels. Several presently funded innovative magnetic fusion concepts would satisfy this challenge for D-³He, while p-¹¹B would require a non-Maxwellian plasma approach.
- Quantify the safety, environmental, and economic attributes of advanced-fuel power plants. The importance of energy for the global environment and marketplace makes careful evaluation of all fusion options necessary.
- Demonstrate the feasibility of lunar ³He acquisition or terrestrial breeding. The Apollo program developed much of the required rocket technology 30-years ago, but the use of terrestrial mining technology and its reliability on the moon remain unproven. Attractive ³He breeding methods have not yet been identified.

Related R&D Activities

- A very small experimental and theoretical research program exists for the high-β (plasma pressure/magnetic field pressure) configurations best suited to burning advanced fusion fuels.
- Lunar ³He geologic, economic, environmental, and legal characteristics have been analyzed and found to be favorable, although this activity is presently unfunded and dormant.
- Direct conversion of charged particle energy to electricity at high efficiency (>60%) was shown at Lawrence Livermore National Laboratory in the 1970s.

Recent Successes

- Innovative concept research resurfaced several years ago after a decade that virtually eliminated all advanced configurations. The reinvigorated program has been producing encouraging theoretical results for the high-β concepts of primary interest for advanced fuels. Innovative concept experiments presently are coming on-line.
- The Joint European Torus (JET) produced 200 kW of D-³He fusion power in 1993.
- Fusion power plant conceptual design analyses support the attractiveness of advanced-fuel fusion. Although the funding level of these studies is low, they give qualitatively encouraging results.
- National Aeronautics and Space Administration (NASA), NASDA (Japan), and other space agencies are seriously assessing the near-term return of humans to the moon, including the assessment of ³He resources and mining technology.

Budget

The present worldwide budget for advanced-fuel research is less than \$1M.

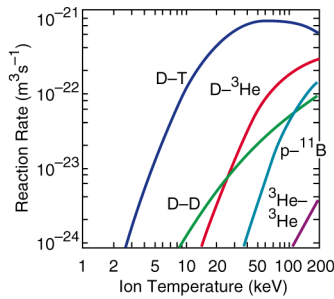

**Reaction rates
(Maxwellian plasmas)**

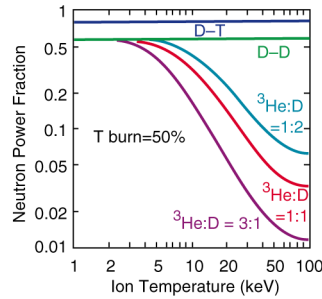

**Neutron power production
(Maxwellian plasmas)**

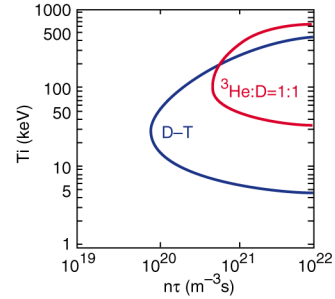

**Ignition temperature and
confinement requirements**

Anticipated Contributions Relative to Metrics

Metrics

- β . Innovative confinement concepts must demonstrate sufficiently high values (>0.2) of this ratio of plasma pressure to magnetic-field pressure for advanced-fuel operation. The β value is fundamental to achieving high fusion power density, which strongly relates to cost and scales as $\beta^2 B^4$, where $B \equiv$ magnetic field magnitude.
- $n\tau$. Sufficient values ($>10^{21} \text{ m}^{-3} \text{ s}$) of this “confinement parameter,” the product of plasma fuel-ion density and energy confinement time, must be demonstrated for plasma charged-particle energy losses to be manageable.
- Projected cost of electricity (COE). New power plant concepts must achieve competitive COE values to break into the anticipated future energy marketplace. Detailed conceptual design analyses for the high- β innovative concepts remain to be performed at the level required for confident COE projections.

Near Term <5 years

- Demonstration of proof-of-principle (PoP) for a high- β innovative concept would be a major step along the path of advanced-fuel fusion.
- Detailed conceptual designs could lay a firmer foundation for the anticipated benefits and challenges of coupling advanced fuels with innovative confinement concepts.

Midterm ~20 years

- PoP D- ^3He operation in an innovative confinement concept appears likely given the pace of concept progress.
- A suitable non-Maxwellian fusion concept for third-generation fuels, such as p- ^{11}B , might reach the PoP stage.
- Burning D- ^3He in an integrated test facility could be accomplished with a concerted effort.
- Demonstration of the feasibility of returning ^3He economically from the moon to earth will be necessary for D- ^3He power plants. Because of the modularity of the mining process, the required scale should be modest.

Long Term >20 years

- Because advanced fuels substantially relax engineering constraints, a physics PoP demonstration during the midterm research phase could lead to operating commercial power plants in this time frame.
- Solar system exploration and development will be in progress, and lunar operations for science and ^3He acquisition will most likely have begun.

Proponents' and Critics' Claims

Proponents claim that (1) the decades of testing required for developing reliable, low-activation materials will keep D-T fusion from entering the marketplace on any relevant time scale; (2) D- ^3He plasmas can have higher fusion power densities than D-T plasmas, because neutron damage limits D-T neutron wall loads more than surface heat loads limit D- ^3He plasmas; and (3) lunar ^3He acquisition requires essentially developed technology.

Critics claim that (1) advanced materials can mitigate the D-T neutron damage, activation, and afterheat problems; (2) D-T power plants can also make use of progress in β or $n\tau$ by the innovative concepts; and (3) the procurement of ^3He from the Moon is too speculative.

C.3 INERTIAL FUSION ENERGY (IFE)

An inertial fusion energy (IFE) power plant, Fig. C.4, would consist of four major components including a target factory to produce about 10^8 low-cost targets per year, a driver to heat and compress the targets to ignition, a fusion chamber to recover the fusion energy pulses from the targets, and the steam plant to convert fusion heat into electricity. These IFE elements have some unique potential benefits for fusion energy and some unique challenges.

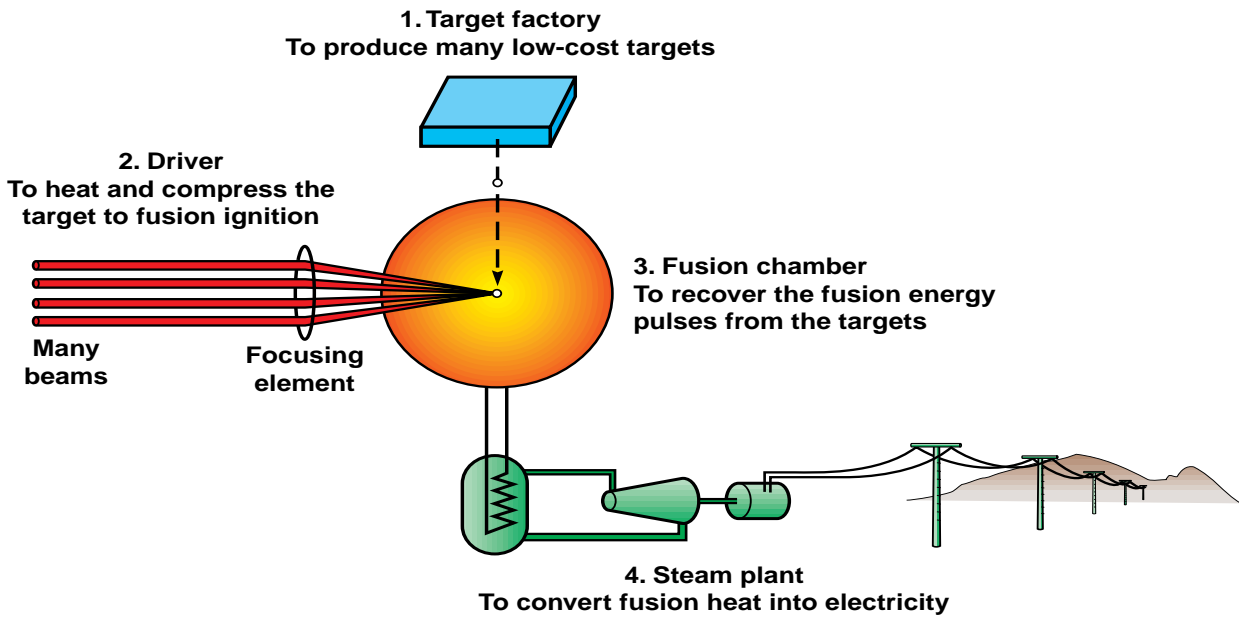

Fig. C.4. Schematic of an IFE power plant.

- The characteristics of the National Ignition Facility and potential inertial configurations and drivers are discussed in I-1 through I-9.
- Target matters are discussed in I-10.
- The final optics are discussed in I-11.
- Other IFE technologies are discussed in I-12 and T-15 through T-19.
- Technologies common to MFE and IFE are discussed in T-8 through T-12.

Drivers for IFE must achieve an efficiency that depends on the target gain. Central to the economics of any IFE power plant is the fusion cycle gain. The fusion cycle gain is the product of the driver efficiency η (the ratio of the energy delivered to the target and the energy supplied to the driver), the target gain G (the ratio of the thermonuclear yield and the driver energy), the nuclear energy multiplier M (the energy change due to neutron reactions, principally in the lithium-bearing blanket used to produce tritium), and the thermal-to-electric energy conversion efficiency ϵ . In any inertial fusion power plant, the net electricity P_n is related to the gross electricity P_g through the power balance equation:

$$P_n = P_g - P_a - P_d = P_g (1 - f_a - 1/\eta GM\epsilon) ,$$

where P_a is the power used for auxiliary equipment, and $f_a = P_a/P_g$ is typically a few percent of the gross electricity. P_d is the driver power, and the driver's recirculating power fraction P_d/P_g is the reciprocal of the fusion cycle gain $\eta GM\epsilon$. If the recirculating power fraction becomes large, the cost of electricity (COE) escalates rapidly.

The nuclear energy multiplier M is typically 1.05 to 1.15, and the conversion efficiency ϵ is typically 0.35 to 0.50. If the product $\eta G = 7$ for example, the recirculating power would range from 25% to near 40%. Lasers currently being developed have projected efficiencies of 6–10%, while heavy ion accelerators have projected efficiencies of 25–40%. Hence laser drivers will require targets with higher gain than ion beam drivers for a given recirculating power fraction or driver cost.

The COE is given by:

$$\text{COE} = \frac{dC/dt}{P_n A} \approx \frac{dC/dt}{P_g(1 - f_a - \frac{1}{\eta G M \epsilon})A} .$$

The factor “A” is the plant availability, and dC/dt includes the operating and maintenance cost as well as the capital cost per unit time. For fusion power plant designs that are capital intensive, typically 80% or more of the COE is the capital cost, which includes cost for the driver, reactor plant equipment, and balance of plant. In the various IFE designs that have been carried out, the driver costs range from less than 30% to almost 50% of the capital cost. There is a driver size and target gain combination that minimizes the COE. Target gain typically increases for larger driver energy resulting in a higher fusion cycle gain and lower recirculating power. However, the larger driver costs more and increases the capital and operating costs. This results in an optimal driver size and recirculating power that varies with the driver type. Lower cost drivers can afford a larger recirculating power for the same COE.

In addition to efficiency, IFE drivers must have adequate repetition rate and durability. In the typical IFE chamber, targets would be injected 5–10 times per second. Over the 30-year life of a fusion plant, the driver would need to produce nearly 10^{10} pulses. A driver must be able to deliver a sufficiently high fraction of this number of pulses between maintenance cycles so that plant availability remains high.

Two principal approaches are used to generate the energy flux and pressure required to drive an ICF implosion (see Fig. C.5).

In the direct-drive approach, the driver beams are aimed directly at the target, which in this case consists of just the fusion capsule. The beam energy is absorbed by electrons in the target’s outer corona. With short wavelength lasers, absorption can exceed 80%. Electrons transport that energy to the denser shell material to drive the ablation and the resulting implosion. The most highly developed direct-drive targets use laser drivers although direct-drive targets using ion beams may also be feasible.

Concepts utilizing z-pinch driven X-ray sources may also prove to be a viable approach to igniting ICF fuel capsules. **In the indirect-drive approach**, the driver energy is absorbed and converted to X rays by material inside the hohlraum that surrounds the fusion capsule. The beam and hohlraum geometry are determined by the requirement for X-ray flux uniformity on the capsule. The most highly developed indirect-drive target designs use laser or ion beam drivers.

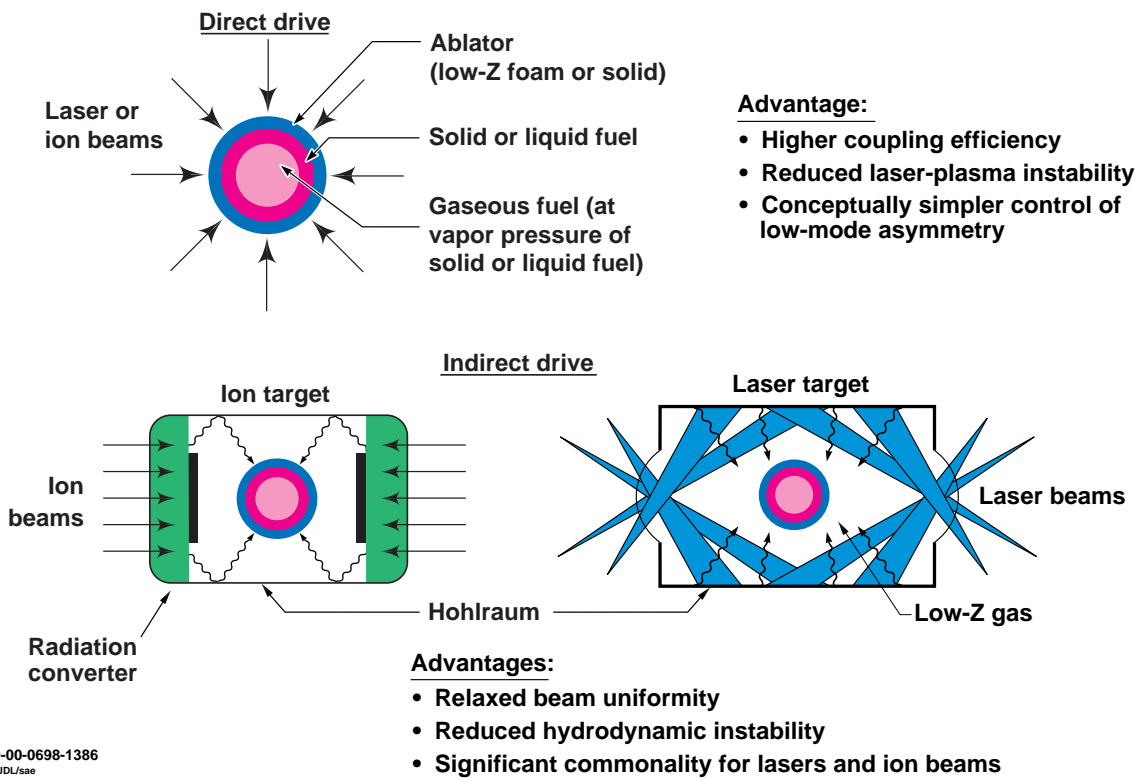
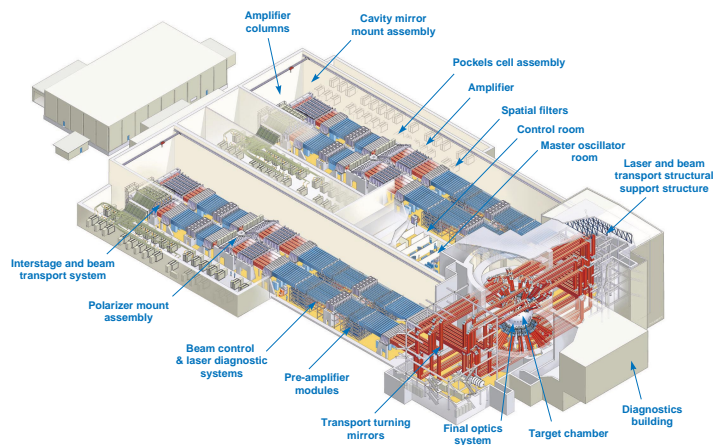

Fig. C.5. The two principal approaches to ICF are direct drive and indirect drive.

I-1. NATIONAL IGNITION FACILITY

Description

The National Ignition Facility (NIF), a key element of the Department of Energy–Defense Program (DOE–DP) Stockpile Stewardship Program, is a \$1.2B project scheduled for completion in FY 2003. It is a 192-beam, frequency-tripled ($\lambda = 0.35 \mu\text{m}$) neodymium:glass laser system being designed for routine on-target energy of 1.8 MJ and 500 TW of power, appropriately shaped in time. The powers of the beams will be balanced to 8% RMS, and each beam has a 50- μm pointing accuracy. The NIF laser is being designed to carry out three target shots per day. The laser and target area building is ~550 ft long and 360 ft wide. The 192 beams are delivered to the target chamber in 48 clusters of 4 beams. Indirect-drive targets of the type shown below have been the most thoroughly explored for testing on the NIF. However, the NIF target chamber is being constructed with additional beam ports so that both direct- and indirect-drive targets can be tested. NIF will be able to map out the ignition and burn propagation threshold for both target types and begin to map out the inertial confinement fusion (ICF) gain curves shown. If warranted by results of current research, the NIF could be modified to test fast ignition as well.



NIF illustrates many of the features of inertial fusion energy (IFE) development and will play a critical role in addressing IFE feasibility.

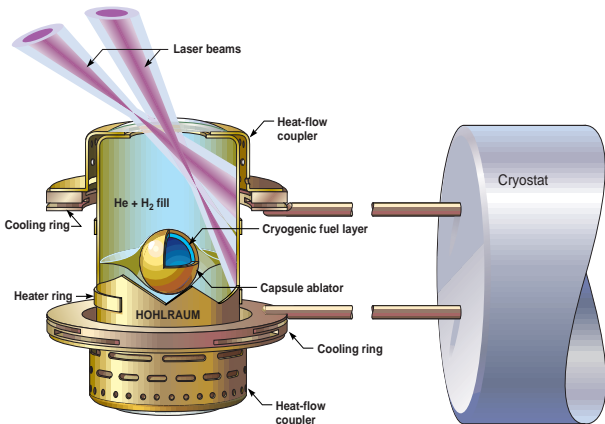

NIF ignition targets utilize precise laser beam placement for implosion symmetry and accurate thermal control for cryogenic fuel layer uniformity. The hohlraum for this target is about 1 cm in length.

Status

Groundbreaking occurred in May 1997, and the project is scheduled for completion at the end of FY 2003. The first bundle of eight beams is scheduled for completion at the end of FY 2001, and initial experiments will begin at that time. Activation of the facility will continue through FY 2004, and experiments using all 192 beams are scheduled to begin in FY 2005.

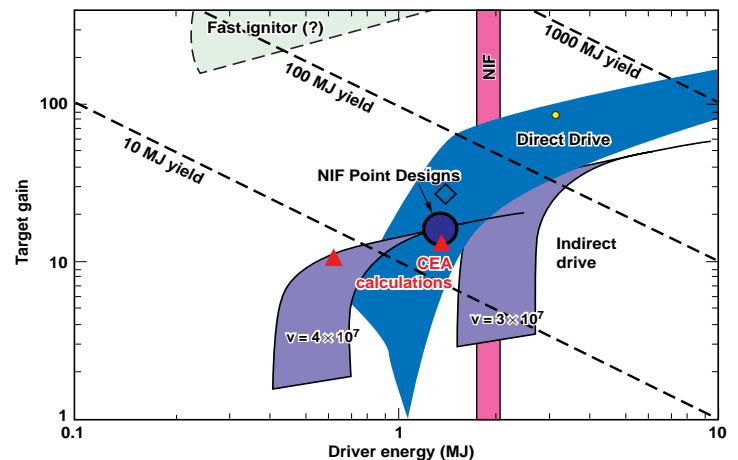

• Direct-drive design for KrF by NRL

NIF will map out ignition thresholds and regions of the gain curve for multiple target concepts.

Current Research and Development (R&D)

R&D Goals and Challenges

The fuel capsules for the NIF targets have exacting specifications. The shell containing the fuel must have surfaces smooth to a few hundred angstroms. CH shells for the Nova laser achieved this surface uniformity. However, shells for the NIF, made of CH, polyimide, or beryllium, are about a factor of 4 larger and have not yet been fabricated. The cryogenic fuel layer must be uniform to about 1 μm . This quality has been achieved in surrogate experiments, but tests are just beginning in NIF hohlraums.

Related R&D Activities

The French Commissariat à l'Énergie Atomique (CEA) is constructing the Laser Megajoule (LMJ), which will use largely the same technology as NIF. The LMJ has 240 beams and has goals very similar to those of NIF.

Budget

Congress has allocated \$790M of the \$1.2B total project cost. FY 1999 funding is \$291M.

Anticipated Contributions Relative to Metrics

Metrics

Both direct- and indirect-drive targets for IFE rely on central ignition followed by propagation of the burn via alpha deposition and electron conduction into the surrounding cold fuel. Once the hot central region of the fuel reaches 10 keV with a ρr equal to the range of the alpha particles ($\sim 0.3 \text{ g/cm}^2$ at 10 keV), the burn will propagate into and ignite an indefinite amount of surrounding cold fuel. These ignition and burn propagation conditions are nearly independent of fuel mass over a wide range of sizes. After ignition occurs, the burn wave propagates in ρr and temperature space in a way that is essentially independent of size. NIF fuel capsules are designed to absorb 0.1–0.2 MJ of X rays, while capsules envisioned for energy production typically absorb 1–2 MJ of X rays. Burn propagation into capsules throughout this size range track each other until the smaller capsules start to decompress. Thus, information for NIF capsules is widely applicable to capsules with larger yield and can be used to design the higher yield capsules generally appropriate for energy production.

Near Term <5 years

The NIF project is scheduled for completion in FY 2003 with full facility operation expected at the end of FY 2004. A National Ignition Plan is being developed. The goals of this plan are to develop the targets, diagnostics, and modeling tools that will be required for the ignition experiments.

Midterm ~20 years

Initial experiments on the NIF will concentrate on indirect-drive targets. Full activation of the NIF in FY 2004 will be followed by experiments to optimize the hohlraum drive and radiation symmetry. The start of ignition experiments is currently planned for FY 2006. Ignition experiments with indirect drive are expected to take 2–3 years for successful completion. Following the indirect-drive ignition experiments, the NIF beam geometry can be converted to the direct-drive configuration to begin direct-drive ignition experiments.

Following completion of the DOE–DP sponsored ignition experiments, tests of targets being evaluated for energy production could be conducted on the NIF. This could include, for example, tests of targets produced using fabrication techniques appropriate for mass manufacture. It will also be possible to use NIF for exposure tests of materials being considered for IFE chambers.

Proponents' and Critics' Claims

The NIF has the potential to test essentially all of the critical target physics issues for both indirect- and direct-drive targets being considered for IFE. Because the hohlraum wall physics and the fuel capsule physics issues are essentially the same for any X-ray source, indirect-drive experiments on lasers provide much of the target physics basis for ion-driven targets as well as laser-driven targets. A successful NIF target will demonstrate both ignition and the burn propagation required for high-gain IFE targets. Although success on the NIF cannot be guaranteed, 10 years of detailed experiments on the Nova and Omega lasers, along with underground nuclear experiments at the Nevada Test Site, have convinced external review committees that the potential for success on NIF justifies proceeding with the project.

Critics claim that laser-driven hohlraums for indirect drive are complex and are subject to failure because of laser-plasma interactions that are not yet completely understood. For direct drive, the laser beam smoothing requirements are not yet fully understood. It may turn out that the glass laser technology used in NIF will be unable to produce sufficient smoothing to achieve ignition with direct drive. Thus, both principal approaches to IFE could be unsuccessful on NIF. Although targets with ion beams or other laser technology might not be subject to the failure mechanisms that could occur on NIF, failure on the NIF would be a major setback for the IFE program.

I-2. INDIRECT-DRIVE INERTIAL FUSION ENERGY

Description

- The indirect-drive target consists of a spherical frozen deuterium-tritium (D-T) fuel capsule, imploded by thermal X rays absorbed in an ablator layer, inside a radiation case called a “hohlraum.” Intense beams of ions or lasers enter the hohlraum from two ends to heat the converters, generating soft X rays that in turn drive the capsule (indirect drive).
- Heavy-ion beams are the primary approach for indirect-drive inertial fusion energy (IFE), but lasers might be used for indirect drive if either laser efficiency or indirect-drive target gain can be improved by factors of 2–3. Pulsed power or light ion drivers might be used if stand-off or beam intensity requirements can be satisfied.
- Indirect-drive targets for IFE require total ion beam energies of less than 5 MJ for fusion yields of several hundred megajoules, a sufficient number of beams for symmetry, and a means to provide a shaped input pulse. Indirect drive can also be used to precompress fuel for subsequent fast ignition (see I-4).
- Chamber concepts for indirect-drive targets with two-sided illumination allow use of thick liquid flows to protect the permanent structural vessel and reduce activation.

Status

- Cylindrical target designs for two-sided heavy-ion beam illumination with distributed X-ray converters (see figure) produce 430 MJ of yield with total beam energies of 3.1 to 5.9 MJ, and designs for spherical hohlraums/illumination have been calculated to produce a 600-MJ fusion yield with a 12-MJ beam energy.
- Nova results for hohlraum laser plasma and hydrodynamic-equivalent physics have led to a reasonable expectation of achieving fusion gain >1 in the U.S. National Ignition Facility (NIF).
- Underground Halite/Centurion tests confirmed key indirect-drive concepts.

D-T fuel capsule with X-ray-heated ablator

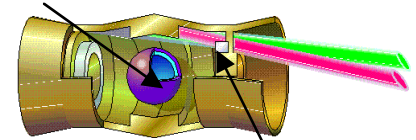

Heavy-ion beams heat X-ray converters inside hohlraum case (symmetric—one end shown).

Current Research and Development (R&D)

R&D Goals and Challenges

- Current heavy-ion target designs seek larger spot size, simplified pulse shape and symmetry with single ion energy beams, improved tolerance for beam-to-target misalignments (requires development of 3-D codes), and simplified construction with recyclable hohlraum materials for low-cost hohlraum fabrication.
- Reduced ion range in current indirect-drive target designs and use of ions with increased charge-to-mass ratio can both reduce accelerator beam voltage and capital cost, but both require some degree of space-charge neutralization in the target chamber to meet indirect-drive target focus spot size requirements.
- Current designs to improve laser indirect drive seek to increase target gain by use of hohlraum metal mixtures to reduce wall losses, smaller laser entrance holes, noncylindrical hohlraum geometries, lower hohlraum drive temperatures, and reduced hohlraum case-to-capsule ratios.

Related R&D Activities

- The United States leads world research in indirect-drive inertial fusion energy (IFE). There are smaller efforts in Japan, Russia, France, England, and Germany.
- The Department of Energy (DOE)–Defense Program (DP) in inertial confinement fusion (ICF) funds major efforts in indirect-drive target design, fabrication, experimental evaluation in the Nova and Omega Upgrade facilities, and the NIF to include indirect-drive ignition tests.
- Existing heavy-ion particle accelerators at GSI (Germany) are used to study heavy-ion target interaction physics relevant to indirect-drive IFE, but at single beam currents 10^{-4} of that required for a power plant. Upgrades to the GSI storage ring by 2000 will boost the peak current by 100 times or more.

Recent Successes

- Smaller versions of distributed radiator target designs suitable for a small IFE Engineering Test Facility (ETF) or demonstration reactor (DEMO) have recently produced 165 MJ of yield for 1.75-MJ beam input. Smaller 1.3-mm-radius beam spots may require shorter focal lengths for these reduced yield targets.
- Combinations of high-Z hohlraum materials show increased X-ray opacity and lower hohlraum wall loss.

Budget

- DOE–OFES: FY 1999 = ~\$9M (includes \$1M in heavy-ion target design and related liquid wall chamber R&D).
- DOE–DP (ICF): FY 1999 = ~\$500M (includes NIF construction).

Anticipated Contributions Relative to Metrics

Metrics

- For IFE with indirect drive to be attractive in the context of future energy competition, it is desirable to achieve a product of driver efficiency and target gain $\eta G > 20$ (a target gain >100 for a driver efficiency of 20%), a driver direct capital cost less than \$1B, and a driver continuous service life $>3 \times 10^9$ pulses. A sufficient number of beams and hohlraum smoothing of X rays must keep capsule X-ray flux uniform to within 1% during most of the pulse.
- Chambers with thick liquid walls must be developed that can be cleared for 5- to 6-Hz pulse rates.
- A target factory must be capable of producing 10^8 indirect-drive targets per year for a cost less than \$0.30 each. This implies a capital cost of equipment for mass production of targets less than \$100M.
- Hohlraum targets must be injected at velocities of ~ 100 m/s at >5 Hz, with stability of capsule mounts inside the hohlraum and beam-to-target tracking errors less than 150 μm rms.

Near Term <5 years

- The robustness of indirect-drive targets to manufacturing imperfections and to beam-target alignment errors during injection needs to be assessed with three-dimensional (3-D) target design codes that also need further development.
- Scaled experiments on chamber plasma neutralization of space-charge-dominated ion beams are needed to validate 2-D and 3-D PIC code simulations of focusing to indirect-drive target spot sizes.
- Designs need to establish consistency between indirect-drive target designs for IFE with the required number of beams, target spot size, final focus distance (stand-off), and driver-chamber interface neutron shielding.

Midterm ~20 years

- The NIF will use a 1.8-MJ laser to test indirect-drive fusion ignition and gain by ~ 2007 . NIF will test much of the physics concerning indirect drive with heavy ions, including hohlraum radiation transport and capsule symmetry, pulse shape, and ablator optimization.
- In parallel with the NIF, prototypes of candidate drivers for indirect-drive need integrated tests of beam quality and pulse shape sufficient to meet indirect-drive target requirements for a few individual beams, with several meters stand-off distance from final focus to the target, and at IFE-relevant pulse rates.
- Models for chamber clearing need to be validated for candidate target chamber designs for indirect-drive, using scaled chamber clearing experiments and from high-energy experiments on the NIF or other single-shot high-energy ICF facilities.

Long Term >20 years

- Following the NIF, an ETF is needed to generate sufficient average fusion power to test candidate IFE chambers; tritium fuels cycle, and high-pulse-rate target fabrication and injection. Indirect drive facilitates the possibility of using a beam switchyard for one driver to test multiple chambers.
- After a suitable chamber for IFE power plants is developed in the ETF, a small electricity-producing IFE pilot plant or DEMO may follow either as a new higher-fusion power facility or as a chamber upgrade re-using the ETF driver. Indirect-drive beam transport geometry can facilitate chamber upgrades.
- Advanced indirect-drive IFE approaches may be explored in the long term, including use of outer hohlraum shells to reduce X-ray ablation and enhance plasma direct conversion, hohlraums driven from a single end, and indirect drive hybrids for fast ignition, driving large ρr capsules capable of self-tritium breeding.

Proponents' and Critics' Claims

- Proponents claim that indirect drive with X-ray-driven ablation reduces the risk of hydrodynamic instabilities quenching ignition due to fuel-hot-spot mix during implosions and that the majority of DP-ICF target physics supports this conclusion. Proponents further claim that two-sided beam illumination with indirect-drive facilitates the use of liquid-walled chambers to increase chamber lifetime and reduce long-term waste generation. Proponents claim that hohlraums are low precision compared to the capsule and that radiation smoothing in the hohlraum allows a greater tolerance for beam-target alignment errors. The hohlraum can protect the capsule during injection into hot chambers.
 - Critics claim that indirect drive will prove to have lower target gain than direct drive, increasing the driver recirculating power for a given driver efficiency; in particular, this could be a real obstacle to laser-driven indirect drive. Critics believe that the cost of IFE targets will be higher for indirect drive because of the added hohlraum cost. The potential buildup of activated high-Z hohlraum materials in the fusion chamber may pose a significant safety and waste hazard.
-

I-3. DIRECT-DRIVE INERTIAL FUSION ENERGY

Description

In the direct-drive inertial fusion concept, the target is a spherical shell, ~5 mm in diameter, consisting of frozen deuterium (D)-tritium (T) surrounded by an ablator. The target ablator is symmetrically heated by about 60 laser beams, generating pressures of 50–100 Mbar that then implodes the cold D-T fuel to densities of ~400 g/cm³, with a central hot spot of 5–10 keV for fuel ignition. Specific ablator materials are chosen to avoid, or minimize, laser-plasma and hydrodynamic instabilities.

- The laser specifications include a temporally tailored pulse shape, a short wavelength, optical beam smoothing with a broad bandwidth, sufficiently low capital and maintenance costs, and sufficiently high efficiency.
- Chamber concepts may be environmentally attractive, with low radioactivity, if a simple dry carbon wall can be employed.
- The direct-drive approach has the potential for high target gains that are necessary to compensate for the inefficiency of the laser. Direct-drive targets may also be possible with heavy ion beams; this would reduce the requirements on the total ion energy and thus on the capital cost of the accelerator.

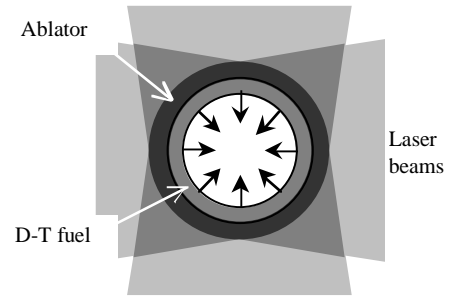

Status

- Preliminary laser fusion target designs exist with energy gains above 100, which is sufficient for economic electric power.
- Laser fusion power plant studies predict environmentally benign systems with a cost of electricity ~\$0.06/kWh.
- Spherical multibeam irradiation experiments on the Omega glass lasers achieved convergence ratios of 28. Gekko implosions achieved compressions of 600 times solid density.
- On planar targets, the Nike krypton fluoride (KrF) laser has demonstrated a laser nonuniformity of 1% rms in each laser beam and accelerated targets with 37 beams with a mass imprinting equivalent to ~100 Å.
- The Nike KrF laser and the Omega glass laser evaluated the laser-target coupling and hydrodynamics of the direct-drive target designs; results are in good agreement with the theoretical modeling.
- The National Ignition Facility (NIF) now under construction by Department of Energy (DOE)–Defense Programs (DP); could be modified in 2008 to produce uniform illumination of direct-drive targets, thereby providing a proof-of-performance for fusion energy.

Current Research and Development (R&D)

R&D Goals and Challenges

- The “Mercury” diode-pumped solid-state laser (DPSSL) and the “Electra” KrF laser are modest-size, 5- to 10-Hz (100- and 400-J) facilities now under development. Both must demonstrate sufficient durability, total efficiencies of 5–10%, cost reductions, and sufficient beam uniformity.
- Solid state lasers do not currently meet the beam uniformity requirements for high gain targets. Design improvements in the laser and target are being developed that may meet the final fusion symmetry requirements.
- Laser-target experiments are continuing the evaluation of the sensitivity of the target designs to laser beam nonuniformities, hydrodynamic instabilities, and laser-plasma instabilities.
- Uncertainties need to be resolved in the chamber wall lifetime, the final optics protection, and the target injection technique. Because there has been very limited research in these topics, significant improvements are possible.

Related R&D Activities

- DOE–DP funds the computational and experimental evaluation of direct-drive target designs using the Omega and Nike lasers.
- The United States is the dominant player in direct-drive laser fusion. There are smaller efforts in Japan and Europe.
- The mainline effort in DOE–DP emphasizes the “indirect-drive” target design using lasers; there is substantial scientific overlap in the target concepts and in the various laser technologies. The British and French nuclear weapons laboratories also have large investments in the indirect-drive laser fusion concept.

Recent Successes

- Acceleration of flat foils with Nike had 100 Å imprinting by the laser nonuniformities. The measured hydrodynamic instability growth was in reasonable agreement with computer simulations. The foils have consisted of both solid plastic and low-density plastic foams filled with cryogenic D-D.
- Initial Omega measurements of laser-plasma instability thresholds with optically smoothed laser beams indicates that the direct-drive target designs will have negligible laser-plasma instabilities.
- Diodes for pumping of solid state lasers have reached 50% efficiency.

Budgets

- DOE–DP, KrF lasers: FY 1999 = \$9.5M for Nike laser-target studies; \$7.7M to initiate repetition-rated Electra laser.
- DOE–DP, glass lasers: FY 1999 = \$27.6M for Omega laser-target studies; \$2.3M to enhance repetition-rated Mercury laser.
- Japanese laser fusion energy program = ~\$10M.

Anticipated Contributions Relative to Metrics

Metrics

- **Laser:** Wavelength $\leq 0.35 \mu\text{m}$; bandwidth $> 1 \text{ THz}$ with optical smoothing; low-mode distortion $< 2\%$ /beam; wall plug efficiency $\geq 5\%$; capital cost $< \$400/\text{J}$; and durability $\sim 3 \times 10^8$ shots between major maintenance.
- **Target:** Energy gains above 100 with laser energy $\sim 3 \text{ MJ}$; $\sim \$0.20/\text{target}$ cost; inner surface D-T nonuniformities $< 0.5 \mu\text{m}$; outer surface ablator nonuniformities 100–500 Å; withstand 10–100 g acceleration into chamber; withstand the infrared heating of cryogenic D-T during flight through the chamber.
- **Chamber:** First wall does not melt from target explosion, resulting in approximately 3 years of chamber life; laser beam can propagate to target without distortion or ionization; final optic can survive neutron, X-ray, and particle debris; optical aiming precision onto pellet for each shot $\sim 10 \mu\text{rad}$; less than 200 g of tritium inventory.

Near Term ≤ 5 years

- **Laser:** Demonstrate KrF laser (Electra) and DPSSL (Mercury) that meet all of the laser requirements except durability and capital cost. The lasers will demonstrate 10^5 shots between maintenance and provide a reasonable basis for estimating cost. Demonstrate that a glass laser (NIF and/or Omega) can meet the laser beam uniformity requirements of direct-drive targets.
- **Target:** Complete initial computational and experimental evaluation of all of the critical physics elements of high-gain direct-drive targets, except for actual demonstration of high-gain implosions. Demonstrate target fabrication that meets smoothness criteria. Demonstrate acceleration of simplified targets into simplified chamber. Successfully implode scaled-down fusion target using Omega glass laser.
- **Chamber:** Theoretically evaluate remaining uncertainties in baseline chamber concept along with some experimental tests.

Midterm ~ 20 years

- **Laser:** Build and optimize just one beam line of a KrF laser and/or DPSSL that would meet all of the requirements for a fusion power plant, providing detailed justification of costing and 10^8 shots between major maintenance. This laser could then be duplicated many times at fixed and known cost for a demonstration power plant.
- **Target:** Direct-drive target will be imploded using the NIF, with energy gains consistent with modeling; they would scale to gains above 100 in a fusion power plant. Demonstration that the targets can be built for $\sim \$0.20$ each. Acceleration of fusion cryogenic target into a hot chamber that simulated the fusion chamber.
- **Chamber:** Experimental evaluation of all major uncertainties in chamber system, other than sufficient neutron irradiation. Neutron irradiation that may scale to a fusion power plant.

Long Term > 20 years

- **Laser:** Construct few-megajoule laser, by replicating the single beam line described above.
- **Target:** Build prototype target factory. Inject targets into chamber, implode them, and produce gains above 100.
- **Chamber:** Build scaled-down version of chamber. Reduce yield of target. Concentrate research on engineering optimization of chamber, then build full-size chamber, and add balance of power plant. Produce useful electric power.

Proponents' and Critics' Claims

- Proponents claim that the inertial fusion option can produce electricity in 2025 at a cost comparable to advanced fission and coal, the other two long-term competitors. They claim that the environmental impact is low because the first wall can be made with low-Z materials. They claim that the development path is inexpensive because only one beam line of the laser has to be developed to determine the driver costs, the time duration to a demonstration power plant is relatively short, and the program can take advantage of the large investments in laser fusion by DOE–DP. Proponents of KrF emphasize their laser beam quality, and the possible solutions for the durability uncertainties. Proponents of the DPSSL emphasize their potential for higher laser efficiency and the durability of solid-state devices.
 - Critics note that the major efforts by DP have been in the areas of target design and laser-target interaction, not chamber design, and they question whether the chamber can ever be built reliably at acceptable cost with acceptable lifetime against neutron irradiation and acceptable tritium inventory. They question whether low-cost targets can be built and still meet the stringent surface smoothness criteria and whether the targets can be successfully injected into a hot chamber. They also question whether the final optic can withstand the fusion output. For KrF lasers, they question the efficiency, the reliability, and cost of megavolt pulsed power and cost of risks of a laser cell with corrosive fluorine gas. For the DPSSL, they question whether the capital cost of the diodes can be sufficiently reduced, whether the laser beam can meet the uniformity requirements of direct drive, and whether the advanced crystalline medium can be made into a practical laser medium.
 - Proponents note that very little effort has been devoted to designing symmetric illumination targets with a heavy ion driver. Proponents suggest that by combining symmetric illumination with a radiation tamper, it may be possible to reach gains above 100 with less than 2 MJ of ion energy.
 - Critics question whether heavy ions can produce sufficiently smooth and symmetric illumination for direct-drive targets.
-

I-4. FAST IGNITION APPROACH TO INERTIAL FUSION ENERGY

Description

The fast igniter is an exploratory inertial fusion energy (IFE) concept in which ignition is accomplished by rapid injection of external heat after the fuel has been compressed to the required density (200–900 g/cm³). The ignition is so fast that the ignition region and main fuel can be far from pressure equilibrium. The ignition region by itself is inertially confined in this concept. For a given hot ignition zone $\rho r_{\text{hot}} \sim \alpha$ range, the energy in the smaller, high-density isochoric ignition zone is smaller than in the larger low-density isobaric ignition zone by a factor of $\rho_{\text{hot}}^2 / \rho_{\text{cold}}^2$, and thus the target

gain can be higher using fast ignition. Because the kinetic energy of the imploding shell can all go into fuel compression in the fast igniter case, fast ignition supports either higher final ρr for a given implosion velocity v_{imp} and fuel mass M_{DT} or allows lower ρ with larger r and M_{DT} for a given final ρr .

The scheme is divided into three phases. First, the fuel is compressed conventionally. The driver can, in principle, be either a laser or an ion beam, and the energy can be deposited either directly or indirectly via X rays. Second, a path through the coronal plasma remaining from the implosion is bored with a laser beam with intensity about 10^{18} W/cm². Finally, a laser beam with intensity in the range 5×10^{19} – 5×10^{20} W/cm² couples 20–100 kJ to the compressed fuel, heating it to ignition. If an ion beam with the proper range can focus to this intensity, it would be an ideal ignition driver. After ignition, burn propagation and high gain follow. Simple models give the gain (driver energy) curve a factor of 5–20 higher than the conventional inertial confinement fusion (ICF) gain curves. Gain that is adequate for energy applications occurs with driver energy a factor of 3–10 lower than the conventional schemes. These estimates are highly uncertain.

Status

The Nova petawatt laser has delivered 700 J in less than a picosecond with peak focused intensity in excess of 10^{20} W/cm². There are schemes (chirped pulse amplification using dielectric transmission gratings) that may increase the delivered energy to tens of kilojoules affordably. A number of calculations have been performed in the United States, Europe, and Japan, indicating energies of 10–100 kJ required to be coupled to the fuel for ignition in equimolar deuterium-tritium (D-T) mixtures and even in tritium-lean fuel mixtures. It remains uncertain if hot electrons from high-intensity lasers can be delivered to a compressed core. Minimizing the amount of coronal plasma in the beam path is key. Asymmetric implosion systems may help in this regard. After the hot electrons are created at critical density, they must propagate up a density gradient to the ignition region. Magnetohydrodynamic calculations suggest that the electrons form a warm beam, while particle-in-cell (PIC) calculations suggest some jet formation in the electron current. There is experimental support for both of these theoretical claims.

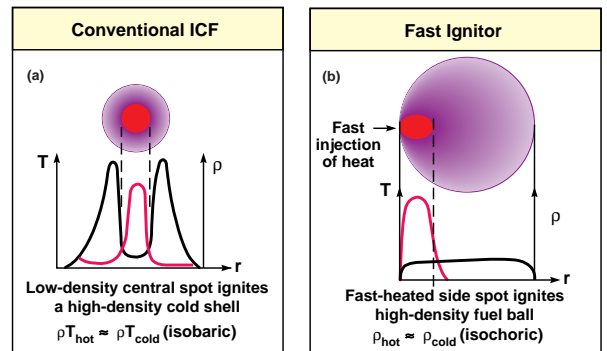

Current Research and Development (R&D)

R&D Goals and Challenges

- Temperature measurements are needed of solid-density material heated with a short-pulse laser. The Nova petawatt has a goal of reaching 2 keV at solid density.
- Integrated design calculations are needed for the implosion phase, hole-boring phase, and high-intensity heating phase, using the best available computational tools.

Related R&D Activities

- The Gekko XII laser facility at ILE has a thirteenth beam line for fast ignition experiments, but short-pulse energies have been limited to less than 100 J due to grating limitations. The system can be upgraded to the kilojoule level in the future. The Osaka group has managed to achieve an adequate laser alignment and timing accuracy to couple to an imploded direct-drive target core.
- There are significant fast-igniter research efforts at the Rutherford-Appleton Laboratory in England and numerous university experiments at the 1-J laser level at intensities above 10^{18} W/cm².

Recent Successes

- Detailed PIC simulations indicate that up to 30–100% of the laser energy can be coupled to the plasma at sufficiently high intensities.
- Recent experiments at 10^{19} W/cm² show coupling to hot electrons in excess of 40%.

Budget

Department of Energy–Defense Programs (DOE–DP) funded an ICF university research grant at Princeton Plasma Physics Laboratory and internal laboratory support at Lawrence Livermore National Laboratory and General Atomics.

Anticipated Contributions Relative to Metrics

Metrics

- Drive uniformity. Compression: unknown requirement, but less stringent than for conventional targets. Ignition: igniter beam must hit the precompressed core anywhere the density exceeds about 300 g/cm^2 .
- Drive intensity. Required 5×10^{19} – 5×10^{20} and achieved 2×10^{20} .
- Short-pulse energy. Required 20–200 kJ and achieved 700 J.
- Repetition rate. Required 3–10 Hz and achieved petawatt 2 Hz/d and diode-pumped solid-state laser (DPSSL) 10 Hz.
- Spot size. Required 10–60 μm and achieved 30% of energy in 10 μm .
- Pointing accuracy. Required 10–100 μm and achieved 50 μm .
- Relative timing between ignition and compression pulses. Requirement <75 ps and demonstrated <10 ps in laser timing. Uncertainty in implosion timing is larger than this. Improved implosion timing predictions will be obtained in the conventional ICF programs.
- Target gain /driver efficiency. Gain theoretically in range of 300–1000. Tolerates driver efficiency in 1–3% range. Fusion pellet fabrication tolerances—unknown.
- Optical material requirements. High-pulse-rate DPSSL. High (2-J/cm^2) damage limit for diffraction gratings. Demonstrated 10-Hz DPSSL in small system, 6 J/cm^2 in SiO_2 flats in 60-ps pulse, and 0.3-J/cm^2 gold grating for 0.5 ps.

Chamber geometry. Possibly consistent with liquid-protected chamber designs and one- or two-sided illumination. Modularity: High intensity has already been achieved. Future hardware must maintain intensity in larger spot and for longer times.

Science. New area of relativistic plasma physics, gigagauss magnetic fields, high current beams (one-way current $\sim 10^9 \text{ A}$). At higher intensities it can create copious electron-positron pairs. Some evidence exists that currents form filamentary structures. The interaction of these structures may be related to currents in solar atmospheres.

Nonfusion applications. The short-pulse technology has numerous spin-offs for material processing and machining, laser surgery, and dentistry. At high intensities, there is a DOE–DP application to produce high-intensity X rays that might also be used for treatment of cancer.

Near Term <5 years

- An integrated target design for the National Ignition Facility (NIF).
- Electron transport theory improvements to better predict experiments.
- Design of laser implementation for NIF with cost of $\sim \$50\text{M}$.

Midterm ~20 years

- Demonstration of high gain on the NIF using fast ignition.
- Identification of a long-lasting or disposable final optic for the fast igniter beam (e.g., plasma mirrors).

Long Term >20 years

- Following the NIF, an engineering test facility and then a small electricity-producing demonstration reactor are needed. Fast ignition, if successful, might lower the cost of such facilities.
- Advanced fast ignition IFE approaches may be explored in the long term, including fast ignition driving large pr capsules capable of self-tritium breeding (no breeding blankets) and high yields with use of outer hohlraum shells to enhance plasma direct conversion.

Proponents' and Critics' Claims

Proponents claim that this is the most attractive way to achieve competitive fusion energy with lasers. Critics claim that there has been insufficient concept development, that it will be impossible to localize the energy deposition in space and time required for ignition, that the laser beam will be scattered by various plasma processes, that electron transport will be inhibited, and that the electrons will not efficiently carry energy from the critical surface to the ignition region. Neutron damage problems associated with all laser schemes persist. With improvements in optics, sufficient standoff may be possible even for the short-pulse laser (the diffraction-limited spot would be 60 μm at 1- μm wavelength with a final optic of 1-m diameter at 50 m). It may be impossible to adequately protect igniter final optics from target debris and X-ray and neutron damage so that disposable plasma mirrors may have to be employed. A proponent might respond that an aggressive design and experiment program would resolve the physics issues and that current experiments have more optimistic results than the worries of the critics.

I-5. HEAVY ION ACCELERATORS FOR FUSION

Description

- The goal of the Heavy Ion Fusion (HIF) Program is to apply high energy and induction accelerator technology to inertial fusion power production. Heavy ions ($A > 80$) at ion kinetic energies of 1–10 GeV have an ion penetration depth appropriate for inertial fusion targets. Multistage accelerators can readily produce such energies.
- Several types of accelerators are being developed. Radio frequency (rf) linacs (followed by storage rings) and induction linacs (without storage rings) are currently the favored approaches. The differences between these two approaches are comparable to the differences between gas lasers and solid-state lasers. All heavy ion approaches are, in the United States, considered to be a single option, whereas for historical and institutional reasons, the different types of lasers are often considered to be different options.
- For ions there is a continuum of targets ranging from full direct drive to full indirect drive. The high efficiency of accelerators allows consideration of the full range, including indirect drive, the baseline approach for the National Ignition Facility (NIF). Moreover, indirect drive allows two-sided illumination, a geometry well matched to chambers with thick liquid wall protection. Such walls endow deuterium-tritium (D-T) fusion with many of the attributes of advanced aneutronic systems. Most U.S. studies of power plants for heavy ion fusion have assumed indirect drive and thick liquid wall protection, but there are other options.

Status

- Existing proton and electron accelerators are comparable to power plant drivers in terms of size, cost, total beam energy, focusing, average beam power, pulse repetition rate, reliability, and durability. High peak power (or current) is the new requirement. Because fusion targets require beam powers of 100–1000 TW, 10 kA–1 MA of total beam current is required on target. Use of multiple (~100) beams and pulse compression after acceleration (10X or more) implies a power of ~0.1–1 TW/beam out of the accelerator; at ~3 GeV this is 30–300 A. Typical driver designs compress the pulse length and so require injected currents of ~1A/beam or less from a 2-MeV injector. For comparison, the ISR at CERN had a beam power of 1 TW at 30 GeV. Most experiments to date have been scaled, using beams of 10–20 mA, but they have tested critical beam physics in the right dimensionless regime, for example, with driver-relevant dimensionless perveance (essentially the squared reciprocal of the distance in beam radii that an unconfined beam can travel before expanding by one beam radius) of up to $\sim 4 \times 10^{-4}$, and driver scale “tune depressions” (the ratio of transverse betatron frequency in the presence of space charge to that in the external field alone) of order 0.2. Current amplification by a factor of a few has been achieved.
- Lasers are well suited to near-term target physics experiments and to the needs of the Department of Energy’s (DOE’s) Defense Programs, so there has been no need to develop large accelerators for these purposes. Consequently, the HIF Program has emphasized theory, numerical simulation, and small scaled experiments to address the key issue of focusing high current heavy ion beams. Scaled experiments addressing all systems and beam manipulations in a full-scale driver have been completed or are nearing completion and, in agreement with theory and simulation, suggest that it will be possible to achieve adequate focusing.
- Studies of heavy ion power plants predict favorable cost of electricity compared to most other fusion options. These studies assume that it will be possible to fabricate targets inexpensively, that liquid-wall target chambers can be cleared rapidly, and that cost-effective drivers can be built; all of which must be validated.

Current Research and Development (R&D)

R&D Goals and Challenges

- More completely validate beam focusing at high current. Pursue a low-cost development program leading to low cost of electricity. Contribute to fusion science, plasma science, and accelerator science and technology.
- In the near term, increase the current in beam physics experiments to full driver scale.
- Develop an end-to-end numerical simulation capability for heavy ion fusion.
- Work with industry to develop and reduce the cost of accelerator components, for example, superconducting quadrupole arrays, ferromagnetic materials, cast insulators, and pulsers.

Related R&D Activities

- The large worldwide research programs in accelerators for high energy and nuclear physics, biology, materials science, other basic sciences, and defense.
- The research programs in heavy ion fusion in Western Europe, Russia, and Japan.
- The light ion fusion programs, particularly with respect to chamber transport and beam-target interaction physics.
- The Defense inertial confinement fusion (ICF) program in targets and the magnetic fusion energy (MFE) programs in simulation, materials, and magnet technology.

Recent Successes

- Completion or near completion of small scaled experiments addressing all systems required in a full-scale driver, including a focusing experiment that produces millimeter focal spots, an experiment that combines four beams transversely while retaining good beam quality, experiments on beam bending, a target injection experiment that demonstrated adequate accuracy for indirect drive, and injector experiments.
- Substantial progress toward an end-to-end simulation capability, for example, a three-dimensional (3-D) PIC code for heavy ion fusion.
- Establishment of industrial contracts to reduce the cost of key components by large factors.

Budget

DOE–OFES: FY 1999 = ~\$8M for accelerators and ~\$2M additional for related chamber research and target design.

Anticipated Contributions Relative to Metrics

Metrics

- An inertial fusion energy (IFE) driver must deliver 1–10 MJ of energy at a peak power ≥ 100 TW. The beams must be focused to a radius of a few millimeters from a distance of several meters. The focusing system must survive in a fusion environment. The pulse must be properly shaped, and the beams must be accurately aimed. The driver must be efficient, reliable, and durable. It must have a high pulse repetition rate and good environmental characteristics.
- The near-term development path must be affordable—a modest fraction of the total OFES budget—and the cost of electricity must be competitive. Studies show that meeting a cost-of-electricity price goal of \$0.05/kWh requires a driver direct cost of \$0.50/W(e) (\$500M, for a 1-GW power plant).
- The beams are focused onto the target by magnetic fields, and the conductors that produce these fields must be shielded adequately from neutrons, gamma rays, and other fusion products so that the final optical elements can survive in the fusion environment; this is believed possible based on preliminary calculations.
- The new scientific issue in adapting accelerator technology to inertial fusion is to produce the high beam currents required to ignite targets while retaining the well-established ability of accelerators to deliver beams that can be extremely well focused, particularly in the fusion chamber environment. Control of pulse shape and cost are the other metrics that require particular attention.

Near Term <5 years

- Complete the present scaled experiments.
- Develop an end-to-end simulation capability.
- Complete beam physics and injector experiments at driver scale.
- Develop inexpensive quadrupole arrays, pulsers, insulators, and ferromagnetic materials for induction cores.
- Design and begin to build a multi-kilojoule accelerator facility [an integrated research experiment (IRE)] that will do definitive experiments in accelerator science, beam focusing, chamber physics, and those aspects of ion target physics that cannot be done on laser facilities such as the NIF.
- Work closely with target designers to develop targets that are optimized for heavy ion accelerators.

Midterm ~20 years

- Build the IRE and use it for beam physics, target physics, focusing, and chamber experiments.
- After completing the IRE program, develop and build a full-scale driver. This driver may use much of the IRE hardware. (Because of their long life, upgrading and reuse of components are the norm for accelerators.)
- Begin full-scale chamber experiments.

Long Term >20 years

- Complete full-scale chamber experiments and build a demonstration power plant using the existing driver to minimize cost.

Proponents' and Critics' Claims

Proponents claim that the reliability, durability, high repetition rates, and high efficiency of accelerators are important advantages for the heavy ion approach to inertial fusion. High efficiency enables the use of indirect drive and chambers with thick fluid walls, a chamber option that appears highly advantageous. Proponents believe that the existence of a plausible solution to the survivability of final optics is particularly important. They believe that the heavy ion approach has low development cost because much of the target physics will be done by Defense Programs and because of the synergism with high energy physics, nuclear physics, and magnetic fusion. Moreover, because of their modular nature and long life, accelerators can be upgraded. The first accelerator capable of driving a target to high gain can be used as the driver for a demonstration power plant.

In addition to concerns (e.g., target fabrication costs) that are common to all IFE approaches, critics claim that the heavy ion approach is expensive, and they question whether intense beams can be focused, particularly in a fusion environment. Critics question the practicality of a fluid-walled chamber with a 5- to 10-Hz repetition rate. Evidently, the critics and the proponents agree on the issues, but differ in their optimism.

I-6. REPETITION-RATE KRYPTON FLUORIDE LASER

Description

The krypton fluoride (KrF) laser is an excited dimer (excimer) laser that produces broadband light (2 THz) centered at 248 nm. For the high-energy systems required for inertial fusion energy (IFE), the gas is pumped by large-area electron beams. The electron beams are formed in a rectangular cross-section diode and transported into the laser cell from opposite sides and in a direction perpendicular to the laser beam. Magnetic fields are usually used to guide the beams and prevent self-pinching. The decay time for the excited dimer is ~6 ns, whereas the typical pump time for the electron beam is a few hundred nanoseconds. The mismatch in time scales is resolved with angular multiplexing: a train of laser pulses, typically a few nanoseconds long, is sequentially passed through the amplifier and then recombined on target. Thus, KrF systems tend to have many mirrors and few amplifiers. One distinguishing feature of KrF is its outstanding beam quality: KrF has the best target illumination uniformity of any high-power ultraviolet (UV) laser.

Status

All the large KrF lasers (energies of 1 kJ or greater) are single-shot devices developed for the ICF program or for basic science experiments. The Nike laser at the Naval Research Laboratory (NRL) has been in operation for 3 years and has demonstrated that a KrF laser can be a reliable target shooter (over 600 shots per year). Nike has demonstrated the technology for aligning a large number of laser beams. It has also shown that laser energy and spatial profile are in good agreement with the design codes. In fact, target experiments show that the laser imprint with the very uniform Nike beam is less than the anticipated manufacturing defects on the target surface. It appears that KrF meets the target physics requirements for IFE.

Current Research and Development (R&D)

R&D Goals and Challenges

The R&D goal and challenge is to demonstrate that a KrF laser can meet the fusion energy requirements for repetition-rate, reliability, efficiency, and cost. The key issues are the efficiency, durability, and cost of the pulsed power driver; the lifetime of the electron beam emitter; the durability and efficiency of the pressure foil support structure (“hibachi”) in the electron-beam-pumped amplifiers; the ability to clear the laser gas between pulses without degrading the beam quality; and the lifetime of the amplifier windows and optics in the laser cell. Technologies have been identified that can address these issues. Most have been partially developed elsewhere, but they have been developed separately from each other and not necessarily in a parameter range appropriate for IFE. NRL has generated a conceptual design for a modest-size repetition-rate KrF laser that will allow the development and integration of these technologies specifically for IFE. The laser would have an optical aperture of 30 cm, an output of around 600 J, and would run at 5 Hz. This laser is called Electra.

Budget

In the Department of Energy–Defense Programs (DOE–DP), a new program should be started to deliver a spark-gap-based pulsed power supply with the parameters required for Electra. This power supply will not have the durability or efficiency required for IFE, but it will be sufficient to develop the other technologies, that is, emitter, pressure foil, and gas recirculator. An appropriate power supply will be added later.

Anticipated Contributions Relative to Metrics

Metrics

The requirements identified for IFE are based on the SOMBRERO Reactor study, which showed that a fusion power plant based on a KrF laser can be economically competitive, on target experiments with Nike, and on the NRL target designs, which show that an implosion driven by a laser with the smoothness of KrF could likely achieve the high gain required for IFE:

Overall system efficiency	6–7%
Repetition rate	5 Hz
Durability (shots between major maintenance)	5×10^8 (3 years)
Cost of entire driver	\$170.00/J
Total driver energy	3.4 MJ
Beam quality for high-mode fluctuations	0.2%
Optical bandwidth (based on current target designs)	2.0 THz
Beam quality for low-mode distortion	1–2%

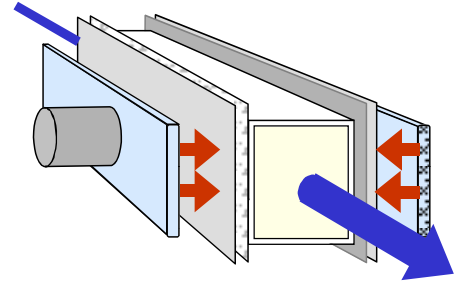

Near Term ~5 years

- On Electra (30-cm aperture, 5-Hz, repetition-rate laser): (1) Demonstrate durability and efficiency of repetition-rate pulsed power system from prime power to the energy deposited into the gas. (2) Demonstrate ability to repetitively amplify a high-quality laser beam that meets the requirements for bandwidth and beam quality. (3) Develop technology to meet requirements for pulsed power cost.
- On Nike (60-cm amplifier, single shot): Demonstrate intrinsic efficiency (laser energy out divided by laser energy in the gas) and electron beam transmission through the hibachi with a large system that is directly scalable to an IFE laser beam line.
- In separate, off-line, experiments: Develop new window coatings for the amplifiers.

Midterm ~20 years

- Develop a full-scale KrF amplifier that meets all the requirements for IFE. The laser output of this amplifier will be in the range of 30–100 kJ, with an optical aperture around 2 m². The amplifier will run at 5 Hz and should be the prototype for an IFE beam line.
- Incorporate this prototype into an Integrated Test Facility, that is, a laser that meets the requirements for IFE.

Long Term >20 years

- Build an IFE engineering test facility based on a KrF driver.

Proponents' and Critics' Claims

Proponents claim that only KrF has the beam uniformity required for high gain; that it is entirely feasible to build a laser that meets the fusion energy requirements for durability, efficiency, and cost; and that the favorable target physics make this an excellent approach for fusion energy. Critics claim that KrF will never achieve the required efficiency and that it will be difficult to meet the durability requirements.

I-7. SOLID-STATE LASER DRIVERS

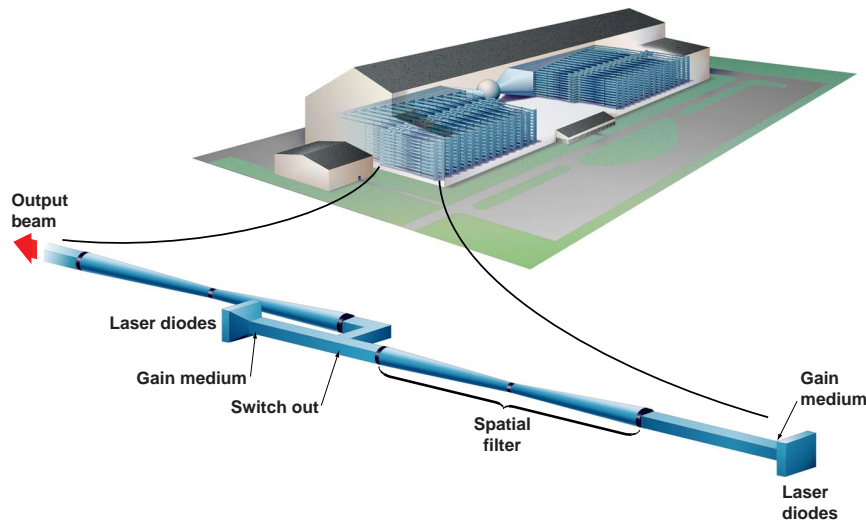

Description

- Since the earliest days of inertial fusion research, solid-state lasers have served as the main workhorses for unraveling crucial target physics issues.
- First-generation solid-state lasers, initially at the 100-J level in early 1970s and based on flashlamp-pumped neodymium (Nd):glass, will culminate with the 1.8-MJ National Ignition Facility (NIF).
- To attain the objectives of fusion energy, second-generation solid-state lasers will employ diodes in place of flashlamps, ytterbium (Yb)-doped crystals instead of Nd:glass, and near-sonic helium cooling of optical elements.

Status

- Researchers completed an inertial fusion energy (IFE) power plant study based on diode-pumped solid-state lasers (DPSSLs); discovered Yb:sulfur (S)-FAP laser material with long storage time; demonstrated 1-J integrated test bed of gas-cooled diode-pumped Yb:S-FAP crystal laser; and radiation-tested proposed final optic material at 0.1 dpa.
- Lawrence Livermore National Laboratory scientists are building the first major technology step toward a viable solid-state laser driver for IFE, referred to as the Mercury Laser. Performance goal is 10% efficiency with 10-Hz repetition rate, 100 J/pulse, 2-ns pulse width, 5X diffraction-limited beam, and 1.05- μm wavelength.
- Laser diode pump arrays with up to 50% efficiency are commercially available and being used in DPSSLs for many applications.
- NIF employs a diode-pumped oscillator and regenerative amplifier for compactness and stability.
- Japanese researchers at Osaka University have initiated development of DPSSLs as IFE drivers.

Current Research and Development (R&D)

R&D Goals and Challenges

- Ultimate goals for solid-state lasers are 5–20% efficiency, 1% low spatial-mode uniformity on target, 10^{10} shot lifetime, 0.35- μm wavelength, and \$350 /J cost. The requirements depend on achievable fusion gain.
- Beam smoothing techniques are needed for direct drive IFE with DPSSLs. Similar techniques are currently being developed with flashlamp-pumped Nd:glass lasers (Omega and NIF) for direct-drive target experiments.
- R&D is needed in pump diodes, optimized laser architectures, damage thresholds, crystals, coatings, deformable mirrors, and survivable final optics.

Related R&D Activities

- Research areas are directed at higher power DPSSLs, new wavelengths, shorter pulses, and higher brightness.
- DPSSLs are utilized in commercial and military applications such as materials processing, illuminators, remote sensing, and precision machining—all demanding high-to-average power, although relatively low energy per pulse.
- Telecommunications and information industries require low-power, highly reliable diodes, providing strong motivation for development of robust epitaxial semiconductor structures and processing.

Recent Successes

- In support of the Mercury Laser project, high-quality Yb:S-FAP crystals have been grown in a few-centimeter size, high-peak-power diode array tiles (4 kW) have been fabricated, the first multivane gas-cooled head has been constructed, and a 100-J laser design has been completed.

Budget

FY 1996 = \$1.0M; FY 1997 = \$1.9M; FY 1998 = \$2.7M; and FY 1999 = \$4.6M.

Anticipated Contributions Relative to Metrics

Metrics

- Meet driver requirements demand for enhancements in efficiency, reliability, and beam smoothness with reductions in diode cost and 10- to 20-cm crystals.
- Develop and demonstrate IFE laser requirements in a staged series of scientific and engineering prototype test beds.

Near Term <5 years

- Complete design, assembly, and testing of Mercury Laser operating at 1.05 μm ; achieve 10% efficiency with 100 J/pulse, 10-Hz repetitive rate, 2-ns pulse width, 5X diffraction-limited beam quality, and 10^8 shots.
- Perform and validate system-level analysis of achievable beam smoothness on target in power plant scenario for solid-state laser.
- Upgrade Mercury Laser to incorporate average-power frequency conversion, deformable mirror, and beam smoothing technology.
- Develop technology approach for future kilojoule-class DPSSLs.
- Employ Mercury Laser for a broad range of laser-based experiments, in support of IFE, stockpile stewardship, and basic plasma science—enabled by the availability of “cheap shots” on a high-energy laser for the first time.

Midterm ~20 years

- Develop technologies to construct ~4-kJ beam line using low-cost diode arrays ($\$0.50/\text{peak-W}$), operating with 10% efficiency and 10^9 shot lifetime at 0.35- μm wavelength. At least two independent apertures will be integrated to form this beam line, using very high-quality gain media at full size.
- Utilize 4-kJ beam line to drive X-ray source in average-power chamber, testing first-wall survivability, demonstrating beam uniformity, and protecting final optic from X-rays and debris.
- Utilize 4-kJ beam line to create an average power microfusion neutron source for materials studies.
- Identify final optic materials and system designs to withstand megaelectron volt neutrons, gamma rays, and contamination in an IFE power plant.

Long Term >20 years

- Following demonstration of fusion ignition on NIF, survivable first wall and final optic, and functionality of integrated kilojoule-class beam lines, proceed to deployment of megajoule-class facility capable of sustaining repetitive-rated average-power fusion core.
- Achieve minimum diode array cost ($<\$0.07/\text{peak-W}$) based on materials, large sustained market, and full automation of processes.

Proponents' and Critics' Claims

- Proponents might say that solid-state laser technology is naturally matched to inertial confinement fusion target requirements, which is responsible for its preferred status since 1970s. Second-generation solid-state lasers offer the same advantages and flexibility and together with modern technology enhancements will be able to meet future demands of IFE production.
 - Critics might say that diodes are too expensive and unlikely to meet required cost reduction; beam smoothing for direct-drive has not yet been adequately demonstrated for solid-state lasers and particularly for Yb-doped crystalline lasers; and final optic and first wall are at risk of not being survivable in a target chamber.
-

Description

The coupling of intense laser light with plasmas is a very important topic for the applications of high-power lasers. The coupling mechanisms span the gamut from inverse bremsstrahlung and linear mode conversion to many nonlinear optical processes. These include stimulated Raman scattering (SRS) from electron plasma waves, stimulated Brillouin scattering (SBS) from ion sound waves, and laser beam self-focusing and filamentation. These processes depend on laser intensity and produce effects such as changes in the efficiency and location of the absorption and generation of very energetic electrons. Depending on the application, one wishes to either minimize or maximize various nonlinear processes. Laser plasma coupling is an important constraint for inertial fusion. The interaction physics determines the acceptable laser wavelength and beam smoothing and restricts the laser intensity and plasma conditions allowed in the target designs.

Status

Good progress has been made in understanding and controlling the laser plasma coupling for both direct- and indirect-drive inertial fusion.

- The predicted beneficial effects of shorter wavelength laser light have been demonstrated in numerous experiments.
- Laser beam smoothing has been implemented via several different techniques and shown to strongly reduce undesirable plasma effects, such as stimulated scattering and nonlinear beam bending.
- Sophisticated diagnostics have been developed and implemented. For example, electron plasma waves and ion acoustic waves have been simultaneously measured in space and time via Thomson scattering. Likewise, the electron and ion temperatures are directly measured.
- Nonlinear interaction regimes have been identified, such as the saturation of SRS by secondary decay processes and anticorrelation between SBS and SRS.
- New computational models have been developed and run on parallel computers. These include three-dimensional (3-D) codes for laser propagation in plasmas including the effects of filamentation and realistic beam smoothing, 3-D particle-in-cell (PIC) codes, and 3-D hybrid PIC codes to study low-frequency kinetic phenomena. Various reduced descriptions have also been developed to facilitate simulation over disparate time and space scales.
- Reduction of SBS when more than one interaction beam is present in the interaction region.
- Thomson scattering has proven to be an indispensable diagnostic for the study of plasma interactions.

Current Research and Development (R&D)**R&D Goals and Challenges**

- Characterize and understand the nonlinear scaling of the interaction processes with plasma size, intensity, and degree of beam smoothing.
- Develop theoretical and computational models for quantitative simulations of coupling processes on experimental time and space scales.
- Improve understanding of the effects of crossing and overlapped laser beam configurations characteristic of reactor targets.
- Develop new control techniques to increase the options for ICF target design and driver choice.

Related R&D Activities

- The stockpile stewardship of the Department of Energy–Defense Programs (DOE–DP) supports related research on strongly driven laser plasma coupling for advanced applications, such as laser radiography and the generation of high-temperature hohlraums and other X-ray sources.
- DOE supports research on laser plasma accelerators to study some common interaction processes.

Recent Successes

- Laser-induced plasma fluctuations diagnosed in unprecedented detail: simultaneous measurement in space and time of both electron plasma and ion sound waves.
 - Nonlinear beam bending characterized in both experiments and calculations and controlled by laser beam smoothing.
 - Significant reductions of stimulated scattering in hohlraum and gas bag targets demonstrated in Nova experiments using laser beam smoothing via SSD.
 - Development and application of a spectrum of 3-D, massively parallel processing (MPP) codes for modeling laser plasma interactions. These include F3D, a wave propagation code including the effects of filamentation and laser beam smoothing; 3-D PIC codes for fully kinetic phenomena; and 3-D hybrid PIC codes for low-frequency kinetic effects.
 - Characterization and modeling of nonlinear regimes of laser plasma interaction, such as dependences of SRS on ion wave damping, anticorrelations between SBS and SRS, and laser beam spraying by filamentation.
-

Anticipated Contributions Relative to Metrics

Metrics

For direct-drive laser fusion, one desires efficient absorption (>90%) and requires that less than 1% of the laser energy be deposited into high-energy, preheating electrons. These are electrons with an effective temperature >30 keV. For the indirect-drive approach, one desires less than 10% stimulated scattering, less than 10% of the laser energy into preheating electrons, and reproducible laser beam propagation. For fast ignition, one needs reasonable conversion (>50%) of the ultra-intense beam into electrons with energy in the megaelectron-volt range.

Near Term <5 years

In the near term, the emphasis is on

- Testing and modeling the interaction physics in regimes as close as possible to future National Ignition Facility (NIF) and reactor targets
- Improved understanding of control mechanisms, such as the effects of laser beam smoothing
- Testing and understanding effects associated with crossing and overlapped laser beams
- Multiplasmas

Midterm to Long Term >20 years

Develop quantitative, experimentally tested models of the interaction processes to optimize target design, guide the choice of reactor drivers, and identify new applications. This will require the development and routine application of detailed diagnostics for the scattered light, the plasma conditions, and the plasma fluctuations. It will also be necessary to develop improved plasma models for input into advanced codes on parallel computers.

Proponents' and Critics' Claims

Proponents point out the importance of improved understanding of the coupling physics for optimal target design and for more timely and cost-effective achievement of goals, especially as the facilities become larger and more expensive. Small-scale experiments are still the main source of data on the interaction until there will be more time with NIF.

Critics advocate that we avoid deleterious plasma effects on the laser plasma coupling by conservative choices of laser and irradiation conditions and that we engineer our way around any difficulty by experimental iteration.

I-9. PULSED POWER

Description

Pulsed power is a versatile approach to initial fusion that has been used at Sandia National Laboratories (SNL) to (1) drive z-pinch radiation sources for inertial fusion, (2) generate light ion beams for inertial fusion, and (3) provide a repetition-rated pulsed power capability that can be used for z-pinches, ions (light ions/heavy ions), and/or lasers [KrF/diode-pumped solid-state lasers (DPSSLs)] for inertial fusion energy (IFE). The three figures show considerable progress in achieving high X-ray energies with z-pinches, hohlraum temperatures with light-ion-driven targets, and the first commercial application of Repetitive High Energy Pulsed Power (RHEPP) technology for ion beam surface treatment at QM Technologies, Inc.

Status

- Z-pinches have demonstrated phenomenal successes in the last few years, producing very high total X-ray energy (1.8 MJ), peak X-ray power (290 TW), and dynamic hohlraum temperatures (180 eV) with shot-to-shot reproducibility better than 90% and very high efficiency (15% wall plug to X rays).
- Light ions have demonstrated high-power lithium ion beams (10 MeV, 300 kA, 3 TW, 15 ns, 50 kJ, 22-mrad microdivergence, and 0.6-kA/cm² anode ion current density).
- Ion-driven target experiments have demonstrated 63-eV hohlraum temperatures at 1400 TW/g, radiation-dominated and optically thin hohlraums, foam tamping of gold hohlraum walls, radiation smoothing by a foam hohlraum system, and a measured radiation thermal spectrum with no preheat identified.
- Repetition-rated pulsed power has achieved on the RHEPP I facility a proton, C, Xe, or Ar ion beam (500 kV, 20 kA, 60 ns, and 100 cm²) at up to 4 Hz and up to 10-kW average power; RHEPP II has achieved a broad area electron beam (2 MV, 25 kA, 60 ns, and 1000 cm²) at up to 100 Hz and up to 300-kW average power.
- An all solid-state test bed (Dos Lineas) has demonstrated synchronization techniques for parallel modulator systems and continues development of long lifetime magnetic switches and voltage adders at a shot rate exceeding 3×10^6 shots per day.

Current Research and Development (R&D)

R&D Goals and Challenges

- A goal of the z-pinch program is to achieve a reproducible, temporally pulse-shaped hohlraum radiation temperature reaching 225–300 eV (depending on target design concept) with adequate coupling efficiency, symmetry, and preheat levels to drive high-yield (200–1000 MJ) inertial confinement fusion (ICF) capsules.
- Goals for the light ion approach (presently unfunded) are to (1) develop an adequate high brightness, uniform ion source at the science level and (2) study final transport of ion beams in the reactor chamber at the science level.
- Near-term goals for the RHEPP program include reducing the number of magnetic switching stages to reduce driver costs and evaluating next-generation solid-state concepts. Experiments to characterize turn-on of metal/ceramic cathodes in the presence of an external B-field are being planned with the Naval Research Laboratory (NRL) to support its KrF fusion program. If successful, the RHEPP cathode surface is likely to be installed in an amplifier stage at NRL's NIKE laser.

Related R&D Activities

Z-pinch research and RHEPP research is presently funded by Department of Energy–Defense Programs (DOE–DP). The light ion program, supported previously by DOE–DP, is currently unfunded. The ICF program of DOE–DP undertakes important related work in the science-based stockpile stewardship program.

Recent Successes

- The z-pinch program has recently achieved a dynamic hohlraum temperature of 180 eV, demonstrated a long-pulse drive (150-ns current pulse) that produces a short X-ray pulse (sub-10 ns), and imaged kiloelectron-volt radiation from compressed fuel capsules.
- The figure of merit for light ion sources has increased from 0.8 to 7.3 during 1993–1998; a value of 23–50 is needed for IFE. Evidence of self-pinched transport of a proton beam that scales to HIF parameters was recently achieved at NRL [supported by DOE–Office of Energy Research (ER)].
- RHEPP technology moved from a laboratory environment into its first commercial application in 1997 as a driver for a pulsed ion beam surface treatment system at QM Technologies, Inc.

Budget

	FY 1998	FY 1999	Funding
Z-pinches	\$23M	\$29M	DOE–DP
LiF	\$3M	0	DOE–DP
RHEPP	\$2.1M	\$2.2M	DOE–DP (non-ICF)

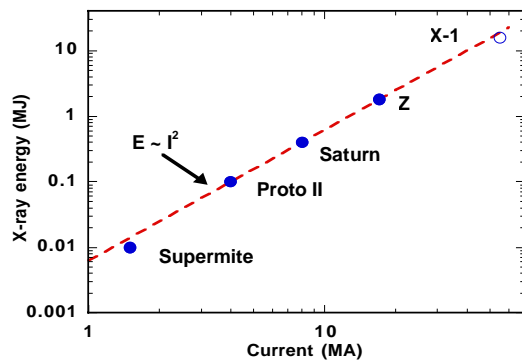

Fig. 1. Z-pinch X-ray power.

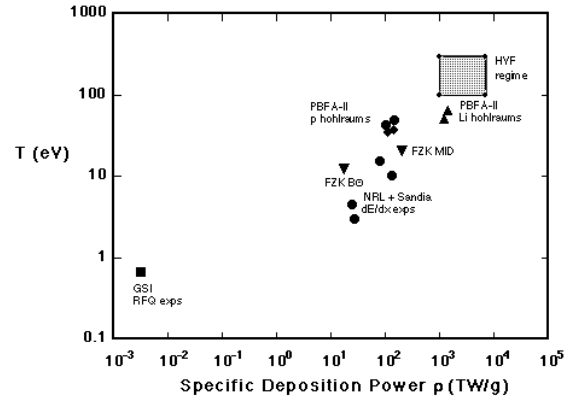

Fig. 2. Lithium-beam-driven hohlraum T.

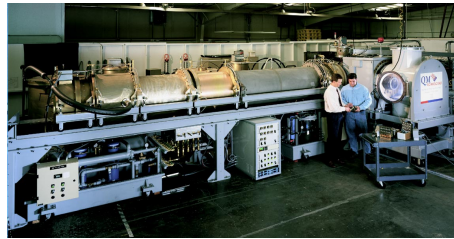

Fig. 3. RHEPP commercial application.

Anticipated Contributions Relative to Metrics

Metrics

- Metrics for z-pinzches are to develop and demonstrate scaling in energy and temperature to get to high yield. For IFE, a repetition-rated z-pinch reactor concept should be developed.
- For light ions for IFE, science-level metrics are to develop an ion source with adequate brightness and beam quality, and understand final beam transport and stability.
- For RHEPP for IFE, unique requirements for various IFE drivers (e.g., ions, KrF, DPSSL, etc.) need to be assessed.

Near Term 5 years

- For z-pinzches, demonstrate energetics, capsule implosions, pulse shape, symmetry, and preheat acceptable for high yield. For IFE, develop a repetition-rated z-pinch reactor concept.
- For ion fusion, develop adequate ion sources and understand final transport and stability.
- For RHEPP, apply to KrF, DPSSL, and HIF.

Midterm 20 years

- For z-pinzches, achieve high yield on X-1 (i.e., 200–1000-MJ yield) and demonstrate key physics requirements for a z-pinch reactor.
- For ion beams, establish the best ion driver scenario (light, heavy, or middle weight) and demonstrate a convincing, scaled, intermediate experiment.
- For RHEPP, develop an operating system for the preferred IFE driver.

Long term >20 years

- Develop an IFE fusion power plant using the high efficiency and low cost of pulsed power.

Proponents' and Critics' Claims

- Proponents claim that z-pinzches offer the fastest, lowest cost path to high yield, which is needed for all IFE scenarios. Critics claim that the concept can not be repetition-rated.
- Proponents claim that ion beams offer the best path to IFE based on efficiency, standoff, repetitive operation, and cost. Critics claim that the LiF ion source is too difficult. Proponents claim that existing ion beam transverse temperatures are within reach of the focusing required for IFE; critics claim that focusing is too difficult.
- Proponents claim that RHEPP technology could be used for all IFE drivers; critics claim the cost will be too high.

I-10. TARGET DESIGN AND SIMULATIONS

Description

Target design/simulation involves the concepts, processes, and tools to obtain a desired goal for a particular driver (e.g., high gain). In inertial confinement fusion (ICF), simulations are usually performed with one-dimensional (1-D) or multidimensional hydrodynamic codes that incorporate the physics in “modules or algorithms.” Inertial fusion target design and simulations are in many ways interdependent because simulations are required to arrive at a given target design. With existing laser systems [later National Ignition Facility (NIF)], designers are able to test and verify their design concepts against experimental results and data. However, subtleties of a design will still depend on the individual designer’s creativity, imagination, and understanding of the complicated interplay in the physics.

Status

In ICF/inertial fusion energy (IFE), a number of potential drivers are considered, with two broad categories of target designs for almost every driver: indirect and direct drive. The majority of the accomplishments in the ICF target area have been a part of the Department of Energy–Defense Programs (DOE–DP) ICF Program, focused on both target categories for laser-driven fusion. To a lesser extent, DOE–DP funded target designs for light ion fusion design, but recently this effort was substantially reduced. There has also been OFES funding for indirect-drive target designs for heavy ion drivers. The most mature target designs are indirect-drive designs proposed for ignition and moderate gain on the NIF. The simulation tools (codes) presently in use are 1-D and two-dimensional (2-D) hydrodynamic codes funded predominately by the DOE–DP. Presently advanced 2-D and three-dimensional (3-D) code development is being funded by the DOE–DP Advanced Strategic Computing Initiative (ASCI) Program and to a much lesser extent the DOE–DP ICF Program.

• Targets Driven with Lasers

Indirect drive for achieving ignition and burn has received the bulk of the DOE–DP ICF funding and is the baseline approach for achieving ignition on the NIF. However, the gain curve based on the NIF point design is too low to produce economic energy with even a 10% efficient laser. There are design concepts that could result in improved gain performance.

Direct-drive laser-driven designs are currently the back-up approach for ignition on the NIF. The DOE–DP activity is centered at the University of Rochester and the Naval Research Laboratory. Experimental data necessary to judge their credibility are now being obtained on the Omega and Nike laser systems. DOE–DP will continue to fund NIF-related ignition target designs in this area. Direct-drive designs are considered a viable potential for IFE, but there is no DOE–DP funding.

Fast ignition is a target design concept in which fuel is first compressed to high density by one driver and then ignited with a very intense injection of energy from another driver, offering the possibility of significantly reduced driver energy, relaxed symmetry, and target fabrication finish requirements. It is primarily a laser approach, although a hybrid where compression is accomplished with ion beams and ignition with a laser is possible. There is limited experimental evidence that can be interpreted as supporting the concept. However, there is no clear evidence that the concept will succeed.

• Targets Driven with Ions

Indirect-drive designs, based on laser research, exist at a variety of heavy ion driver energies that meet the gain requirements of fusion energy. Knowledge about these designs is limited because data supporting heavy ion target interaction experimental are limited. Further experimental work is required, some with international collaboration, to qualify and then improve designs.

Direct Drive. In spherically symmetric 1-D calculations; this approach produces very high gains, but uncertainty remains about the hydrodynamic stability. Recent code improvements may help settle this issue for these implosion designs, but additional target design work will be required.

Current Research and Development (R&D)

R&D Goals and Challenges

Under the DOE–DP, the primary goal is obtaining indirect- and direct-drive ignition on the NIF. DOE–DP IFE-related indirect- and direct-drive target design will continue, but at a low level. Under the DOE–OFES, the program remains focused on the design of heavy ion fusion (HIF) targets but with a growing effort in the area of laser-driven target designs. In these two areas it is increasingly important to begin detailed interactions with the drive and reactor system designers. A level of effort will be continued on the fast ignitor concept. It is a significant scientific challenge due to the computational/theoretical complexities of the problem and the novelty of the laser intensity and pulse length regime required. As part of the DOE–DP ASCI Program new 3-D codes will be developed. The challenges surrounding this effort are many. Software development required for efficient use of massively parallel machines will be important.

Related R&D Activities

- Target design efforts in Europe and Japan on direct-drive laser designs, indirect-drive heavy ion designs, and the fast ignitor.
- Laser radiography in the DOE–DP program, with physics is similar to the fast ignitor concept.
- Code development in the DOE–DP ASCI Program.

Recent Successes

- The completion of the Nova Technical Contract, important for proceeding with NIF.
- Considerable progress in laser beam smoothing.
- New integrated design simulations showing that credible HIF designs can be obtained which meet IFE requirements.
- Development of modern 3-D hydrodynamic codes as part of the DOE–DP ASCI Program.

Budget

- DOE–OFES: FY 1999 = ~\$9M (~\$0.5M for target design).
 - DOE–DP-ICF: ~\$500M including NIF (~\$7–10M for target physics/design-related activities).
-

Anticipated Contributions Relative to Metrics

Metrics

Identification of target designs coupled with reactor systems that meet the requirements for the competitive cost of electricity for commercial power. This will require increased experimental data in a number of critical areas as well as integrated multidimensional design simulations.

Near Term ≤ 5 years

- Important experimental results are expected in the area of direct-drive laser-driven target performance from the Omega and Nike laser systems. Limited planar foil direct-drive experimental data may be available from early NIF operations.
- For indirect-drive with heavy ions, two main areas of continuing work are required. These experiments are needed: (1) laser-driven hohlraums to examine closely coupled (pressure balanced) laser designs similar to those proposed for HIF; (2) in collaboration with European laboratories, ion-driven hohlraums with modest temperatures and pressures; and (3) radiation-driven Rayleigh-Taylor experiments where there is some tamping effect due to low-density foams for investigating the stability of closely coupled targets. The second area of work will be new designs that incorporate information learned from the experiments.
- Important experimental results are expected in the area of indirect-drive laser-driven targets from Omega and the initial operations of the NIF.
- During this time period initial “iterations” with individuals designing reactor and driver will take place. This work will center on arriving at driver-target design concepts that are optimized for overall performance. In addition work will take place to examine the reactor chamber concepts with respect to target outputs. Because each target design concept has subtle, but potentially important differences, with respect to target outputs, this work will be important toward designing and optimizing reactor chamber designs.
- Continued exploration of the fast ignitor concept will require both experimental and theoretical/simulation efforts.
- Improved 2- and 3-D hydrodynamic codes will become available for use in this time period, but these new codes will not be fully validated against experimental data and “benchmark” simulation results. This process will continue beyond the 5-year time period. These codes will be funded entirely by the DOE–DP ASCI.

Midterm ~ 20 years

- Of major importance during this time period will be the experiments to obtain ignition using both indirect- and direct-drive laser-driven targets on the NIF. These experiments will help define the feasibility of the indirect- and direct-drive approaches for fusion energy.
- Once ignition was achieved on the NIF, IFE-relevant target design concepts could be tested during this time period.
- Expected down-selection of IFE drive concepts during this time period will result in a more focused design and iteration cycle for the remaining reactor/driver concepts. Depending on the results from the NIF (and other experiments worldwide), the design and construction of an engineering test facility is a possibility during this time period.
- Use of mature and validated 3-D codes for IFE target designs.

Long Term >20 years

Development of an IFE fusion power plant.

Proponents' and Critics' Claims

Proponents claim that indirect-drive ICF work carried out as part of the DOE–DP effort shows that this approach to IFE is viable.

Currently the criticisms surrounding the use of the ICF concept for fusion energy range from “it will not work at energy scales relevant to fusion applications” to “it will not be possible to be cost competitive with other approaches for producing energy in the future.” With the NIF coming on-line in the near future the community will be in a much better position to answer the first criticism with respect to driver energies. With respect to the second the success of the NIF coupled with continued research in the area of IFE target and reactor design will answer the concerns about cost.

Description

The final optics for laser inertial fusion energy (IFE) (mirrors, diffraction gratings, or refractive wedges) are in the direct line of sight of the target. The final optics must, therefore, be protected from or be able to withstand the damaging effects of X rays, debris, and neutrons emitted by the fusion pulse. Fast-closing shutters (closure time of about 0.1 ms) can stop slow moving debris (such as liquid droplets). A few torr-m of gas, such as krypton or xenon, can stop fast vapor and very small droplets from reaching the final optics and will strongly attenuate X rays, preventing surface damage. Two main alternatives for IFE final optics have been proposed: hot fused silica (gratings or wedges) and grazing incident metal mirrors (GIMMs). Both approaches put a dogleg in the beam path and thus remove optics further upstream from direct line of sight of the target. Final optics made of fused silica would be operated warm (~400°C) to allow continuous annealing of radiation-induced color centers. Predictions are that the fused silica could remain adequately transparent indefinitely under these conditions. GIMMs and grazing incidence liquid metal mirrors (GILMMs) are also expected to be robust (i.e., long lasting) against neutron damage and to some extent X-ray damage. The GILMM flows a self-healing thin film (100 µm thick) of liquid metal such as sodium along a flat inclined plane.

Development and demonstration of an adequate life of final optics is a critical issue for laser IFE. If the lifetime is too short (perhaps less than a year), the change-out costs could be prohibitively high, and the resulting downtime could significantly reduce the plant availability.

Status

- During the past several years there has been some experimentation on fused silica final optics. Neutron and gamma exposure indicate that they are adequate for National Ignition Facility (NIF) operation. Theoretical modeling of the radiation damage mechanisms provides an estimate of the required operating temperature to allow continuous annealing. Because of strong absorption peaks near 240 nm, fused silica is not suitable for use with the KrF laser.
- The idea of GILMM is new and needs analysis and proof-of-principle experiments. The slow-flowing viscous film is predicted to be stable and sufficiently smooth to focus light into a spot of accuracy of ± 0.25 mm at a 30-m distance.
- Shutter development seems like a necessary component of a power plant, but one which is likely to work. It is not a high research and development (R&D) priority for demonstrating the feasibility of laser IFE in the next 5 years.
- Gas stopping of X rays and debris is an important topic for the feasibility of laser IFE. Experiments are needed to prove the concept. The final optics can be destroyed by a single burst of X rays. With enough gas to attenuate X rays (10 torr-m), the laser light can be deflected by the variable index of refraction if the gas is turbulent. In the case of xenon gas, the index of refraction is enhanced at 1/4-µm light due to the presence of a resonance for two photons simultaneously interacting. The presence of turbulent gas can prevent focusing of the light to ± 0.25 mm at 30 m just like a star “twinkling.” Experiments are needed to prove the concept of gas protection of optics.

Current Research and Development**R&D Goals and Challenges**

- Determine feasibility of fused silica or other optical materials for gratings or wedges.
- Identify and acquire attractive optical materials for radiation testing as potential final optics.
- Develop Monte Carlo atomic damage models for candidate final optic materials.
- Develop model to predict optical effects of megaelectron volts of gamma radiation to suggest final optic candidates.
- Conduct irradiation experiments at LANSCE to evaluate radiation hardness.
- Analyze run results; evaluate optical and mechanical properties to identify suitable final optic material.
- Determine feasibility of GILMM concept. Currently, analysis and design of a GILMM experiment is under way and needs to be continued. A thorough survey of literature in related film flow fields needs to be carried out. Low-cost but fairly sophisticated experiments (<\$100,000 in hardware) and about a full-time equivalent (\$200K/year) over several years should be adequate to prove or disqualify the idea.

Related R&D Activities

- Radiation damage modeling for first-wall materials will be applicable to final optics.
- Some promising work was carried out at Lawrence Livermore National Laboratory (LLNL) on laser light propagation through gas.

Recent Successes

- Conceptual design of final optics systems.
- Modeling of damage mechanism in fused silica and prediction of high-temperature annealing.

Budget

Requires ~\$800K/year for optical material R&D tasks and ~\$200K/year for GILMM research.

Anticipated Contributions Relative to Metrics

Metrics

Metrics for final optics include (1) the ability to focus beams to the required spot size from a distance compatible with long-life operation, (2) the ability to operate at a reasonably high laser beam energy fluence (J/cm^2), and (3) acceptable operating life before required replacement or refurbishment. Typical values for these metrics would be the ability to focus to a few-millimeters spot size (direct drive targets) from greater than 20 m, ability to operate with a laser fluence of a few to $10 \text{ J}/\text{cm}^2$ (equivalent normal incident), and lifetime of at least 6 months to a year unless a rapid, remote replacement scheme can be devised.

- For GILMM, can the surface over sizes of about 1 m be sufficiently smooth and controlled? Can the surface recover from prior shots at 6 Hz or so pulse rate?
- For all optics systems, can adequate performance be maintained after months of accumulated radiation damage?

Near Term <5 years

- Experiments in the first years should determine if sufficiently smooth and controlled liquid surfaces can be achieved and maintained on GILMM of sizes of 10 cm or so. Testing high-energy and repetitive pulses of $10 \text{ J}/\text{cm}^2$ (over a small area) would be the next step. The GILMM apparatus would be built and taken to the powerful lasers for testing.
- Experiments in the next few years, possibly next year at the Naval Research Laboratory (NRL), might prove that gas attenuation of X rays works and laser light passage through the gas is possible. If laser light will not propagate through enough gas to allow optics protection, a backup idea is that the gas is held as a low-density fog of droplets. The droplet density is so low that 90% of the laser light passes on to the target, but by the time the X rays return from the target, the droplets have vaporized and formed a uniform gas that can stop X rays. If necessary, this idea could be experimentally verified.
- Additional radiation damage testing of candidate optical material will begin in the near term using LANSCE. Analysis of previously irradiated samples will also be completed.
- Radiation damage modeling effort will be accelerated.

Midterm ~20 years

- For GIMM, if tests were successful at modest sizes of ~10 cm on a side, then scale up to full size and test the optics, perhaps in facilities such as the Integrated Research Experiment (IRE).
- For refractive or diffractive optics, scale up to full-size components and conduct single-shot testing on facilities such as NIF at the appropriate laser fluence.
- Test final optics concepts in an Equipment Test Facility (ETF) at prototypical fusion plant conditions.

Long Term >20 years

- Integrate final optics systems in a demonstration power plant.

Proponents' and Critics' Claims

Proponents claim that protection schemes and damage management processes currently proposed provide a credible story that adequate performance of a final focus system for laser IFE can be developed and implemented. The availability of various design approaches and possible materials and the ability to operate with a large standoff increase the likelihood that an attractive solution can be developed.

Critics claim that this is a showstopper issue for IFE. They point out the great difficulty of protecting optics from X rays and debris in current and planned inertial confinement fusion facilities (Nova, Omega, NIF) even at extremely low shot rates (several per day). They doubt that schemes to prevent contamination of final optics by vaporized target material and possibly by chamber wall materials can be 100% effective, and any contamination will lead to catastrophic failure for subsequent pulses. They suspect that frequent replacement will be required and result in unacceptably high cost of electricity.

I-12. LASER-DRIVEN NEUTRON SOURCES

Description

Modern fast-pulse, high-intensity lasers have the potential to drive low-cost, deuterium-tritium (D-T) point neutron sources for fusion materials testing at high flux/fluence. Such a neutron source would partially fill the void in developing materials for fusion without a high-flux (and high-cost) volumetric fusion neutron source. Compared with conventional beam-target neutron sources, the small source volumes and heat removal by sacrificial vaporization could provide a high-flux source of 14-MeV neutrons at close-coupled, microtest specimens of characteristic dimensions ~ 1 mm at modest cost. In particular, a laser-driven target with ~ 100 J to 1 kJ/pulse at 10 to 100 Hz (i.e., ~ 10 kW average power) and laser irradiances in the range $I\lambda^2 \cong 10^{17}$ to 10^{20} W- $\mu\text{m}^2/\text{cm}^2$ could produce primary, uncollided, 14-MeV neutron fluxes at the test specimen in the 10^{14} to 10^{15} neutron- $\text{cm}^{-2}/\text{s}^{-2}$ range (i.e., equivalent neutron wall loadings of ~ 2 to 20 MW/ m^2). Irradiation volumes would be ~ 1 cm^3 , and the total facility cost would likely be less than \$100M.

The figure shows a conceptual design of such a laser-driven neutron source facility. Three distinct target concepts are presently under evaluation—a hot ion, a solid beam-target concept, an exploding-pusher target concept, and a cluster-ion gas target concept. For the first two designs, neutron-producing targets of a few tens of micrometers in diameter would be mounted, as shown, ~ 1 to 10 cm apart on a continuous foil strip, which moves each target into the firing position at speeds of ~ 0.1 to 10 m/s. A sacrificial foil debris shield moving with the targets protects the material test specimen matrix, which is coupled as closely as running clearances permit.

Relative to other candidate neutron sources, both beam-target and volumetric plasma-based, the laser-driven concepts could provide high 14-MeV neutron fluxes at an order of magnitude lower cost. This is a consequence of the high laser intensities, low total fusion power, heat removal by sacrificial vaporization rather than by steady-state liquid cooling, and of the opportunity to close-couple irradiation specimens. This offers the possibility of a near-term realization of a high flux/fluence neutron test facility for fusion material research with modest capital outlay.

Status

The last decade has witnessed an explosion in the field of short-pulse, high-intensity lasers. Pulse lengths have reduced from tens of picoseconds in the mid-1980s to state-of-the-art ~ 10 fs today. Second, the ability to generate light pulses that are 3 orders of magnitude shorter means that for the same energy and same approximate cost, intensities have increased by the same factor. Thus today intensities of 10^{18} W/ cm^2 are routinely available from tabletop lasers, and systems capable of $\sim 10^{21}$ W/ cm^2 are now starting to come on-line. In particular, access to high-temperature states of matter capable of thermonuclear fusion and/or the efficient production of hot ions for beam-target fusion is now within reach using small-scale, benchtop lasers.

Initial experimental results have been obtained using a 0.1-J, 30-fs laser at an intensity of 2×10^{17} W/ cm^2 incident on an unoptimized, atomic cluster, deuterium gas jet target; $\sim 10^5$ D-D neutrons were measured (T. Dittmire et al., *Nature*, to be published, 1999).

Initial one-dimensional modeling of laser-plasma interactions in extrapolated, production-level, neutron-producing targets has been performed, and neutron fluxes of $\sim 10^{14}$ to 10^{15} neutron- $\text{cm}^{-2}/\text{s}^{-2}$ were indicated (L. J. Perkins et al., Lawrence Livermore National Laboratory, Report UCRL-JC-132334, submitted to *Nucl. Fusion*, 1999).

Current Research and Development (R&D)

R&D Goals and Challenges

- Quantitative experimental data on the interaction of fast-pulse, high-intensity lasers with targets, particularly the mechanisms for high-efficiency, fast ion production from both solid deuterated targets and atomic cluster targets.
- Computational modeling with particle-in-cell and hydrodynamic codes and experiments with candidate targets to project neutron yields and fluxes attainable with affordable laser energies of ~ 100 J to ~ 1 kJ and repetition rates of ~ 10 to 100 Hz (i.e., average power levels of ~ 10 kW).
- Engineering designs of practical laser-target systems for the standoff and protection of close-coupled micromaterials specimens.
- A materials science/computational effort to couple the evaluation of postirradiation, microspecimen assays to multiscale, predictive modeling codes.
- Conceptual engineering design and costing of a production-level, irradiation test facility.

Related R&D Activities

- The Department of Energy–Defense Programs stockpile stewardship activities support many related activities in the field of high-intensity lasers and plasma interactions.
- Because of the introduction of laser pulse compression by chirped-pulse amplification, short-pulse, high-intensity lasers at the $\sim 10^{18}$ to 10^{21} W/ cm^2 intensity level are becoming common worldwide.

Budget

A successful program will require outlays of the following order:

- Near term, 1–3 years: \sim \$600K/year for experiments, modeling, and design studies.
 - Midterm, 3–6 years: \sim \$6M/year for a proof-of-principle (PoP) facility (repetition-rate laser and deuterium targets).
 - Longer term, >6 years: \sim \$25M/year for a production-level irradiation facility ($<$ \$100M facility cost plus scientific program).
-

Anticipated Contributions Relative to Metrics

Metrics

- Flux at test specimen of 10^{14} to 10^{15} neutron·cm⁻²/s⁻² (equivalent neutron wall loadings of ~2 to 20 MW/m²).
- Production-level irradiation facility cost <\$100M.
- Test specimen size of ~0.1 to 1 mm in a temperature-controlled specimen matrix of ~1-cm³ volume.
- Cumulative neutron fluence at the test specimens of ≤20 MW-year/m² (~200 dpa).
- Repetition-rate 100-J to 1-kJ laser operation at ~10 to 100 Hz with annual capacity factors of ~90%.
- Facility tritium inventory <13 g (qualifies as a Class III facility).

Near Term ≤5 years

- Definitive experimental data on the conversion of laser energy to fast ion energy with high efficiency and optimization of the laser-target conditions.
- Definitive computational modeling results for a range of target candidates that demonstrate the attainability of neutron fluxes of 10^{14} to 10^{15} neutron·cm²/s for laser energies of ~100 J to ~1 kJ at ~10 to 100 Hz.
- Engineering design of a PoP facility (repetition-rate lasers at the 100-J level with deuterium targets with facility costs of ≤\$15M). Initial construction of this facility.
- A conceptual engineering design of a production-level, irradiation test facility to demonstrate facility costs of ≤\$100M.
- Establishment of a parallel materials science/computational effort to couple the evaluation of postirradiation, microspecimen assays to multiscale, predictive modeling codes.

Midterm ~5–20 years

- Operation of a PoP facility with repetition-rate lasers at the 100-J to 1-kJ level and deuterium targets. Demonstration of plasma conditions and neutron yields that would extrapolate to fluxes of 10^{14} to 10^{15} neutron·cm⁻²/s⁻² under equivalent D-T conditions.
- Engineering design of a production-level, irradiation test facility with attention to laser system, target design, tritium inventory, hot cells, and conventional facilities, for a facility cost of ≤\$100M. Construction of such facility.
- Operation of the irradiation test facility and end-of-life fluence accumulation for a variety of candidate fusion materials.

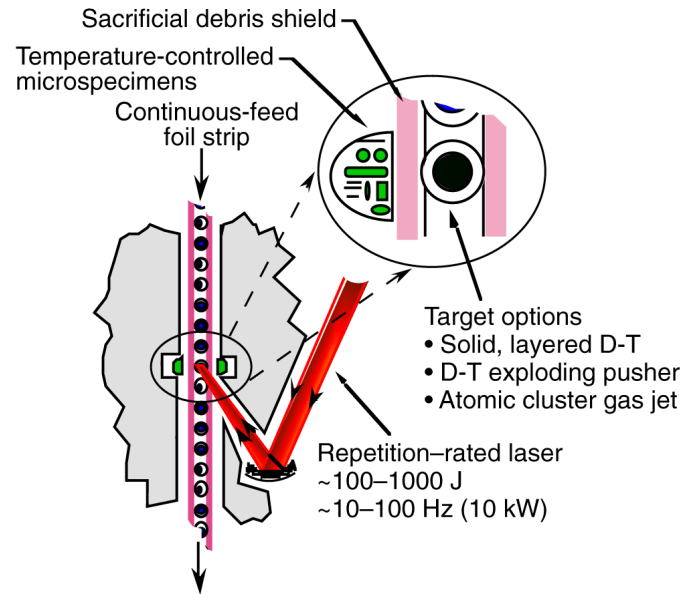

Schematic of a laser-driven neutron source. The first of the three target options are shown.

Proponents' and Critics' Claims

Proponents claim the following:

- Because of the very small source volumes and low fusion power, this concept can yield a high flux/fluence neutron test facility at an order-of-magnitude lower cost than any comparable facility.
- Given the nature of our cost-constrained fusion program, a facility based on this concept may be the only realistic way of obtaining high fluence, 14-MeV neutron damage data for fusion materials in the foreseeable future.

Critics may use these arguments:

- The small test specimen sizes (~1 mm) and small irradiation volumes (≤1 cm³) will be of limited use to the fusion materials program. In particular, heterogeneous systems (e.g., welds) cannot be tested.
 - There is a difference between the damage characteristics of a pulsed inertial fusion energy reactor and a steady-state magnetic fusion energy (MFE) reactor at the same accumulated fluence. Consequently, there is a minimum pulse repetition rate at which this facility will be of use to the MFE materials community.
-

C.4 PLASMA AND FUSION TECHNOLOGIES

Plasma Technologies

Technologies have been developed for producing and handling plasmas for 100 years or so—longer if one considers flames. In the early days temperatures were generally less than the million degrees (100 eV) needed for various arcs. Key technologies that have allowed the development of effective plasma applications include

- high-vacuum systems and wall cleaning techniques;
- the use of magnetic and electric fields to contain and control plasmas;
- plasma-facing materials to handle ion and neutral particle bombardment and heat from the plasma;
- methods for heating plasmas; initially, dc or ac ohmic heating by directly driven currents in the plasma; later by electromagnetic waves—low frequency, radio frequency, microwaves, and particle beams; most recently by lasers radiation; and
- methods for diagnosing and controlling plasmas.

Fusion Technologies

The fusion program, started in a large way in the 1940s and 1950s, built upon the earlier work and then pushed the frontiers of the technologies dramatically, because of its far greater demands for high temperature (100 million degrees or more) and pressure. The most stringent goals of the program are set, generally, by the needs for fusion power plants, and these are captured in the equation for the net electric power produced by the plant.

$$P_{\text{net}} = [(f_{\text{bl}} \cdot f_{\text{te}}) \cdot P_{\text{fus}} - P_{\text{rec}}] .$$

Nuclear
technologies

Plasma
science

Plasma
technology

Balance
of plant

P_{net} is the net electric power, f_{bl} is the exothermic energy gain in the breeding blanket, f_{te} is the thermal to electric conversion efficiency, P_{fus} is the fusion power, and P_{rec} is the electric power recirculated to run the plant.

The plasma science enters mainly in the production of fusion power in the plasma:

- **In the magnetic fusion case**, the power is proportional approximately to plasma volume $\langle \beta^2 \rangle B^4$, where β (beta) is the ratio of the plasma pressure to the magnetic pressure and B is the average magnetic field in the plasma.

Of crucial importance is the rate of transport of heat from the plasma, and much of the research is aimed at optimizing the confinement of plasma while achieving high beta and sustaining a clean plasma. Technologies are needed to heat (T-2, T-3), fuel (T-4), diagnose (S-13), and control the plasmas.

- **In the inertial fusion case**, the energy per pellet is the product of the driver energy reaching the pellet (E_D) times the pellet gain (G). The power is that energy times the pellet repetition rate f_{rep} . The design of the pellet and of the pellet-driver power interface is a central part of the research. Low-cost pellet production (T-17), launching, and tracking systems (T-18) are required.

The recirculating power consists of two parts: the power recirculated to operate the fusion device and its plasma and the conventional balance of plant, cooling pump power, instrumentation and controls, and air conditioning.

- **In the magnetic fusion case**, the fusion device requires power mainly for the magnets (generally superconducting) and their cooling (T-1), for plasma heating and current drive (T-2, T-3), and for fueling and exhaust gas handling systems (T-4).

- **In the inertial fusion case**, the fusion device requires power mainly for the driver system (I-5, I-6, I-7, I-9), for the pellet factory (T-17) and pellet injection (T-18), and the target chamber and fuel recycling systems. Fusion science also enters into the design and operation of the heating and fueling systems.

Impurities. A principle issue for both systems is maintaining a clean system. In the magnetic fusion case, this means limiting the concentration of nonhydrogenic materials (impurities) in the plasma. For a given plasma pressure the dilution of the deuterium-tritium (D-T) fuel by impurities reduces the fusion power. A magnetic divertor (T-5) is proposed to divert the particles and most of the heat to a region where they can be handled. Materials for the walls are needed to handle the residual particle and heat bombardment (T-6, T-7). In the inertial fusion case, the requirement is to clear the chamber sufficiently, between pellets compressions, to not interfere with the next firing. Both liquid metal (T-15) and dry (T-16) walls are considered as ways of handling the heat, momentum, and particle bombardment.

Nuclear technologies. These are (1) the breeding blanket/shield (T-8) and the material wall (T-7, T-9, T-15, T-16) that faces the plasma handle the bulk of the neutron energy, heat the cooling fluid for electricity generation, and protect external equipment for the neutrons; and (2) the tritium plant (T-11) and the equipment for maintenance and radioactive materials handling (T-12).

Materials. The development of radiation-resistant materials is an important part of fusion energy research and development (T-9). Good progress has been made in understanding the materials science of optimizing materials to handle the intense flux of 14-MeV neutrons generated in the D-T plasma. There is also a good understanding of which elements are preferred for making these materials, in regard to minimizing induced radioactivity. However, more work is needed to develop and demonstrate materials with the ability to handle 14-MeV neutrons, a high flux ($\geq 3 \text{ MW/m}^2$), and a high fluence ($\geq 15 \text{ MW}\cdot\text{y/m}^2$). In particular, 14-MeV neutron sources are required for materials testing and qualification (T-10, M-12, M-19, I-12). Good progress has also been made in developing and testing materials to act as the interface with the plasma (T-6).

Design studies. The requirements for technologies, deriving from the designs of current experiments and of future reference facilities (M-16, M-17, M-18, T-20), are used to set the near- and long-term development goals, respectively. For example, economic studies of complete power plant systems were used to determine minimum performance, lifetime, and reliability requirements for components such as the flux and fluence for radiation-resistant materials, shown above.

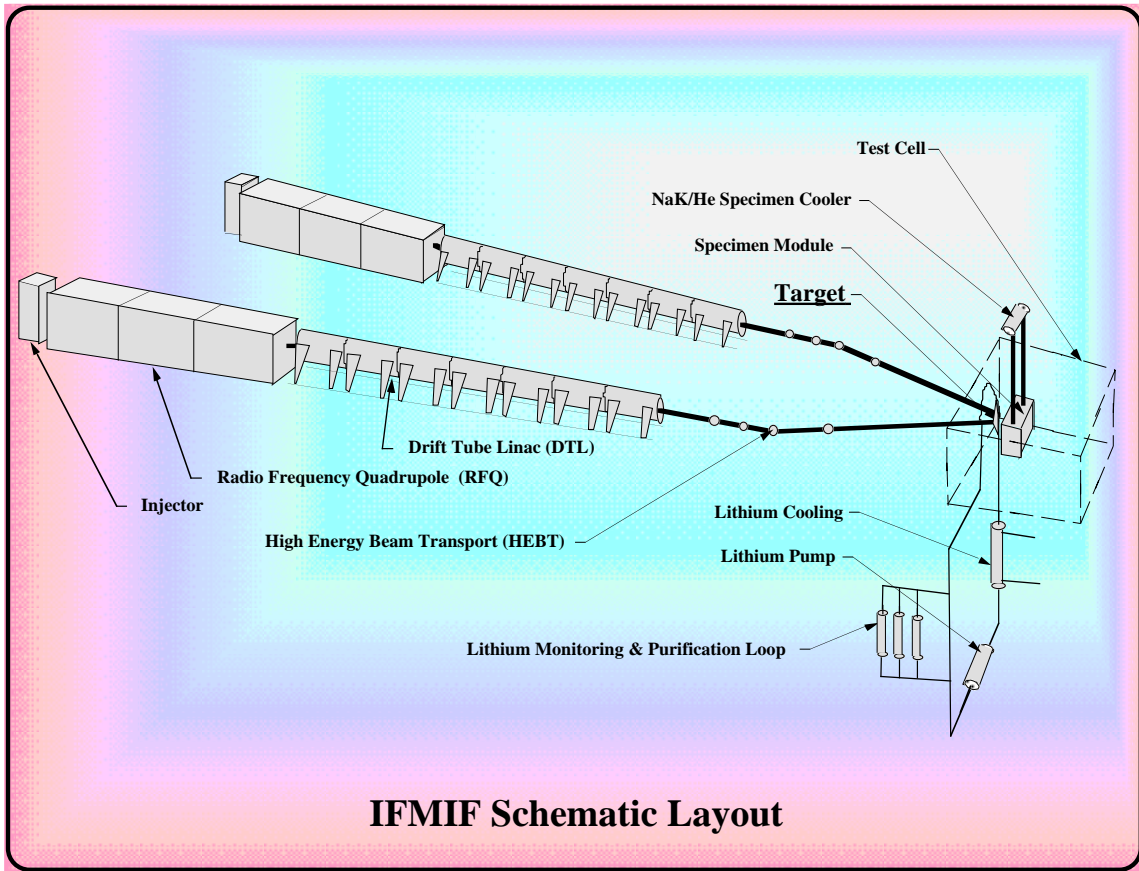

T-1. SUPERCONDUCTIVITY

Description

- Most design concepts for magnetic fusion energy (MFE) power-producing commercial reactors depend on superconducting magnets for efficient production of magnetic fields. Many magnetic configurations rely on both dc and pulsed magnetic fields for plasma confinement, initiation, ohmic heating, inductive current drive, plasma shaping, equilibrium, and stability control. Inertial confinement fusion (ICF) may also utilize magnetic fields for beam focusing quadrupole fields in the heavy ion driver (HID) concept and for protecting the first wall from ionized debris. The attraction of superconductivity is the ability to carry very high current density with zero dc power dissipation. Superconductors dissipate energy in a changing magnetic field, but power losses, including refrigeration power to keep the magnets in the superconducting state (typically 4–8 K temperature range), are very small compared with power for resistive magnets. This advantage grows with increasing magnetic fields and field volume.
- Superconducting magnets require advanced engineering design and technology, advanced materials, and supporting cryogenic technology. The standard conductor design for all new device designs is the Cable-in-Conduit-Conductor (CICC), which is comprised of a multistage superconducting cable enclosed in a tube or conduit made from a high-strength structural alloy and cooled by forced flow of supercritical helium.
- Presently only the low-temperature superconductors (LTSs) with critical temperatures of ~10 K for the ductile alloy niobium titanium (NbTi) or ~18 K for the brittle compound niobium-tin (Nb₃Sn) are used or planned for future devices. The newer high-temperature superconductors (HTSs) with critical temperatures on the order of order 90 K and above are expected to be used primarily for low-loss magnet current leads in the short term. Longer term application of HTS depends on progress in development of materials in long lengths with significantly improved critical current densities for use in magnetic fields of 12–20 T at higher operating temperatures than typical LTSs and with similar cost.

Status

- The NbTi superconducting alloys are commercially available. NbTi is used in Tore Supra (France), in the former T-7 (Russia), presently operated as HT-7 (PRC). MFTF-B used mostly NbTi. The Large Coil Program used five NbTi coils and one Nb₃Sn coil. The Large Helical Device (LHD) has just begun operation in Japan using all NbTi superconducting magnets. The Stellarator Wendelstein 7-X is presently under construction using NbTi CICC with a co-extruded aluminum conduit.
- K-STAR is being designed using Nb₃Sn CICC. The Nb₃Sn compounds meeting fusion program specifications have recently been developed under the International Thermonuclear Experimental Reactor (ITER) research and development (R&D) program. The largest production in the world (~30 tons) was done for the ITER CS and TF model coils to be tested in 1999. About 60 tons of the high-strength superalloy Incoloy Alloy 908 was produced in the form of extruded conduit for the ITER model coils.
- A superconducting floating ring that uses Nb₃Sn for the Levitated Dipole Experiment (LDX) is under construction.

Current Research and Development

R&D Goals and Challenges

- Increase superconductor current density at high magnetic field with very low magnetic hysteresis loss. Present best performance is noncopper J_c ~ 1000 A/mm², ±3 T hysteresis loss ~400 mJ/cm³, or J_c ~ 800 A/mm², ±3 T hysteresis loss <200 mJ/cm³.
- Reduce cost of superconducting wire.
- Develop high-strength structural alloys for cryogenic operation as conductor conduit and magnet case and intercoil structure. Conduit material must withstand HTS reaction heat treatment.
- Develop low ac loss, low dc resistance, high-stability conductor joints.
- Develop HTS for fusion applications taking advantage of very high critical magnetic field and high critical temperature. HTS cost must become comparable to at least Nb₃Sn cost with better performance.
- Improve theoretical understanding of ramp rate limitation phenomena, with empirical correlation and large-scale pulsed coil test verification (CSMC test).
- Develop radiation-resistant magnet electrical insulation to allow higher nuclear heating. Electrical insulation damage is the present lifetime limitation of a burning plasma experiment or reactor designs.

Related R&D Activities

- Measurement of ac losses in multikiloampere, multistage cables under large cycle field sweeps with transport current.
- Development of Incoloy Alloy 908 in industry with modified composition to reduce sensitivity to strain accelerated grain boundary oxidation (SAGBO).
- Laboratory experiments and theory to develop Superconductor Laced Copper Conductors (SLCCs) using a small amount of superconductor laced with copper for reduced cost conductors with high stability and quench protection.
- Laboratory measurement of ac losses in HTS under fusion-relevant dc and pulsed field and current conditions.

Recent Successes

The ITER CS Model Coil (CSMC) is the most powerful pulsed superconducting magnet in the world with a peak field of 13 T, 50-kA operating current, 650-MJ stored energy, and design pulse rate of up to 2 T/s.

Budget

FY 1998 = \$13.0M, FY 1999 = \$6.85M including both R&D and design funding. The bulk of FY 1998 and FY 1999 funding was for ITER R&D tasks, primarily for CSMC fabrication. More than two-thirds of funding went to industry in both fiscal years. FY 1999 includes \$100K total magnet base program funding.

Anticipated Contributions Relative to Metrics

Metrics

For MCF: Based on the ITER design, superconducting magnet technology should be able to

- generate a toroidal field of 5.68 T at the plasma major radius of 8.14 m;
- induce and drive a 21-MA plasma current;
- inductively sustain a 1000-s flattop under ignited conditions with a 2200-s nominal repetition time;
- operate reliably with no magnet quench under any normal operation scenario including plasma disruption;
- operate for 50,000 total pulses, including 15,000 disruptions in physics phase and 35,000 in technology phase;
- transfer superconductor technology to alternate concept MCF devices (e.g., floating dipoles, stellarators, compact torus).

For inertial fusion energy (IFE): Develop high current density, low-cost superconducting quadrupole magnets for HID.

Near Term ≤ 5 years

- The ITER magnet R&D program fulfilled all specifications required to proceed with construction of the device. Test of the CSMC will demonstrate that 50-kA class superconductors are available to operate in pulsed fields to 13 T. The world's first large-scale production of Nb₃Sn superconducting strand and structural conduit alloy demonstrates the industrial capability. The superconducting magnet technology is available for any MCF device.
- R&D efforts should focus on reducing materials costs and innovative magnet and component design to reduce overall fabrication and operating costs.
- Superconductor development for fusion should be coordinated with HEP applications.
- Transfer large-scale superconductor technology to other power applications (e.g., power transmission, transformers, fault current limiters, energy storage, and power system stabilization).
- Focus on introduction of HTS materials for fusion applications.

For IFE-HID: Develop low-cost, high current density NbTi quadrupole magnets with compact design and small-gap warm bore tube.

Midterm ~ 20 years

- Focus on materials development including superconductors, structural materials, and radiation-resistant insulating materials.
- Transition HTS to working fusion devices to demonstrate enhanced physics performance for high field magnets (up to ~ 20 T) with reduced operating costs at higher temperature (20–80 K).
- Improve performance and costs of cryogenic refrigeration systems.

Long Term > 20 years

Deliver superconducting magnet systems for any reactor-grade fusion device including MCF and HID for IFE.

Proponents' and Critics' Claims

Proponents

- Superconductivity is required for any commercially attractive fusion plant with low recirculating power or for any steady-state, long-pulse, or reactor-relevant burning plasma experiment.
- Superconductors can operate at very high current density with overall magnet current. Relevant structural materials can operate at 4–10 K with up to twice the stress levels of room temperature operation.
- HTSs can retain the benefits of superconducting magnets—drastically reducing refrigerator costs, while extending high field performance up to 20–25 T, limited only by structure.

Critics

- Superconducting technology is expensive and requires higher initial capital costs than resistive magnets.
 - The cryostat complicates the machine design, lowers current density, and complicates plasma access.
 - Long-term reliability of superconducting magnet and refrigeration systems has a limited database.
 - The U.S. program has no new machine on the horizon that requires superconducting magnet technology.
 - HTS is even more expensive than LTS with little chance of matching NbTi costs; it has similar fabrication problems as Nb₃Sn (high-temperature reaction, brittle material) and is far less developed than any LTS wire.
-

T-2. ELECTROMAGNETIC HEATING AND CURRENT DRIVE

Description

To produce energy, fusion plasmas must first be raised to ion temperatures in the tens of kiloelectron volt range. The purpose of the heating systems is to do this. In addition, heating systems can drive current and add momentum to the plasma, both of which are necessary for very long pulse or steady-state operation. There are several electromagnetic (EM) radiation heating and current drive systems, all of which operate by injecting radio-frequency (rf) waves into the plasma: electron cyclotron (EC) in the 30- to 250-GHz frequency range, ion cyclotron (IC) in the 10- to 200-MHz range, and lower hybrid (LH) in the 2- to 10-GHz range. All of these EM systems can heat and drive current.

Status

EC—Systems using 0.5 to 1.0 MW steady-state sources at 60 to 140 GHz have been used to heat and drive current in several major devices. Development of 1-MW steady-state sources at 110 GHz is nearing completion, and development of 2-MW sources at 110 GHz and 1 MW sources at 170 GHz is underway. Heating and power deposition is well understood. Efficiency (power to plasma/power from mains) $\approx 30\%$.

IC—Systems delivering 1 to 2 MW per antenna are operating on many fusion experiments. Both ion and electron heating have been demonstrated; physics understanding appears good in most cases, but not in all. Some current drive experiments have been done, but full noninductive current drive was not demonstrated; efficiency $\approx 60\%$.

LH—Heating and current drive system was demonstrated in several experiments. This system exhibits best efficiency for current drive (most amps driven per watt to the plasma); efficiency $\approx 40\%$.

Current Research and Development (R&D)

R&D Goals and Challenges

The United States has technology R&D programs in EC and IC but not in LH at present.

• EC

- Develop multimewatt, steady-state sources in the 110- to 200-GHz range.
- Improve source efficiency from present 30% to $>75\%$.
- Develop and test vacuum windows that can transmit 3 MW of power.
- Develop tunable EC systems (gyrotrons) and launchers for maximum flexibility.

• IC

- Develop and test launchers that can deliver power to the plasma utilizing small amount of port/wall space (present capability is $\leq 1 \text{ kW/cm}^2$, desire 3–4 kW/cm^2).
- Demonstrate high-power steady-state current drive.
- Validate launcher designs that can operate in a reactorlike environment.

• LH

- Design and test a LH launcher that can exist in a reactor environment.
- Note that present LH launchers must be very close to the plasma to couple power; survival of such a launcher in a reactor is unlikely.

Related R&D Activities

EC—Major programs are developing high-power steady-state sources and windows at 110 to 170 GHz in Japan, Europe, and Russia. The Large Helical Device (LHD) (Japan) requires 168-GHz, 1-MW steady-state sources, so development probability is high. Diamond windows capable of transmitting $>1 \text{ MW}$ have been developed. Spinoffs in industrial heating and radar enhance the R&D program.

IC—IC is used on many fusion experiments worldwide. Technology development is mostly associated with fusion experiments: Joint European Torus (JET), Tore Supra, and ASDEX-U (Europe); and LHD and JT-60U (Japan). Major nonfusion R&D in this frequency range is carried out for plasma processing of semiconductors.

LH—Few R&D efforts are under way in Europe and Japan. The system on JT-60U is operational.

Recent Successes

EC—A diamond vacuum window capable of transmitting 1 MW was developed. A depressed collector gyrotron operated at $>50\%$ efficiency; a 1-MW, 110-GHz gyrotron operated in 0.6-s pulses; and a 1-MW, 170-GHz prototype gyrotron was demonstrated in basic research.

IC—An ITER prototype antenna was tested to operating voltages (in vacuum) of 60 kV.

LH—Both a 1-MW, 8-GHz gyrotron in Europe and high-efficiency klystrons were developed in Japan.

Budget

- FY 1998 = \$0.65M for EC technology R&D (including the ITER R&D tasks); and \$1.4M for IC technology R&D.
- FY 1999 = \$1.0M for EC, and \$1.4M for IC. No U.S. funding for LH technology R&D.

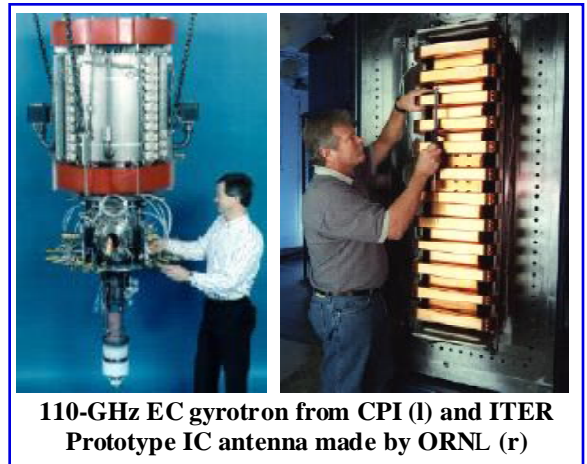

Anticipated Contributions Relative to Metrics

Metrics

Based on results from the ITER design studies, heating systems should be able to

- Deliver up to 100 MW to a reactor-grade plasma.
- Drive significant current (5–10 MA) and be able to dynamically change the current profile.
- Operate with wall plug to plasma efficiencies of 50% or higher.
- Utilize a minimum amount of port/wall space, with a power flux of at least 1 kW/cm²; higher is better.
- Operate in a reactor environment for several years with no major maintenance to components inside the machine vacuum.
- Operate with high reliability.
- Have a capital cost not exceeding \$4/W of power delivered to the plasma.

Near Term <5 to 10 years

The goal is to develop and test high-power launchers and sources (present U.S. programs).

- EC
 - Develop and demonstrate reliable 170-GHz CW gyrotrons at the 1- to 3-MW power level.
 - Develop gyrotrons with >50% efficiency.
 - Develop reliable, low-cost windows capable of greater than 3 MW of power transmission.
 - Develop high-efficiency (>90%) transmission lines that can transmit over 3 MW of power.
- IC
 - Develop highly directional and fast steerable launchers.
 - Develop and test high-power, high-power-density launchers.
 - Develop a fast, automated control system that allows real-time control of current drive directivity while maintaining high heating power to the plasma.

Midterm 10–20 years

The goal is to demonstrate high-power, long-pulse, reliable operation (present U.S. programs).

- EC
 - Improve gyrotron efficiency to greater than 75% by use of a multistage depressed collector.
 - Develop gyrotrons that are tunable in frequency for maximum flexibility.
- IC
 - Demonstrate long-pulse, fully noninductive discharges using IC current drive.
 - Study and understand the interaction between the plasma edge and high-amplitude rf waves near the launcher.

Long Term >20 years

Build reactor-grade components and systems.

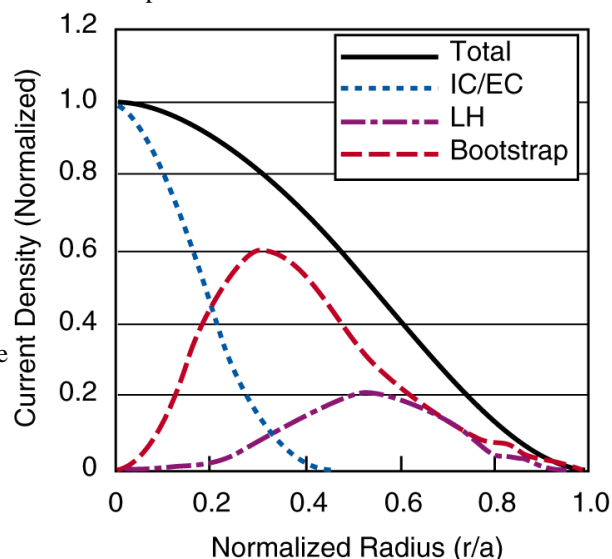

Steady-state current profile with EC or IC for central CD, LH for outer CD, and bootstrap current (current fractions of 6%, 34%, and 60%).

Proponents' and Critics' Claims

Proponents make the following claims:

- **EC** has the highest power flux (≥ 10 kW/cm²) of all the heating systems, allowing small port sizes. The launcher can be located far from the plasma, because waves propagate losslessly in vacuum to the plasma boundary. The physics is well understood. Technology advances (diamond window, depressed collector) are reducing costs rapidly.
- **IC** has the potential to be lowest-cost heating system; it can heat either ions or electrons and change current drive efficiency quickly.
- **LH** has the highest demonstrated current drive efficiency of any heating system. It can drive current in outer regions of plasma to reach advanced-physics-mode, reversed-shear operating regimes.

Critics state these claims:

- **EC** is a high-cost system at present, with relatively low-power sources (~1 MW). It can only operate at single frequency at present.
- **IC** is the lowest power flux of all the heating systems. Survivability of the launcher (at the first-wall location) has not been demonstrated and could be a major problem.
- **LH** requirement for relatively close proximity of the launcher to the plasma is extreme, making survivability of the launcher very difficult.

Description

Neutral beams have found wide applicability in heating and driving current in magnetically confined plasmas. Electrically charged ions are produced in an arc discharge source. These ions are then accelerated to high energies by falling through an electrostatic potential. After acceleration, the now-energetic ions traverse a gas cell, where a portion of them are converted to energetic neutral atoms. After the beam exits the gas cell, the residual ions are removed by magnetic or electrostatic deflection, and the energetic neutrals continue through a duct into the plasma, where they are again ionized and then magnetically confined as they transfer their energy to the bulk plasma through collisions. Before 1995, all of the neutral beam systems used in fusion research produced positive ions of hydrogen isotopes, which picked up an electron through charge exchange while passing through the gas cell to become neutral. While this works well at lower energies, the efficiency of neutralization begins to decline, increasingly rapidly at beam velocities greater than the classical velocity of the hydrogen electron. For deuterium, the efficiency deteriorates above about 80 keV, or 120 keV for tritium. At higher energies, it is much more efficient to produce negative ions and then to collisionally strip the extra electron in the gas cell to produce an energetic neutral.

Status

- Positive-ion-based neutral beams have been the workhorses of most of the world's magnetically confined plasma devices for fusion research. The neutral beam systems of two tokamaks, Tokamak Fusion Test Reactor (TFTR) and JT-60U, have each injected maximum neutral beam power levels of about 40 MW into the confined plasmas. The physics of heating and current drive by neutral beams is straightforward and is well-described by existing codes.
- The first two negative ion neutral beam systems have recently come into operation. The JT-60U system in Naka, Japan, is expected to eventually operate at 500 keV for pulses of up to 10 s with a deliverable neutral power of about 10 MW. Because schedule and budgetary constraints precluded the construction of a test stand for the full negative ion source and its accelerator, the final development has had to be done in the operational beam line mounted on JT-60U in conjunction with the JT-60U schedule. Very significant progress has been made in understanding and correcting problems, and as a result the achievable power, pulse length, and beam quality are improving and may approach or reach the full planned parameters during the 1999–2000 period. The JT-60U has so far operated in pulses of up to 1.9 s at a few megawatts. Recent Doppler shift measurements show that the neutral beam transmitted to the tokamak is essentially monoenergetic at the full-acceleration energy, with essentially no low-energy distribution arising from stripping within the accelerator.
- The second negative ion neutral beam system, located on the Large Helical Device (LHD) near Nagoya, Japan, will supply all of the neutral beam heating power for this large stellarator. This system is designed for operating energies of 125–250 keV. The initial operation appears to have proceeded relatively smoothly, with pulses of a megawatt for several seconds produced.

Current Research and Development (R&D)

R&D Goals and Challenges

- The most pressing immediate goals and challenges involve the two large negative ion systems in Japan. Because they are the first of this advanced technology, they require more time for study, optimization, and modification before they reach the level of maturity that has long characterized positive ion neutral beams. This research and optimization has been under way for about 3 years and will continue.
- Current drive studies using the negative ion neutral beam are under way at JT-60U and indicate that the current drive efficiency is well described by current codes. Experiments can be carried out to see whether this efficiency deteriorates during excitation of strong instabilities such as Toroidal Alfvén Eigenmodes.

Related R&D Activities

- The Japan Atomic Energy Research Institute and the Euratom Laboratory at Caderache, France, are collaborating in experimental work aimed at producing negative ion sources for the International Thermonuclear Experimental Reactor (ITER) with an energy of 1 MeV or more.
- The I. V. Kurchatov Institute in Moscow has an experimental program in plasma neutralizers, which might in principle allow higher neutralization and overall power efficiencies than gas neutralizers.
- The ITER design team has designed negative ion neutral beam line concepts appropriate for the ITER environment and requirements.

Recent Successes

- Almost all of the high heating power results of tokamaks, such as the production of 10.7 MW of fusion power in TFTR, have been driven largely or entirely by positive ion neutral beams.
- The two large negative ion neutral beam systems coming into operation in Japan constitute the vanguard of a new technology that can extend the reach of neutral beams to energies of hundreds of kiloelectron volts to more than a megaelectron volt.

Budget

- Within the United States, the budget is essentially zero, except for personnel exchanges with the Japanese laboratories which benefit both parties.
- The budget within Euratom is probably a few million dollars per year, and within Japan it is considerably more.

Anticipated Contributions Relative to Metrics

Metrics

- The metrics for neutral beams are high system energy efficiency (the ratio of the neutral beam power delivered to the plasma relative to the primary power used to run the complete beam system), high beam energy, high-power capability, long-pulse length capability, and high reliability. Positive ion systems had system power efficiencies of 30–40%; current negative ion systems, when fully optimized, should have power efficiencies of 40% or greater. This should be adequate for a reactor, although improvements would be welcome. Beam energies of 1–2 MeV will be needed for reactors. The JT-60U negative ion systems have delivered beams of a few megawatts at 360 keV. The extrapolation to megaelectron volt levels is expected to be challenging but to be achievable with electrostatic acceleration as has been used for all high-power systems. Pulse lengths of several seconds have been achieved, but these have been limited primarily by thermal constraints imposed by beam line components with low amounts of cooling. Demonstrated high heat transfer technologies are known to allow long-pulse operation on devices that require it. Continuously operating beams will require more sophisticated arrays of cryocondensation panels to maintain the beam line vacuum, because it will be necessary to maintain pumping while some of the panels are isolated and purged of their accumulated hydrogen isotopes.

Near Term ≤ 5 years

- The negative ion systems of JT-60U and LHD will be brought to their full capabilities, driving experiments on these devices. Their operation will provide the experience basis for the design of successor systems using these technologies.
- Design and development for higher energy negative ion systems in the 0.75- to 1.5-MeV range will continue for use on ITER or other future large machines.

Midterm ~ 20 years

- ITER or another new large machine such as JT-60SU (a larger JT-60U) will use high-energy negative ion beam systems for heating and current drive. These systems may use plasma neutralizers, or perhaps photodetachment neutralizers, to reach system power efficiencies of 50–60%. Lower energy positive ion neutral beam systems may be used for rotation control of the outer plasma.

Long Term > 20 years

- With appropriate budgets, it should be practical to build negative ion neutral beam systems suitable for any magnetically confined fusion plasmas so far envisaged in reactor designs.

Proponents' and Critics' Claims

The principal advantages of neutral beams follow:

- The interaction of the beam particles with the plasma is well understood.
- The coupling of the beam to the plasma is relatively insensitive to plasma edge conditions, making it particularly ideal for the experimental development of fusion, during which many different plasma conditions must be explored.
- Because the beam transfers its energy to the plasma through successive two-body collisions rather than complex wave interactions, the technology can be developed completely independently of the device on which it is to be used. The use of high-power test stands can permit a system to be almost mature by the time it is deployed on a fusion device.
- The most complicated parts of the beam line for a reactor will be one to a few tens of meters from the plasma.
- With negative ion neutral beams, heating and current drive can be effective even at the center of a reactor plasma, with suitable system power efficiencies.

These are principal disadvantages of neutral beams:

- The technologies presently under development require large ducts with direct line of sight to the plasma. These serve as leaks through the blanket for fusion neutrons. This loss modestly reduces the power and tritium breeding efficiency of the reactor, and the neutrons damage unshielded insulators and activate components. Accelerators with bends that would remove the need for a direct line of sight have been explored experimentally in the past at Lawrence Berkeley Laboratory and might be suitable for a reactor.
- Neutral beam lines are large, using substantial space near the reactor and may extend the tritium boundary.
- Neutral beam lines, especially negative ion systems, are intrinsically inefficient in their utilization of the gas from which they produce ions. The gas they collect on their cryocondensation pumps will have to be recycled and perhaps purified so that the deuterium and tritium can be reused.

T-4. FUELING AND VACUUM

Description

All fusion devices will require a controlled input of fuel and controlled exhaust of recycled fuel, impurities, and fusion reaction products. Fueling systems control the plasma ion density (level and profile), replenish the fuel burned in the deuterium-tritium (D-T) fusion reaction via core fueling, and establish a flow of hydrogenic ions into the scrape-off layer through edge fueling. Efficient plasma fueling is very important for a practical fusion power source. Inefficient fueling leads to a large tritium throughput, which impacts cost, safety, and tritium self-sufficiency issues. Large torus exhaust gas loads need to be reprocessed, adding to the cost and complexity. Plasma vacuum systems benefit from high wall pumping rates in present generation short-to-moderate pulse length devices. For longer pulse lengths or situations where wall conditioning is not controllable, a plasma exhaust/vacuum system with modest tritium inventory is needed with a capability to exhaust at the specified vacuum level at a mass flow rate equal to the fueling rate.

Status

Plasma fueling with external gas or recycled particles from walls is the oldest and predominant method used in current devices. As devices have grown in size, gas fueling has become less efficient; in both tokamak and helical device experiments, degraded confinement has resulted from excessive edge neutrals. Pellet fueling is an established technology used for core fueling of large contemporary tokamaks and stellarators. Fueling with compact toroids (CTs) is newer with very different technology, physics opportunities, and associated issues. Pellet fueling technology has made good progress as detailed in Table 1. Pellet fueling has been successfully employed to reach and exceed empirical density limits in many tokamak devices. These experiments have shown that pellets provide deeper and significantly more efficient fueling than gas puffing. Despite these successes, issues remain in understanding the fueling and interaction of pellets with hot plasmas. The mass deposition of pellets injected on the low-field-side of tokamaks is not in good agreement with pellet ablation theory. Substantially improved penetration and fueling efficiency is observed with high-field-side injection, but the theory of high-field-side pellet ablation and mass redistribution needs to be developed. Related technologies include small impurity pellets for diagnostic functions and for coating plasma-facing components, liquid hydrogen, high-pressure jets (or low-Z pellets) for plasma disruption mitigation, and components for injecting and transporting inertial fusion energy (IFE) targets to the interception point with the laser or heavy ion driver pulse.

The CT fueling requires forming a high-density plasmoid confined by its own poloidal and (possibly) toroidal magnetic field, accelerating this plasmoid to high velocity, and injecting it through the confining magnetic field into the main plasma. Such plasmoids have been formed at high density and accelerated to the velocities thought to be required for central fueling in toroidal reactors. The CT injector on the STOR-M tokamak has the capability to inject CTs tangentially. Two types of CT accelerators are being developed for fueling applications. The first produces spheromak CTs in a magnetized plasma gun. The second technique produces field reversed configurations (FRCs) by purely inductive methods. Spheromaks contain roughly equal toroidal and poloidal magnetic fields and have moderate betas. The FRCs have small toroidal fields and operate at betas above 50%. Recent experiments in CT fueling have demonstrated its potential for central fueling and the capability for repetitive operation. The CT fueler on the TdeV tokamak has demonstrated nondisruptive fueling for a 1- to 4-T toroidal field.

In the vacuum pumping area, only limited development is ongoing in the United States, primarily in the area of innovative, low mass inventory, cryogenic pumping technology. There is an ongoing Phase I STTR to evaluate compact pumping technologies (snail and pellet cryogenic pump) for possible testing at the Tritium Systems Test Assembly with D-T gas.

Current Research and Development (R&D)

R&D Goals and Challenges

- Develop plasma fueling systems that are capable of providing a reliable, flexible particle source for controlling core plasma density and density gradients at acceptable fueling efficiencies.
- Develop technologies for injection of nonhydrogenic materials for diagnostics and disruption mitigation.
- Explore feasibility of compact, low mass inventory pumping schemes with potentially high impact on reactors.

Related R&D Activities

- Improved plasma pumping system (Los Alamos National Laboratory STTR) for D-T devices.
- Improved fueling and exhaust systems for IFE (fuel capsule design and transport to the ignition vessel).

Recent Successes

- High-field-side launch has improved pellet penetration by a factor of 2 and fueling efficiency by a factor of 4 on ASDEX-U for the same pellet/plasma initial conditions. Favorable ∇B drift deposits more pellet mass near the center.
- Deuterium has been extruded at mass flow rates required for reactors for moderate pulse lengths. With the same technology and smaller nozzles, present large tokamaks can be fueled to steady state.
- Pure tritium and D-T pellets sized for a reactor application (~10 mm) have been extruded.
- CTIX injector on the Davis Diverted Torus demonstrated repetitive injection for 1000 shots at 0.2 Hz.
- CT injection has achieved 2 mg of mass at 40 cm/ μ s in single-shot experiments.
- FRCs with 0.6-mg mass have been formed and injected at 20 cm/ μ s into the TRAP experiment.

Budget

- DOE-OFES for fueling: FY 1998 = \$1050K; FY 1999 = \$900K; and for CTs: FY 1998/1999 = \$470K.

Anticipated Contributions Relative to Metrics

Metrics

The metrics for fueling and pumping systems are sufficient to maintain the specified plasma density profiles and edge conditions at mass throughputs driven by device size, wall condition, and fusion power. This includes understanding the physical principles and scaling of high-field pellet launch physics as well as understanding the physical principles of fueling by dense plasmoids. Flexible fueling systems for ongoing plasma science programs at home and abroad will be developed and provided to the research community.

Near Term ≤ 5 years

In the near term, an understanding of the physics and technology of high-field-side (vertical and inside) pellet launch will be developed. A high-field-side launch system with D-T pellet capability will be implemented on the Joint European Torus (JET). Long-pulse fueling systems will be fielded on the Large Helical Device (LHD) and JT-60SU. CT experiments on a larger toroidal device should be initiated to produce relevant data for designs of future injectors. A prototype disruption mitigation system using hydrogenic jets will be tested on DIII-D. A CT injector is planned for the LHD in Japan. In the inertial fusion area, expertise developed for magnetic fusion fueling will be extended to develop innovative target delivery systems for IFE. Innovative, low inventory, D-T pumping systems (snail and pellet cryogenic pump) will be evaluated at TSTA.

Midterm ~ 20 years

In this period, innovative fueling and exhaust systems will be applied to burning plasma experiments to determine if optimization or innovative operation can make a more attractive IFE/ magnetic fusion energy (MFE) product for the long term. Isotopic fueling will be evaluated experimentally to quantify leverage on tritium fueling efficiency, burn fraction, and extrapolated tritium breeding ratio.

Long Term $>20+$ years

Plasma fueling and exhaust systems will be developed for (magnetic and inertial) fusion power plants. Table 1 lists accomplishments during the past 20 years in the pellet fueling area and requirements for a demonstration D-T device about 20 years in the future.

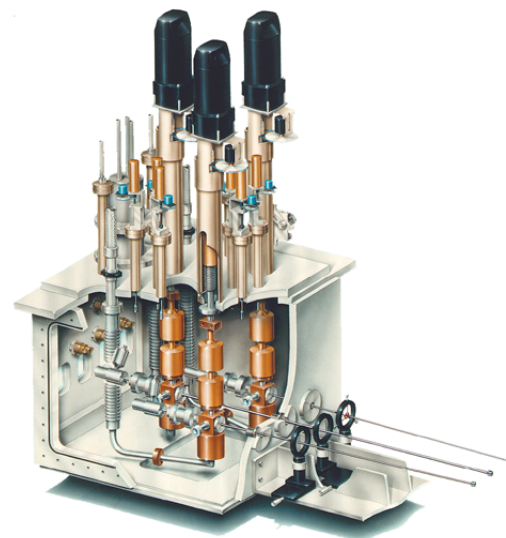

A three-barrel repeating pneumatic injector (RPI) (presently installed on DIII-D).

Table 1. Accomplishments in pellet fueling

Parameter	1978 Status	1998 Status	2018 Goal
Pellet isotope	Hydrogen (H)	H/D/T	H/D/T
Pellet size	One to few millimeters	0.5–10	0.5–12 mm
Pellet inventory	One to few millimeters	1–1200	~50 g
Pellet feed rate	N/A	0.26 g/s	0.1 to ~0.5 g/s
Pellet speed	Hundreds of meters per second	Thousands of meters per second	Up to 5 km/s
Reliability	Unknown	Sufficient for short pulse	~99% for steady state

Proponents and Critics Claims

Proponents claim that plasma fueling using a combination of gas puffing and pellets can meet the requirements of present large plasma devices and future fusion reactors. High-field-side pellet launch at modest speeds can deliver the required hydrogenic mass to the burning plasma region. CT fueling shows enough promise to be applied to larger plasma experiments, such as the planned system on LHD.

Critics claim that gas puffing has too low a fueling efficiency for core fueling of large D-T plasma devices because of the dense, thick scrape-off region. Pellets launched at realistic speeds from the low-field side can provide core fueling, but only a small fraction of the pellet mass actually reaches the central hot, burning, plasma region. CT fueling may access the plasma center, but there is no evidence of efficient, localized fueling; and repetitive D-T systems appear complicated and unreliable.

T-5. DIVERTOR

Description

The power flowing out of the core of a fusion reactor is in the gigawatt range. Cost considerations lead to minimization of the volume of such a reactor which results in a concentration of the power efflux that must be safely dissipated onto the surrounding first wall. Safely, in this sense, means that the actual heat load on the wall must not result in rapid wall erosion and/or high core impurity concentrations. Although the majority of the power flow out of the core is in neutrons and radiation, the remaining several 100 MW is carried by charged particles and hence flows along the magnetic field. Tokamaks have developed a magnetic topology such that the magnetic flux tubes at the edge of the hot core plasma are “diverted” away from the hot core to first-wall surfaces that are as far removed from the core as possible. This has the advantage that (1) the magnetic flux tubes can be manipulated to spread the power efflux over large areas, thus reducing the heat loads, wall damage, and erosion; (2) impurities generated by interaction of the plasma efflux with the first wall will be ionized in the divertor plasma rather than the hot core, thus minimizing radiation cooling and impurity fuel dilution in the core; (3) large gradients can be developed along these flux tubes (open field lines) bringing the plasma temperature down to low values (as low as 1–2 eV) that further insulates the hot core from the cold surrounding walls; and (4) helium, is concentrated in the divertor, thereby providing pressures that ensure that it can be pumped away and thus not build up in the core plasma.

Status

Divertors have not only provided better power removal characteristics than alternative power-handling scenarios, but they have also led to enhancements in the core energy confinement by factors of ~2 and have consequently become the dominant tokamak configuration. Three modes of divertor operation are recognized: (1) “sheath-limited,” featuring constant temperature along field lines; (2) “high-recycling,” where temperature gradients form along field lines keeping plasma pressure constant; and (3) “detached.” Detachment is characterized by a nearly complete quenching of the plasma in the divertor through atomic processes, significantly reducing particle and heat flow to the divertor surfaces (and the resultant erosion and impurity generation). This effectively insulates the divertor surfaces from the core. Because of these advantages, most current tokamaks utilize and study detached divertor operation.

An understanding of the relationship between atomic/molecular physics and basic plasma transport of energy and momentum on open field lines has been developed. As a result, the capability for numerical simulation of the divertor plasma (fuel and impurity species) has improved dramatically. Codes can now accurately reproduce most of the key characteristics of these plasmas. The anomalous transport coefficients needed in these simulations are not well understood, thus limiting their predictive capability.

Other magnetic confinement concepts, such as stellarators and reversed-field-pinches (RFPs), are beginning to pursue this same concept for the attractive reasons discussed above. The physics of open field line transport, the interaction of atomic physics with transport, and the dissipation of large power flows are fundamental to all magnetic fusion concepts, as well as all such high power density devices such as inertial fusion and plasma processing of waste.

Current Research & Development (R&D)

R&D Goals and Challenges

- Characterize and understand the physics processes that determine perpendicular transport.
- Current models make predictions of the importance of different atomic and transport processes in the determination of conditions in the divertor. More detailed experimental measurements are required to verify the code assumptions.
- Extend divertor operating regimes to lower density and current drive. We need to develop a better understanding of impurity transport to maximize impurities in the divertor (for power dissipation through line radiation) while minimizing impurity levels in the core (minimizing core radiation power losses).
- Extend the use of divertor topology to other magnetic confinement devices. Designs have been made to exploit the natural diversion of flux surfaces in stellarator devices to achieve the same impurity control seen in tokamaks. RFPs and spherical torus are also exploring the use of this topology.
- There is much in common between open field line transport and other areas of physics, particularly solar plasmas. In some case divertor plasmas can become nonideal, leading to a commonality of physics with inertial confinement fusion (ICF) plasmas. Cross-fertilization between these areas should be pursued.

Related R&D Activities

Strong collaborative tokamak programs with Japan, the Russian Federation, and Europe. Beginnings of application of divertor to stellarators and RFPs and plasma processing. Exploration of solar prominences.

Recent Successes

Identified a number of basic atomic physics processes important to divertor plasmas—ion-neutral collisions, three-body recombination, impurity line radiation. Studies indicate that detachment is due to a synergy between atomic physics and transport whereby line radiation removes power, ion-neutral collisions remove momentum, and recombination removes particles. The experimental characterization and models of the divertor plasma have also been greatly advanced.

Anticipated Contributions Relative to Metrics

Metrics

The magnitude of parallel heat flow to the divertor region is $\sim 0.5 \text{ GW/m}^2$. Other magnetic confinement devices could have higher levels. Engineering safety standards for use of water cooling mandate that the perpendicular component of this flow to the divertor surfaces must be kept below $5\text{--}10 \text{ MW/m}^2$ in steady state. The plasma particle and heat flux must be kept low, minimizing the erosion rate of the divertor surface due to evaporation and physical sputtering, such that the surface only need be replaced every 3–5 years. The divertor helium density must be kept high ($0.1\text{--}1 \text{ mTorr}$) to allow proper disposal of fusion waste and restricting levels in the core plasma. The level of medium-Z impurities ($Z = 4\text{--}20$) in the core plasma must be kept low ($Z_{\text{eff}} \leq 1.6$) to minimize radiation cooling of the core and plasma dilution.

Near Term ≤ 10 years—Develop knowledge base and address feasibility issues

- The reversed-shear, enhanced confinement approach to tokamak fusion requires lower plasma density. This reduces the effectiveness of the divertor plasma in dissipating the power flows entering the divertor. A concentrated effort is needed, both experimentally and theoretically, to extend the advantages of the detached divertor and impurity trapping to lower densities.
- Extend the high-density divertor operation to even higher powers. This will address the needs of the compact, high-field tokamak and spherical tori approach to fusion.
- Improve the understanding and effectiveness of the divertor retention and trapping of impurities using externally enhanced divertor ion flows.
- The vertical plate divertor is a very effective version of the various divertor geometries. Given the new modeling capabilities and device constraints, efforts must be made to continue to enhance the divertor effectiveness.
- Use experiments and theory to better understand the coupling between the divertor region and the edge/pedestal region of the core plasma. Understanding of this coupling may aid control of the pedestal region so important for core confinement and may permit control of ELMs, which pose a problem for divertor design.
- As other types of devices start using divertors, it will become important to increase the knowledge flow between laboratories. This will allow cross-fertilization of ideas.

Science

- Improve turbulence measurements and modeling such that a physics-based model of perpendicular transport can be derived. Testing of such a model over a wide range of divertor plasma edge conditions will lead to increased confidence in the predictions of two-dimensional (2-D) modeling codes. Interpretational analysis of edge conditions should be continued to enable empirically based scalings for edge transport. This can be used to check the physics-based models and/or serve as a substitute input to divertor modeling codes.
- Develop diagnostics capable of measuring the divertor quantities that determine detachment. These include ion and neutral flow velocities, ionization rate, recombination rate, and ion temperatures. These must be measured in sufficient detail to permit careful evaluation of computer divertor physics models. Use the models more to guide potential improvements in divertor operation.

Midterm 10–20 years—Extend the divertor operating boundaries

- Extend useful divertor operation. Low-density operation leads to challenges in obtaining the gradients along open field lines that are advantageous.
- Very long-pulse operation will allow the study of wall-equilibration effects where wall diffusion of neutrals can occur over very long periods (minutes and hours).
- Wall conditions (e.g., cleanliness, D_2 loading) appear to have an important influence on core confinement. Programs are needed to interpret and control this effect.
- Increase experimental power flows to reactorlike levels and optimize the divertor operation accordingly.
- Develop more comprehensive modeling tools that take into account both the core plasma and the wall effects.

Long Term > 20 years—Optimize a specific confinement device

Synthesize the knowledge obtained in multiple types of devices to optimize performance in a fusion device that is selected after proof-of-principle.

Proponents' and Critics' Claims

Proponents think that the clear capabilities of the divertor topology hold promise for the tokamak as well as other magnetic fusion devices. Important advances have been made over the last 5 years; given the proper funding, more improvements in divertor performance will be made. This will have application to a number of potential fusion devices as well as other physics areas.

Critics note that advances are being made, but the demands of the variety of fusion applications will outstrip the capability of the divertor to handle them all. Effective divertor operation may conflict with core plasma requirements (e.g., impurity levels and operating density).

T-6. HIGH HEAT FLUX COMPONENTS AND PLASMA MATERIALS INTERACTIONS

Description

The successful development of high-performance plasma-facing components (PFCs) is central to the overall development of fusion energy and has posed progressively more difficult challenges as the power of fusion devices has increased. We must have robust PFCs in long-pulse and steady-state deuterium-tritium (D-T) devices. Helium ash removal requires particle flow to the first wall divertor regions, and with the particles comes intense local heating. PFCs are bombarded by energetic neutrals, ions, electrons, and photons, and must survive intense plasma-materials interactions (PMIs). In D-T devices, remotely maintained PFCs must survive neutron radiation and cyclic thermal heat loads while avoiding unacceptable tritium inventory. PFC research includes plasma science, surface science, PMIs, technology development, and advances in engineering. There must also be strong direct links with the Plasma Science Program.

Status

The PFC element has determined the basic materials processes and mechanisms responsible for carbon/tritium redeposition. The PFC element has reached two important milestones linking basic plasma science and technology: (1) benchmarking of theoretical codes such as REDEP with tokamak data and (2) characterization of mixed wall materials and their effects on the plasma. The program has achieved long-term reliability of beryllium and tungsten joints to copper for high surface heat fluxes. Investigation of low activation materials and liquid surfaces is starting. Two International Thermonuclear Experimental Reactor (ITER) milestones will be completed in FY 1999: (1) the ITER divertor cassette prototype fabrication and its verification testing (with industry) and (2) optimization of joining technology for PFCs with demonstration of component reliability. We have demonstrated the viability of in-situ plasma spray repair of beryllium. The effects of lithium wall conditioning on first wall materials are being studied extensively in tokamaks and off-line simulators. Two joint basic science working group activities with the plasma science community have started: investigation of the PMI needs of candidate alternate concepts and investigation of the basic science behind the processes responsible for thermal and plasma wall conditioning.

Current Research and Development (R&D)

R&D Goals and Challenges

- Provide the plasma science and materials expertise necessary to understand, ameliorate, and exploit the interactions between the fusion plasma and the wall and components that surround it.
- Qualify the plasma-facing materials, technology, and components necessary to continue progress in the tokamak.
- Develop the PFC technology essential to support the maturation of early-concept alternate magnetic fusion confinement and inertial fusion energy reactor concepts for long-pulse and steady-state devices.
- Solve the competing requirements associated with minimizing contamination to the plasma through (1) selecting armor, (2) maximizing the heat removal, (3) cleverly engineering heat sinks, and (4) joining these features (our greatest challenge).

Related R&D Activities

In the Joint European Torus (JET), the United States is helping to characterize and model the complex phenomena associated with erosion/redeposition of their carbon divertor. Plasma edge diagnostic measurements are also proposed for ASDEX-U. Wall conditioning studies are under way in the Tokamak Experiment for Technology Oriented Research (TEXTOR) and the Large Helical Device (LHD). The DiMES facility and U.S. plasma test facilities are being used to study the fundamental science of erosion/redeposition and tritium retention/removal with our Japanese and European colleagues. The United States is testing actively cooled divertor concepts from Russia, Japan, and the European Union.

Recent Successes

- Understanding of the physics of carbon-tritium codeposition in divertors has been demonstrated in the Doublet III-D (DIII-D) divertor.
- Significant progress has been made on understanding the physics of materials response during off-normal heating using the HEIGHTS computer model package.
- Substantial progress has been made on cooling technology. We have achieved >3000 cycles at 10 MW/m² with Be/Cu and over 20 MW/m² with W/Cu (water cooling). Heat removal of over 35 MW/m² has been achieved with helium cooling.
- Plasma spray repair of eroded beryllium has been demonstrated in the laboratory using beryllium tiles originally eroded in ISX-B operation. The repaired surfaces were shown to adhere well during subsequent high heat flux testing.
- The formation of mixed material and in-vessel tritium removal techniques for codeposited carbon-tritium films has been studied in laboratory simulation experiments.

Budget

The FY 1999 budget for PFC technology is approximately \$6.5M.

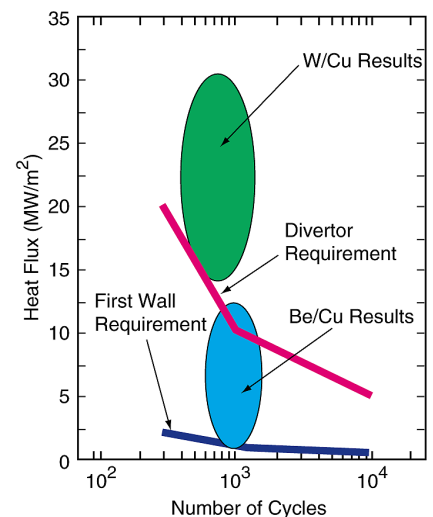

Anticipated Contributions Relative to Metrics

Metrics

PFCs must be able to survive PMIs such as sputtering without plasma contamination. The allowed plasma contamination for impurities depends strongly on the atomic number of the material. Either eroding materials that have a low atomic number or a high atomic number or refractory materials with low erosion are favored. Since erosion of carbon-based materials leads to tritiated codeposited films, alternatives to graphite must be developed. PFCs must remove steady-state surface heat flux up to 50 MW/m² and withstand off-normal heating. Finally, PFCs must be able to survive neutron irradiation simultaneously with cyclic heating under high stress with adequate lifetime and be compatible with remote handling and maintenance.

Near Term <5 to 10 years

The test of the first theoretical code, which couples a core plasma to the first wall while integrating all of the known major plasma/first wall interactions, will be completed. This will allow for significant improvements in the design of more accurate alternate-concept proofs-of-principle and new machines. By 2005, the program will provide the next generation of reliable solid-state sensors (“smart tiles”) required for the understanding of PMIs in tokamak and alternate-concept plasmas. A demonstration of new conditioning techniques compatible with high magnetic fields will also be performed. We will complete the fabrication, demonstration, and deployment of an innovative PFC that will have both a 50% increase in critical heat flux (CHF) as well as a 50% increase in erosion lifetime. Innovative wall conditioning techniques such as electron cyclotron discharge cleaning that can be used in steady-state devices will be developed.

We will continue to work with JET, LHD, W7-X, and KSTAR to develop innovative manufacturing techniques such as plasma spray technology, advanced joining techniques, and new plasma-facing materials. Collaborative power deposition measurements and modeling for the Tore Supra CIEL components are under discussion. A free surface liquid divertor project (ALPS) has been initiated to study the potential of liquid surfaces for active heat removal without concern for PFC lifetime limits. This program will determine the scientific limits for heat removal, plasma contamination control, particle pumping, and magnetohydrodynamic effects for liquid surfaces exposed to fusion plasmas.

Midterm ~20 years

In 20 years we will reach our goal of PFCs that are plasma compatible and can remove a steady-state surface heat flux of 50 MW/m² without the need of periodic maintenance to renew the plasma-facing material. This goal may be accomplished through the deployment of PFCs with free surface liquids or with nonsputtering, helium-cooled refractory components protected from off-normal heat loads by transpiration cooling. High-temperature coolant operation will allow the PFC heat to be removed as useful heat for power production.

Long Term >20 years

Robust plasma-facing wall technology (e.g., free surface liquids) will be applied to both magnetic and inertial fusion energy reactors.

Proponents' and Critics' Claims

Proponents argue that tremendous progress has been made in the last decade in the area of heat removal engineering and control of PMIs. The goals required for fusion energy reactors are attainable within the next 20 years. Critics would counter that the successful development of PFC materials and the remote maintenance of PFCs in the harsh radioactive environment of a D-T reactor is impossible.

Other Potential Applications

The science and technology developed for fusion high heat flux components coupled with the science of PMIs have the potential to contribute to several other areas.

- The high heat flux components can be applied to the leading edges of hypersonic aircraft and rocket nozzles.
 - The heat removal advances have been used to improve the performance of radio frequency tubes (e.g., klystrons) and high-energy beam targets.
 - Innovative gas, liquid-metal, and water-cooling methods may have applications in computers, power generation, and solar power.
 - Plasma coatings are already an important industrial product. Improved PMI science will lead to new applications and improved products.
 - Low-temperature joining of copper alloys preserves their strength, allowing copper to be used in a wider array of applications.
 - The grain boundary strengthening of refractory alloys has many possible applications in aerospace and nuclear industries.
-

T-7. MFE LIQUID WALLS

Description

The free-surface liquid wall/liquid blanket concept is an innovative approach that involves flowing liquids around the plasma to serve the functions of first wall/blanket/divertor (heat and particle extraction, tritium breeding). Ideally, only liquids (with no or little structural materials) are contained inside the vacuum vessel. The liquid wall/liquid blanket concepts are being investigated in the Advanced Power Extraction (APEX) study, which is aimed at exploring innovative concepts for fusion power technology that can tremendously enhance the potential of fusion as an attractive and competitive energy source. Specifically, APEX is exploring new and “revolutionary” concepts that can provide the capability to efficiently extract heat from systems with high neutron and surface heat loads while satisfying all the functional requirements and maximizing conversion efficiency, reliability, and maintainability as well as safety and environmental advantages. Compared to traditional solid first wall/shield blanket concepts, the liquid wall/liquid blankets offer the following major advantages:

- Fast-flowing liquid in the first wall allowing for (1) a very high power density capability and (2) a renewable first wall surface.
- Thick-flowing liquid blankets dramatically reducing (1) radiation damage and (2) activation in structural materials.
- Lower unit failure rates, particularly because of elimination of welds in high radiation field regions.
- Easier maintainability of in-vessel components.
- Much higher coolant temperature and conversion efficiency.
- Improved tritium breeding potential.
- Concept applicable to a wide range of confinement schemes.
- Simpler technological and material constraints.
- Reduced research and development (R&D) requirements concerning cost and time scale.

Required facilities are simpler and cheaper because they reduce the need for testing in the nuclear environment. The working liquid must be a lithium-containing medium to provide adequate breeding. Practical liquids are lithium, tin-lithium, and fluorine-lithium-beryllium (Flibe). Lithium and tin-lithium flows have strong magnetohydrodynamic (MHD) effects. Flibe does not experience significant MHD forces.

Status

- Although liquid walls/liquid blankets were proposed for magnetic fusion energy (MFE) in the 1970s [and for inertial fusion energy (IFE) in the 1980s], serious evaluation, analysis, and R&D has started only recently in the framework of the APEX study.
- Several promising schemes have been developed to ensure compatibility of free-surface liquids with plasma operation: (1) fast-flowing liquid jet, separate from slow-moving liquid blanket, to keep surface temperature of lithium (and hence evaporation rate) low; (2) discovery of a new lithium-containing material (SnLi) that has low vapor pressure at elevated temperatures; and (3) development of new schemes for enhancing turbulence (and hence heat transfer) at the liquid surface.
- Analytical and computational analysis shows the scientific feasibility of a flowing film, on concave surfaces, in equilibrium under the acting forces with attractive performance parameters.
- Three-dimensional (3-D) hydrodynamic computations and thermophysics calculations show the feasibility of an all-liquid wall/liquid blanket without the use of structural materials in a field reversed configuration (FRC).
- Several promising schemes for utilizing liquid walls/liquid blankets in spherical torus (ST) and advanced tokamak configurations have been proposed and are being investigated in APEX.

Current Research and Development

R&D Goals and Challenges

Among the challenges of liquid walls being addressed in APEX are (1) determining limits on the amount of material allowed to evaporate or sputter from liquid surfaces based on sophisticated plasma edge modeling, (2) evaluating temperature profiles on fast-flowing free-surface jets in the fusion environment, (3) establishing hydrodynamic models and exploring various thick-liquid formation schemes in different MFE confinement configurations, (4) developing a 3-D free surface hydrodynamic and heat transfer simulation code that incorporates MHD effects, (5) assessing multidimensional effects (e.g., penetrations) and the impact of time-varying magnetic fields on the flow characteristics, and (6) identifying high-temperature structural materials that are compatible with Flibe and SnLi for use in nozzles, vacuum vessel, and other regions behind the liquids.

Related R&D Activities

- Free-surface liquids flowing on divertor plates are being evaluated in the ALPS study.
- Liquid walls are also being investigated under IFE Chamber Technology R&D.

Recent Success

- Multidimensional fluid mechanics and heat transfer calculations with Flibe show excellent promise. The flow characteristics and performance parameters show that attractive liquid wall configurations can be formed in FRC, ST, and advanced tokamaks.
- A new liquid (SnLi) with breeding capability and low vapor pressure at elevated temperature was discovered.
- Recent results from small-scale liquid jet experiments conducted at University of California—Los Angeles (UCLA) and UC Berkeley are promising.

Budget

Liquid walls represent a dominant part of APEX. Funding for FY 1999 = \$2.3M for the national team working on APEX.

Anticipated Contributions Relative to Metrics

Metrics

The metrics for a liquid wall concept include (1) high power density capability—neutron wall load $>10 \text{ MW/m}^2$ and surface heat flux $>2 \text{ MW/m}^2$; (2) high power conversion efficiency ($>40\%$ net); (3) low failure rates; (4) faster maintenance (MTBF > 44 MTTR, where MTBF is mean time between failures and MTTR is mean time to repair); and (5) simpler technological and material constraints. (The ability to achieve a high repetition rate of $>5 \text{ Hz}$ is another key requirement for IFE chamber designs using liquid wall protections.)

Near Term ~5 years

- Identification of the most promising hydrodynamics configurations with respect to different MFE confinement schemes.
- Experimental data on the achievable minimum liquid surface temperatures without MHD effects for turbulent Flibe and MHD laminar lithium/tin–lithium flow under high power density conditions.
- Identification of practical heat transfer enhancement schemes necessary for minimizing liquid surface temperatures.
- Experimental characteristics of small-scale hydrodynamics configurations applicable to MFE confinement schemes without MHD effects.
- Computer simulation results of MFE relevant, 3-D, free-surface liquid wall thermal and hydrodynamics performance with MHD effects. In particular, hydrodynamics characteristics near the penetrations supply and return lines.
- Modeling and test results of the maximum allowable evaporation rate from the liquid surface with respect to different MFE confinement schemes.
- Experimental results of vapor condensation rate applicable to cavity-clearing performance of IFE liquid wall protected chambers.

Midterm ~20 years

- Experimental characteristics of MFE relevant large-scale (e.g., half-scale) hydrodynamics configurations under high-power surface heating loads and magnetic fields.
- Modeling and test results of the plasma-liquid wall interactions.
- Full-scale tests in available deuterium-tritium (D-T) burning fusion facilities (e.g., Volumetric Neutron Source).

Long Term >20 years

- Liquid walls/liquid blankets are used as the in-vessel components of an engineering test reactor and demonstration reactor.

Convective Liquid Layer Design

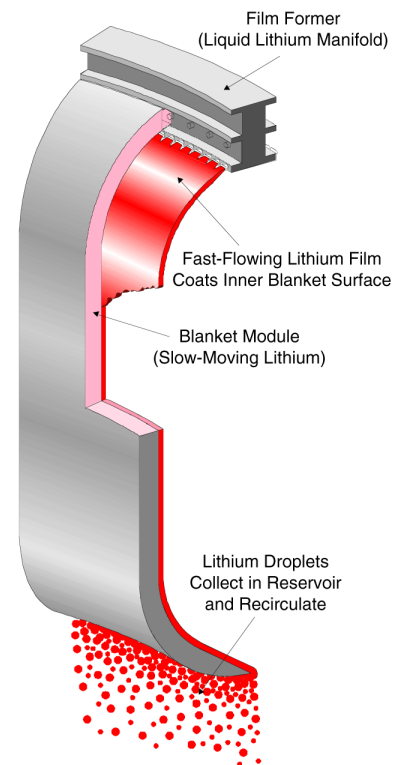

Conceptual drawing of a liquid wall/liquid blanket/liquid divertor

Proponents' and Critics' Claims

Proponents claim that liquid walls/liquid blankets can (1) tremendously enhance the potential of fusion as an attractive and competitive energy source and (2) substantially reduce the time and cost of fusion R&D. The attractive potential relative to other concepts (solid first wall/shield blanket) include a higher power density capability, higher efficiency, higher plant availability (longer MTBF and shorter MTTR), and elimination or reduction of structural materials' activation and radiation damage. The reduction in time and cost from R&D results from elimination of the need for separate neutron-producing facilities for testing.

Critics are concerned with increased plasma impurities arising from vaporization from liquid surfaces. They are also concerned that not much serious evaluation has been made of liquid wall designs (until recently).

T-8. SHIELD/BLANKET

Description

The overall attractiveness of fusion for energy production depends directly on the shield/blanket (S/B) to provide efficient power conversion, adequate fuel to replace the tritium used in the plasma, shielding protection for other components, and a sufficiently long lifetime for high availability. The safety advantages of fusion depend on the materials and operational choices for the S/B. The S/B consists of a structural first wall; a breeding zone (containing a lithium-bearing material, a coolant, and a small percentage of structure); and a shielding zone (containing special shielding materials, coolant, and a small percentage of structure). Breeding blanket concepts include a lithium-bearing liquid that can serve as both the breeding material and coolant or using solid lithium ceramics for tritium breeding with a separate coolant such as water or helium. Beryllium is sometimes used as a neutron multiplier to enhance the tritium breeding.

Status

Previous S/B work focused on a reduced number of concepts. The two lead concepts were the separately cooled solid breeder blanket and the self-cooled liquid lithium blanket. The concepts emphasized the use of reduced activation materials such as vanadium alloys, ferritic alloys, and SiC. Much of the recent U.S. effort in this area has been devoted to the International Thermonuclear Experimental Reactor (ITER) shield development. The major conclusion of this work is that it is possible to design and construct a shield that satisfies the needs of ITER using existing materials and fabrication techniques. With the restructuring of the U.S. Fusion Program, the level of effort devoted to the S/B has been greatly reduced. There are emerging opportunities for the future, however, with the evaluation of advanced, high power density systems. These systems make use of expanded materials choices including high-temperature refractory alloys and new breeding materials such as liquid SnLi alloys.

Current Research and Development (R&D)

R&D Goals and Challenges

The R&D goals of the S/B follow:

- Resolve key feasibility issues for specific concepts. Examples include insulator coatings to reduce the magnetohydrodynamic (MHD) pressure drop for liquid metal systems, tritium self-sufficiency, compatibility/tritium containment for fluorine-lithium-beryllium molten salts (Flibe), and thermomechanics and interface heat transfer for solid breeder systems.
- Develop a basic understanding of fundamental effects in candidate systems. Examples include MHD effects on fluid flow, chemical behavior at interfaces between solids and coolants, and irradiation effects on the behavior of S/B materials.
- Develop one or more attractive S/B options using integrated tests that meet the breeding, power density, lifetime, and power conversion metrics for the system (see below).

The S/B has many competing requirements that tend to reduce the operating margin of the system, and meeting all operating requirements simultaneously is the major challenge. In addition, no existing facilities provide the complete fusion environment. The IFMIF facility planned for 14-MeV neutron irradiation of materials has a very limited working volume that precludes large-size S/B testing. The construction of an ITER-like device or a volumetric neutron source would, however, provide both the proper environment and volume needed to fully test the performance of candidate S/B concepts.

Related R&D Activities

The United States has worked for many years with other countries in the development of the S/B. The EU has a large program devoted to the development of two S/B concepts—a water-cooled system with PbLi as the breeder and a helium-cooled system with a solid breeder and a beryllium multiplier in pebble form. Both concepts use ferritic alloys as the structure. In Japan, the main effort has been in the development of solid breeder concepts, but there are also programs investigating liquid metals and Flibe. In Russia, both liquid metal and solid breeder systems are being studied. An existing International Energy Agency (IEA) agreement in fusion technology provides a mechanism for formalizing collaboration in this area. In the United States, the Advanced Power Extraction (APEX) program is providing a means for investigating key issues for the S/B.

Recent Successes

- Development of copper/stainless steel joining techniques for the ITER first wall and shield.
- Improved understanding of interface heat transfer for solid breeder systems.
- Improvements in beryllium fabrication technology for use as a neutron multiplier.
- Development on a small scale of calcium oxide as an insulator coating.
- Development of MHD models and codes for predicting flow behavior and heat transfer in liquid-metal-cooled systems.
- Decay heat data verification through integral experiments using 14-MeV neutron sources.
- Experimental simulation of shielding performance and characteristics of a superconducting magnet using a 14-MeV neutron source.

Budget

FY 1999 = <\$1M.

Anticipated Contributions Relative to Metrics

Metrics

- Tritium breeding ratio $>1+$ where the amount over 1 depends on the plasma burnup fraction and inventory in components and the tritium processing system.
- Power density of 5- to 10-MW/m² neutron wall loading with a first-wall surface heat load of 1 to 2 MW/m².
- Component lifetime—15 to 20 MW-year/m².
- Power conversion efficiency $>40\%$.

Near Term <5 to 10 years

Key feasibility issues would be addressed primarily through modest cost, laboratory-scale experiments, and dedicated integral experiments using existing 14-MeV point source facilities. Specific tests to obtain information needed to assist the evaluation of various concepts in APEX would also be performed. Issues to be addressed include the development of insulator coatings, heat transfer capability in candidate systems at high power density, and tritium self-sufficiency. Proof-of-principle tests would be performed in collaboration with EU, Japan, and the Russian Federation to establish the technological limits of worldwide evolutionary concepts (solid breeder, liquid metals).

Midterm ~20 years

Attractive S/B systems, identified during near term tests, would be tested at midscale to large-scale in nonfusion environments. Both single- and multiple-effects tests would be performed. Tests include combining MHD fluid flow with surface heating, in-reactor tritium breeding and recovery tests, and scale-up of fabrication methods for S/B materials and assembly. Phenomenological models would be developed that could be used for developing full-size modules for fusion testing. The primary objectives are to achieve the all S/B metrics individually.

Long Term >20 years

The leading S/B systems would be tested in a fusion environment (e.g., volumetric neutron source). The systems to be tested would be modules with a first-wall area of 1 to 4 m² and a thickness of ~0.5 m that would be fully prototypical of advanced power devices. Each module would have its own heat exchange, tritium recovery, and diagnostic systems. The primary objective is to achieve the all-S/B metrics simultaneously in fully integrated tests.

Proponents' and Critics' Claims

Proponents claim that satisfactory systems can be developed, but it may be necessary to go beyond the established concepts. Critics contend that there are too many requirements, and they cannot all be satisfied simultaneously. The complex geometry of toroidal systems makes the design and maintenance of S/B systems very difficult.

T-9. RADIATION-RESISTANT MATERIALS DEVELOPMENT

Description

- The in-vessel components of conceptual fusion power systems fueled with deuterium-tritium (D-T) will be subjected to intense fluxes of 14-MeV neutrons. Advanced design studies have shown that the conditions in which structural materials in the first wall and blanket system will have to perform (see metrics) are severe, well beyond those of any other energy system. It has been established that conventional materials, even those developed for fast breeder fission reactors, will not have sufficient performance capability for fusion. Development of materials to function in this environment is a basic feasibility issue for fusion as an energy system.
- Energetic neutrons interact with the structure: (1) high energy recoil-atoms produce clusters of defects within the host lattice (displacement damage), (2) nuclear reactions produce activated species, and (3) nuclear transmutations produce changes in composition and generate hydrogen and helium. The combination of displacement damage and transmutant gases produce major changes in physical properties (dimensional stability and conductivity) and mechanical behavior (strength, ductility, and fracture toughness). The magnitudes of these property changes are dependent on material parameters (composition and microstructure) and on environmental parameters (neutron fluence, flux, spectrum, temperature, cyclic loading, and coolant chemistry).
- Radiation-induced radioactivity of the structural materials impacts both safety (decay heat and isotope inventory) and waste disposal (decay characteristics and specific activity) attributes of fusion power.
- The goal of the Advanced Materials Program is to provide the materials science base for the development of the materials necessary for the use of fusion energy.

Status

- Based on an analysis of safety, radioactive waste disposal, and possible materials recycle, three low-activation materials systems have been identified with the potential to meet the performance needs for a range of conceptual blanket systems. These systems are (1) Fe-Cr-WV ferritic steels, (2) V-Cr-Ti alloys, and (3) SiC/SiC composites. Copper-based alloy systems for heat sink applications have also been identified. A significant database for each class of materials has been generated, along with material processing, fabrication, joining, physical and mechanical properties, chemical compatibility, and radiation effects.

Current Research and Development (R&D)

R&D Goals and Challenges

Based on the earlier work, a roadmap has been developed that identifies the technological challenges that must be met to establish the feasibility of each class of materials. The key cross-cutting phenomena that determine materials performance have been defined, and a fully integrated theory-modeling-experimental program is being formulated to provide the fundamental information needed to expand the performance capabilities of current materials. An intense 14-MeV neutron source will be needed to qualify materials (see IFMIF).

Related R&D Activities

Strong collaborative materials R&D programs exist between U.S. Department of Energy (DOE) and programs in Japan conducted by Japan Atomic Energy Research Institute (JAERI) and by Monbusho. Arrangements are in place for irradiation experiments in the Russian Federation. The DOE–Office of Basic Energy Sciences (BES) and the Department of Defense (DOD) have programs on basic radiation effects in materials, advanced microstructural analysis, multiscale modeling, and fundamental relationships between structure and properties. Materials R&D in the United States, Japan, EU, Russian Federation, and China is coordinated and communicated through the International Energy Agency (IEA) Implementing Agreement on a Program of Research and Development on Fusion Materials.

Recent Successes

A new set of ferritic steel compositions containing 7–9% Cr were identified; these have been adopted as the basis for the IEA development program for low-activation steels. Radiation-induced amorphization studies of SiC have yielded fundamental information in point defect mobilities of significant value to the electronics industry. The first SiC composites tailored for service in an irradiation environment have been synthesized.

Budget

The FY 1998 budget for advanced materials was \$5.9M. Based upon FESAC recommendations, the annual budget needs to increase to \$8–9M for FY 1999–2001. Larger budgets will be needed later to meet goals. A multinational project in the range of \$0.81–1.2B will be needed in out-years to construct a 14-MeV neutron source.

Anticipated Contributions Relative to Metrics

Metrics

The first wall and blanket should be able to handle neutron fluxes $\geq 3 \text{ MW/m}^2$, together with heat loads of $\sim 20\%$ of the neutron flux; and withstand primary and cyclic secondary loadings, maintain chemical compatibility with the coolant, and be able to accommodate high loading rates during plasma disruption. The lifetime neutron fluence goal is around 15 MW/m^2 .

Near Term <5 to 10 years

• Develop Knowledge Base and Address Feasibility Issues

- Vanadium alloys
 - Develop a self-healing magnetohydrodynamic (MHD) insulator coating for lithium-cooled systems.
 - Develop welding methods applicable for construction of large systems.
 - Develop metallurgical approaches to expand the current operating design window.
- Ferritic steels
 - Establish acceptability of ferromagnetic materials in magnetic fusion energy (MFE) concepts.
 - Establish the magnitude of combined effects of radiation hardening and helium generation on fracture behavior.
 - Explore oxide dispersion strengthening as a means of improving high-temperature strength and expanding upper operating temperature limits.
- Silicon carbide composites
 - Develop composites with advanced fibers and interphase structures with improved radiation damage resistance.
 - Establish the effects of radiation on the thermal conductivity and establish the level of allowable heat fluxes.
 - Develop joining and sealing technologies.

• Science

Establish a knowledge base and a fundamental understanding of key phenomena that control materials performance in the fusion environment based on the development of multiscale, physically based models coupled with an experimental program that targets specific mechanisms. Address feasibility issues defined in the program roadmap for each class of materials.

• Applications

Bainitic steels have superior strength, toughness, and weld properties relative to steels currently used for elevated-temperature applications in the power generation, chemical, and petroleum industries. Studies of radiation-induced, nonequilibrium segregation and precipitation phenomena provide the understanding necessary to develop improved creep-resistant steels for improved performance in advance fossil power facilities. New composite materials incorporating stoichiometric SiC fibers offer improved thermal stability and oxidation resistance for fossil power applications.

Midterm ~10–20 years

• Materials Development

- Focus on materials with established feasibility and develop improved properties to expand performance windows, coupled with close interaction with advanced design studies.
- Establish primary production, fabrication, welding, joining, chemical compatibility, and a full range of mechanical performance.
- Establish the satisfactory radiation performance of advanced materials subjected to a 14-MeV neutron environment.

Long Term >20 years

• Materials Engineering

- Provide the materials property database for design, licensing, construction, and operation of a fusion power system.
- Demonstrate full-scale production and fabrication of materials and determine properties of materials following thermal-mechanical cycles involved in full-scale component production.
- Define all aspects of materials performance in response to complexities of the operating environment, including varying temperature and stress cycles and off-normal and accident conditions.

Proponents' and Critics' Claims

Proponents consider that advances are being made and will continue to allow materials to be tailored for specific purposes. Irradiation resistance is hard to achieve, but through experiment, theory, and modeling, structural materials will be developed to meet fusion energy needs.

Critics contend that advances are being made, but the demands of fusion are too severe to allow materials of reasonable cost to be developed.

T-10. INTERNATIONAL FUSION MATERIALS IRRADIATION FACILITY

Description

One of the major materials issues to be faced in developing attractive fusion power is the effect of the intense neutron fluxes associated with deuterium-tritium (D-T) fusion concepts. The first-wall neutron spectrum that contains a large 14-MeV component not only results in very high displacement rates (~ 20 dpa/year at 2 MW/m^2) but also causes much higher transmutation rates than are experienced in fission reactors. The elements helium and hydrogen are of particular concern, but other impurities can also be important. The influence of these transmutation products on property changes has been very well established; the obvious example is the role of helium in swelling behavior.

While fission reactors are likely to provide the bulk of irradiation facilities for the foreseeable future, accelerator-based neutron sources have been proposed to provide the spectral response, high fluxes, and high fluences needed for the investigation of fusion materials. Such a source would be needed to validate and extrapolate the results from fission irradiations to fusion conditions, to develop materials, and to provide design data for future high-fluence fusion devices [e.g., demonstration reactor (DEMO)]. Until suitable materials are developed in this way, the technology to design and build fusion-based facilities will not exist.

Status

A D-lithium (Li) based source [Fusion Material Irradiation Test (FMIT)] project was begun in the early 1980s but was cancelled before completion. R&D for that project demonstrated continuous wave (CW) operation of the low-energy portion of the accelerator, and a prototype of the liquid lithium target ran for many thousands of hours.

More recently the international community has proposed the International Fusion Materials Irradiation Facility (IFMIF), a concept similar to the FMIT project but incorporating a number of advances in accelerator technology that have been made since that time. The final report of the conceptual design activity has been completed¹ and a number of R&D issues addressed during the conceptual design evaluation phase. The estimated construction cost of the facility is ~ 0.8 billion dollars.

Current Research and Development (R&D)

R&D Goals and Challenges

The characteristics of the required facility are summarized in Table 1. The major technical challenges have been identified:

- Achieving the very high reliabilities needed for the specified plant factor of 70%. A comprehensive international study is under way to collect and evaluate data from operating accelerator facilities to better understand the design and operational requirements for high availability.
- Keeping activation from beam losses low enough to minimize the need for remote maintenance of the accelerator. Although beam transport calculation losses would allow "hands-on" maintenance, the accelerator facility will be designed in such a way that remote maintenance is not precluded.
- Design and operation of a safe facility for the handling of lithium. A preliminary safety analysis indicates that the present design is adequate for safe operation.

The characteristics of this type of neutron source are relevant for any steady state D-T burning fusion device, which comprises virtually all magnetic fusion concepts. However, for inertial fusion, which is intrinsically pulsed, the changes due to neutron irradiation may be affected by the very low effective duty factor. Some combination of modeling and experiment with pulsed sources (e.g., spallation sources) may be needed to evaluate these effects.

Related R&D Activities

The Accelerator Production of Tritium project at Los Alamos National Laboratory and the Spallation Neutron Source project at Oak Ridge National Laboratory share much of the accelerator technology needs. Internationally, both the Japanese and the Europeans are examining some of the R&D issues related to IFMIF in their ongoing programs.

Recent Successes

- Completion of the International Conceptual Design Activity (REF)
- Completion of the engineering validation phase, which resolved several issues relating to the reliability and performance of the facility.

Budget

DOE-OFES: FY 1998 = \$320K and FY 1999 = \$180K.

Table 1. IFMIF characteristics

Neutron flux and volume	$>5 \text{ MW/m}^2$ and 0.1 L $>2 \text{ MW/m}^2$ and 0.4 L $>1 \text{ MW/m}^2$ and $>6.0 \text{ L}$
Particle	D+
Beam current	2@125 mA
Beam energy	32, 36, or 40 MeV
Beam spot	5 cm \times 20 cm
Plant factor	70%

Anticipated Contributions Relative to Metrics

Metrics

The irradiation volumes available at various flux levels are given in Table 1. Detailed evaluation² of material responses has been made by team members in Germany using newly developed neutron source models and detailed three-dimensional geometry. Table 2 shows a comparison of the IFMIF high-flux test module (HFTM) with outboard blankets of International Thermonuclear Experimental Reactor (ITER) and DEMO.

An important outcome of these and other calculations is that in spite of the high-energy tail of neutrons, all reactor-relevant irradiation parameters like helium/dpa ratio, hydrogen/dpa ratio, or recoil energy distribution are closely matched. For example, within the high flux volume of IFMIF, the displacements-per-atom and transmutation rates can be higher by a factor of 2–3 compared to DEMO conditions, but the important ratios of gas production to displacements-per-atom are nearly identical. This gives the possibility for accelerated testing and therefore a much faster material development, because an anticipated lifetime dose of 150–200 dpa can be achieved for selected key parameters within a few years.

Table 2. Comparison of the IFMIF HFTM with outboard blankets of ITER and DEMO. (All calculations are performed with MCNP code and extended nuclear data libraries for collided neutrons in iron.²)

Irradiation parameter	IFMIF HFTM ^a	ITER	DEMO
Total neutron flux [neutrons/(s·cm ²)]	$4 \times 10^{14} - 10^{15}$	4×10^{14}	7.1×10^{14}
Hydrogen production (appm/FPY)	1000–2500	445	780
Helium production (appm/FPY)	250–600	114	198
Displacement production (dpa/FPY)	20–55	10	19
Hydrogen/dpa ratio (appm/dpa)	35–50	44.5	41
Helium/dpa ratio (appm/dpa)	9.5–12.5	11.4	10.4
Nuclear heating (W/cm ³)	30–55	10	22
Wall load (MW/m ²)	3–8	1.0	2.2

^aDependent on the exact position inside the HFTM.

Near Term ~5 years

Before IFMIF can proceed with engineering design and construction, it is necessary to build and test a few key technology items to verify the operation of the main components of the accelerator, target, and test assembly systems. If funding were available for the international program, it would require about 4–5 years to complete the testing and evaluation phase.

Midterm ~10 years

Engineering design and construction is estimated to take 5–6 years following the testing and validation phase.

Long Term >10 years

Full operations could begin ~10 years from the start of the international program. As mentioned previously, test specimens simulating lifetime dose of 150–200 dpa can be achieved for selected key parameters within a few years. The facility would provide long-term support for the fusion materials program for 30 years or more.

Proponents' and Critics' Claims

Proponents regard the D-Li neutron source as an essential facility for the development of fusion-relevant materials and a necessary precursor to any high-fluence fusion plasma-based device. The accelerator technology is essentially in hand, advances in specimen miniaturization make the low volume acceptable, and the match to the spectral characteristics of a fusion system is adequate. Some critics claim that either a combination of existing neutron sources and computational modeling advances could eliminate the need for such a source; others claim that the use of a succession of plasma-based sources could be used to test both materials and components.

References

1. *IFMIF-International Fusion Materials Irradiation Facility—Conceptual Design Activity Final Report*, IFMIF-CDA-Team, M. Martone, ed., ENEA-RT/ERG/FUS/9611-Report, December 1996.
 2. E. Daum et al., *Neutronics of the High Flux Test Region of the International Fusion Materials Irradiation Facility (IFMIF)*, FZKA Report 5868, 1997.
-

T-11. TRITIUM SYSTEMS

Description

The reaction rate for deuterium-tritium (D-T) fusion is the fastest of all such reactions by a factor of about 80. Deuterium is plentiful and nonradioactive, but tritium does not occur naturally in any appreciable amount and is radioactive. Thus, tritium must be handled with meticulous care; it must be (1) properly contained to prevent personnel exposure, (2) handled with unique materials to prevent unwanted β -catalyzed reactions, and (3) processed using techniques with very high conversion factors.

Status

Tritium systems were first developed in the 1950s primarily for the world's nuclear weapons programs. Fusion has unique processing requirements, more stringent environmental concerns, and is unclassified, as opposed to much of the weapons work. Thus, in the late 1970s fusion-specific tritium systems R&D was initiated. The first facility built for this purpose was the Tritium Systems Test Assembly (TSTA) at Los Alamos National Laboratory. Later, tritium R&D facilities were built in Japan and Germany. The work performed at these facilities formed the basis for tritium-handling techniques required for the success of D-T experimental campaigns at the Tokamak Fusion Test Reactor (TFTR) and the Joint European Torus (JET). To date, good progress has been made to show that tritium can be handled safely and effectively on experiments of this nature and size.

Current Research and Development (R&D)

R&D Goals and Challenges

- Practical magnetic fusion power reactors will require unprecedented demands on the tritium systems. The first such reactor to be built [an International Thermonuclear Experimental Reactor (ITER)-like machine] will require the total nonweapons supply of tritium existing in the world to start up and operate. To minimize inventories, such a machine will require very rapid and as-yet undemonstrated recycling of the tritium within the fuel cycle. The larger inventories will necessitate better online tritium accounting techniques.
- Practical fusion power reactors may require advanced configurations such as falling liquid walls [inertial fusion energy (IFE)] and advanced blanket materials such as fluorine-lithium-beryllium molten salts (Flibe). While work to date on recovering tritium from ceramic blankets has progressed well, work on these advanced concepts has hardly begun. The goal would be to show that tritium can be effectively and safely recovered from such blanket materials, with particular attention given to demonstrating that materials of construction can adequately contain these blanket fluids, which may be corrosive and contain radioactive tritium.
- Tritium systems for handling configurations other than traditional magnetic fusion energy (MFE) machines [e.g., inertial confinement fusion (ICF)] have only begun to be considered. Overlap with presently understood systems will provide a basis for this, but there will be unique demands that will require tritium systems R&D and demonstration.
- Environmental and safety concerns continue to grow in importance. A traditional technique for preventing loss of tritium to the environment from effluent streams is to convert all hydrogen isotopes to water, collect the water, and bury it. With heightened concerns for the environment, this technique and related ones have become increasingly problematic. Methods need to be developed to avoid the generation of tritiated water, which is about 20,000 times more hazardous than elemental tritium. Rather, the tritium should be recycled directly within the processing system. Also, cost-effective methods for recycling tritium from dilute tritiated water streams (e.g., contaminated cooling water) need to be developed.

Related R&D Activities

The processing and safety of tritium systems, with a major focus on magnetic fusion, has taken place as part of a U.S. Department of Energy (DOE)/Japan Atomic Energy Research Institute (JAERI) collaboration. Until recently this collaboration was conducted primarily between TSTA in the United States and the Tritium Processing Laboratory (TPL) in Japan. This interaction has been expanded to include tritium decontamination and decommissioning (D&D) activities at TFTR. The ITER project also supported some tritium systems R&D. Little activity in tritium processing R&D is taking place elsewhere within the United States.

Recent Successes

The most significant development in tritium processing in recent years has been the palladium membrane reactor (PMR). The PMR provides the hitherto unavailable capability to recover tritium from substances such as water and methane with high efficiency and without generation of further waste. This research led to the discovery that permeators can be used with low permeate pressures for nearly complete separation of hydrogen isotopes from other gases, which may lead to cleanup systems that avoid the generation of tritiated water. Progress has been made in the development of self-assaying components, tritium systems D&D, and tritium safety.

An interesting spin-off of this research has applicability in hydrogen economy endeavors. The research has shown the capability to reform various hydrocarbons including alcohols and gasoline into hydrogen with high conversion in a single processing step, while in industry it may take as many as eight steps. The hydrogen can, in turn, be used to feed a fuel cell that powers a vehicle or to make ammonia as a precursor to fertilizers.

Budget

During the 1980s the funding for tritium systems development in the United States was about \$4M/year with half from DOE and half from Japan. In recent years this funding was reduced to about \$2M/year. For FY 1999, with TFTR included in the U.S.-Japan collaboration, this funding is at \$3.2M with \$1.5M from Japan and the remainder from DOE.

Anticipated Contributions Relative to Metrics

Metrics

The qualitative metric for tritium systems development is to adequately demonstrate that the tritium systems are feasible for fusion systems of interest, both in terms of effectiveness (i.e., valuable tritium is not lost) and in terms of safety (i.e., personnel and the environment are properly protected).

Near Term ~5 years

Presently tritium systems R&D is focused on (1) D&D with special emphasis on learning from the TFTR D&D activities, (2) studying system responses to off-normal events, (3) online inventory measurements, and (4) tritium materials interactions. Technologies developed in the United States are being deployed at the JET Active Gas Handling System.

Midterm ~20 years

In this time frame it is anticipated that work will be required on recovering tritium from advanced blanket materials such as Flibe and liquid lithium. Tritium systems for fusion configurations such as ICF and ITER-scale machines will need to be developed and demonstrated. In this time frame, and possibly earlier, systems that do not rely on the generation of tritiated water need to be developed, and cost-effective methods for decontaminating dilute tritiated water will be needed.

Long Term >20 years

Activities will be driven by the unique needs of fusion-powered electric generating stations such as large-scale, high-availability operations; tritium breeding; tritium accounting and safeguards; large-scale, international tritium shipping and receiving; and, of course, tritium safety.

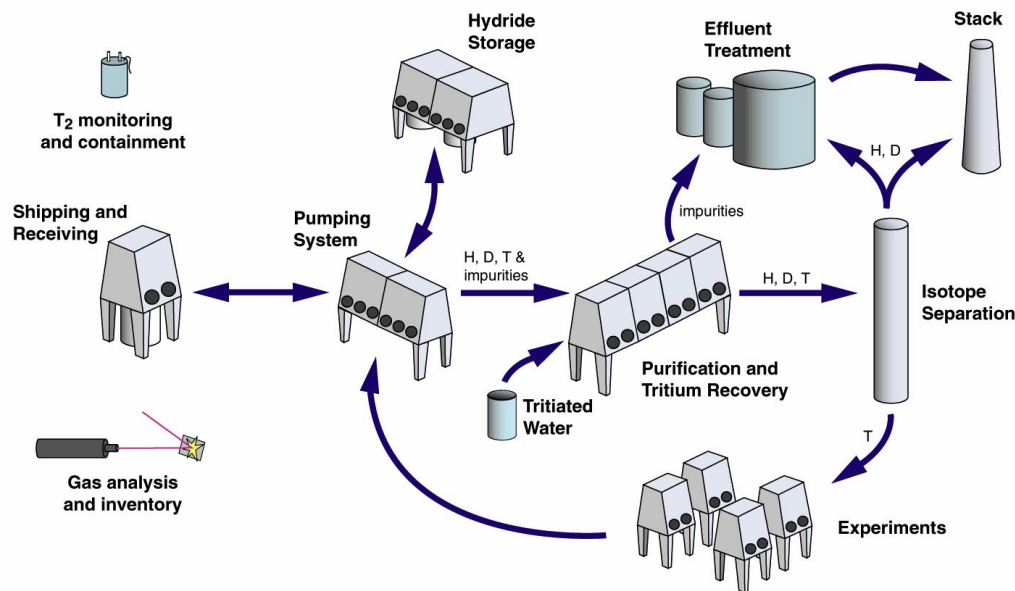

TSTA integrates all tritium processing technologies

Proponents' and Critics' Claims

Claims regarding tritium systems run a wide gamut. Some claim that tritium systems development has run ahead of other areas in the overall fusion development. Others note that inadequately dealing with even small amounts of tritium can lead to very adverse consequences such as the recent dismissal of the entire Brookhaven National Laboratory management team.

T-12. REMOTE MAINTENANCE

Description

In a fusion reactor, soon after deuterium-tritium (D-T) operation begins, the confinement wall structure becomes highly radioactive because of activation by fusion neutrons. For example, the estimated gamma radiation level inside the International Thermonuclear Experimental Reactor (ITER) is 3×10^4 Gy/h, about 2 orders of magnitude higher than encountered in fission reactors of comparable power. Such an intense radiation environment precludes human access near the reactor, making it necessary for all in-vessel maintenance work to be done remotely. Examples of anticipated remote maintenance tasks are (1) inspection and metrology of plasma-facing components (PFCs); (2) repair and replacement of major components such as divertor modules, blanket modules, ion cyclotron heating (ICH) antenna modules, and other PFCs; and (3) cutting and ultra high vacuum quality welding of the structural wall and service pipes. The fusion remote handling (RH) research and development (R&D) is aimed at accomplishing tasks that are applicable for both magnetic and inertial fusion systems. The figure illustrates the Blanket Test Platform at the Japan Atomic Energy Research Institute (JAERI), set up for testing RH of tritium breeding blankets in ITER. In this test, a semicircular monorail section is deployed through a horizontal port with radial supports at 90° intervals (a full circular rail of the same size is planned for ITER). A remotely operated arm, mounted on the rail, is used to transfer the 4-ton blanket modules with 2-mm positioning accuracy.

Status

To date, the RH work in experimental fusion machines has been primarily in the Joint European Tours (JET). The RH requirements in JET have been moderate enough to permit the use of state-of-the-art technology, relying heavily on human-machine interface. Conversely, the RH requirements for ITER have been considerably more difficult, needing significant R&D. In the United States, because of budget cutbacks, the RH R&D work has been limited to two areas: (1) remote in-vessel inspection and metrology and (2) remote cutting and welding of thick plates (vacuum vessel). Japan and EU carried out a large part of the RH R&D activity for ITER.

Current Research & Development (R&D)

R&D Goals and Challenges

The U.S. work on remote metrology and viewing has resulted in the development of a frequency modulated (FM) Coherent Laser Radar (CLR) device, capable of measuring ranges up to 22 m with <0.1-mm precision. The device is also able to render picture-quality images of surfaces by scanning the surfaces and utilizing the various range measurements. Acousto-optic scanning techniques have also been developed to obtain high scanning rates (16,500 points/s) with no moving parts. In the remote cutting/welding area, the U.S. work has resulted in the development of a compact system for remote cutting and welding of thick plates (40-mm thick, simulating the ITER vacuum vessel). The system uses the Narrow Gap TIG process for minimum distortion, high-quality welding and the MIG process for cladding or overlay. Two systems were simultaneously used to weld the 40-mm-thick walls of a partial mockup of the ITER vacuum vessel field joint.

Related R&D Activities

Robotics and Intelligent Machines (RIMs) are used in a wide range of applications such as characterization and inspection in manufacturing, dismantlement, and decommissioning of hazardous systems and surveillance and monitoring of facilities. The RIM R&D in each of these areas is directed at reducing time and cost, increasing quality and reliability, and improving human safety by reducing manpower and exposure. A roadmap for RIM R&D, covering the next two decades, has recently been prepared at DOE's initiative.

Recent successes

RH operations have successfully been carried out in JET. The two large demonstrations, involving the blanket and the divertor modules have verified the ITER blanket and divertor RH concepts. The FM laser-radar-based metrology/viewing device concept has met all the performance specifications of ITER. The development and testing of the remote cutting and welding devices developed by the United States (for thick plates) and Japan (for pipes) have been successful.

Budget

The U.S. budget in the RH area for FY 1999 is \$430K (\$200K for remote in-vessel metrology/viewing and \$230K for remote cutting/welding of thick plates).

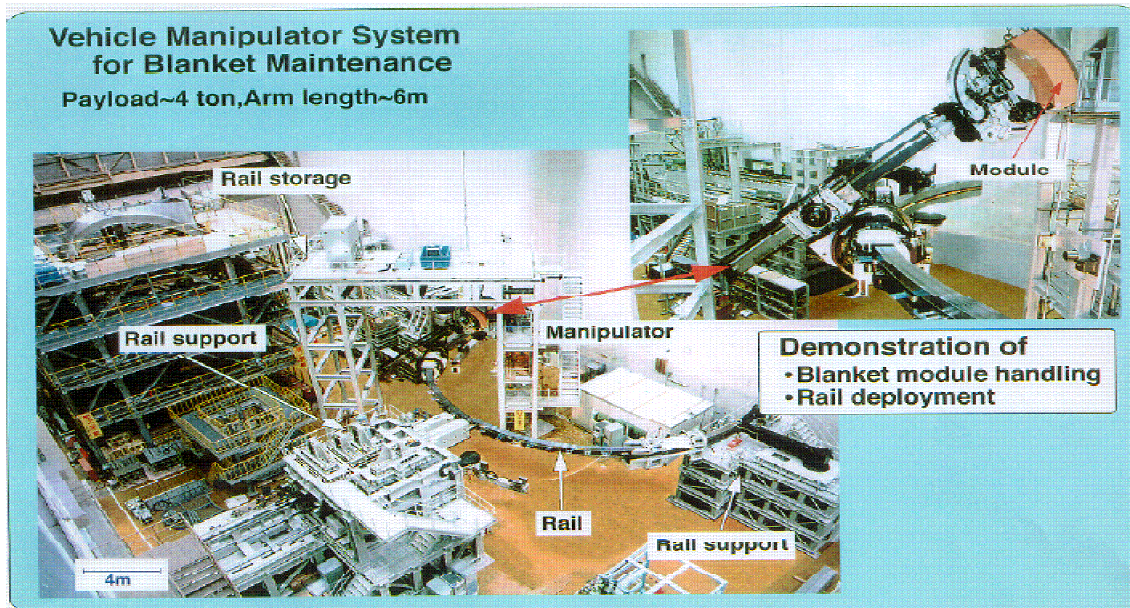

Anticipated Contributions Relative to Metrics

Metrics

The RH area metrics are task time, robustness and reliability, human exposure, and cost.

Near Term < 5 years

The plan is to pursue collaboration, at home and abroad, to continue the development of the remote metrology/viewing system. In the area of remote cutting and welding, the near-term goal is to demonstrate the operation on a full-scale ITER vacuum vessel prototype sector, located at JAERI.

In the remote metrology/viewing area, the challenges are to obtain fast scanning rates, while maintaining submillimeter accuracy in range measurement. A probe configuration, complete with laser optics and scanning arrangement and compatible with fusion reactor in-vessel environment, needs to be fabricated and tested. In the remote cutting/welding area, robotic welding and cutting have been demonstrated, but fully robotic operation, including handling of splice plates and inspection, must still be developed. In the divertor RH area, the hot cell refurbishment of the divertor parts has not been fully tested. Also, further work is necessary to reduce costs, increase reliability, establish rescue plans if components fail, and improve human interface. Further R&D is also required for dexterous servomanipulation of heavy payloads. The challenge is to manipulate payloads of about 10 tons with positioning accuracy of 1 mm. Sophisticated control algorithms have to be developed and implemented to achieve this goal. Although this is a generic RH R&D area, it is particularly important in the fusion context because of the high degree of complexity, large size, and high placement accuracy needed for fusion applications. A proposed U.S. collaboration with Japan (approved by Japan) in dexterous manipulation of heavy payloads can leverage on the large RH test facility (shown in the figure above) at JAERI.

Midterm ~20 years

Build and test reactor-relevant RH systems.

Long Term >20 years

Provide improvements to the RH systems in the metrics mentioned above.

Proponents' and Critics' Claims

Proponents claim that advanced R&D on RH is necessary to have the required technologies available when they are needed. Critics claim that RH can only be developed in conjunction with a specific machine design (such as ITER) and should be considered as an integral part of such design efforts, not as a separate stand-alone program.

T-13. MFE SAFETY AND ENVIRONMENT

Description

One of the main reasons for pursuing the development of fusion energy is the prospect that its safety and environmental characteristics will be better than those of other energy technologies. Although the safety and environmental advantages of fusion have long been emphasized, these benefits do not come automatically. Tritium, neutrons, and neutron-activation products in fusion reactors present radiological hazards. In addition, nonnuclear risks relative to chemical hazards, magnetic fields, cryogen, and vacuum also must be considered. Materials choice is a key factor in influencing the overall safety and environmental attractiveness of fusion. In fusion, the materials can be decoupled from the energy source by design. Thus, safety-conscious selection of materials can result in minimization of toxic materials, activation product and tritium inventories, and stored energies. Further, the use of low-activation materials will allow fusion components to be recycled or disposed of as low-level waste and not be a burden to future generations. Finally, implementation of safety and environmental requirements early in the design process can also improve the safety and environmental attractiveness of fusion.

Status

Excellent progress has been made in demonstrating the safety and environmental potential of fusion. In the 1970s, examination of the activation product and tritium hazards associated with fusion and reactor design studies featuring low-activation materials had just started. In the 1980s, fusion's radiological and toxicological hazards were being more accurately characterized; experimental data on the behavior of radiological and hazardous materials and the energy sources that could mobilize those materials were being generated; and more sophisticated analytical models were being developed and applied to accident analysis and waste characterization. In the 1990s, the advent of the International Thermonuclear Experimental Reactor (ITER) focused the world's safety and environmental activities in support of obtaining regulatory approval for this one-of-a-kind fusion facility. Safety and environmental design criteria were developed, and significant effort was devoted to safety integration in the design process. Research and development (R&D) activities were focused to support ITER safety issues that needed to be addressed as part of the safety analysis. A comprehensive safety analysis was performed using state-of-the-art safety analysis tools, which indicated that ITER would not require public evacuation under worst case accidents. The scope, depth, and rigor of the ITER safety effort were unprecedented for fusion.

Current Research and Development (R&D)

R&D Goals and Challenges

The major goal is to demonstrate the safety and environmental potential of fusion by (1) avoiding any need for off-site public evacuation during worst case accidents and (2) minimizing the amount of radioactive waste that would pose a burden for future generations. To support this goal, the mission of the R&D program follows:

- Understand the behavior of the largest sources of radioactive and hazardous materials in a deuterium-tritium (D-T) fusion machine.
- Understand how energy sources in a fusion facility could mobilize those materials during accident conditions.
- Develop integrated state-of-the-art analytical tools and computer codes needed to demonstrate the safety and environmental potential of fusion.
- Develop design criteria for radioactive and hazardous waste minimization and evaluate recycle/reuse potential of fusion materials.
- Work with fusion design activities to address safety and environmental concerns early in the design process.

Related R&D Activities

- Conduct coordinated environmental and safety R&D through the International Energy Agency (IEA) collaboration on Environment, Safety, and Economics
- Support ITER engineering design activities (EDAs) safety and environmental R&D.

Recent Successes

- Development of functional safety and environmental requirements for fusion facilities in the Department of Energy (DOE) Fusion Safety Standards.
- Safety activities in the ITER EDA (see above status).

Budget

FY 1998 = \$2.2M, and FY 1999 = \$1.75M.

Anticipated Contributions Relative to Metrics

Metrics

- Develop fusion designs that meet the no-evacuation guideline of 10 mSv (1 rem) under worst case accidents.
- Develop fusion designs to minimize generation of waste posing a burden to future generations.

Near Term ≤5 years

- Continue safety R&D on tokamak dust and solid plasma-facing components to understand and quantify safety margins associated with these materials.
- Continue safety R&D on how energy sources in fusion can mobilize radioactive materials under accident conditions.
- Begin safety R&D on new and advanced fusion materials and coolants being considered in the program (e.g., molybdenum alloys, tantalum alloys, Flibe, tin–lithium).
- Develop criteria for recycle and reuse of fusion materials to be used in fusion conceptual design studies.
- Upgrade safety computer codes to deal with liquid surface concepts being considered for some fusion designs.
- Assess safety and environmental issues associated with high-power-density fusion designs and other alternate confinement concepts.
- Integrate safety lessons learned from ITER into fusion conceptual systems studies.
- Continue international safety and environmental collaborations.

Midterm ~10 to 20 years

- Support program development of both magnetic and inertial Next Step options to meet safety and environmental goals (e.g., safety R&D, safety/design integration, and safety analysis needed for regulatory approval of the facility).
- Demonstrate feasibility of recycle and reuse of fusion material(s) to demonstrate safety and environmental potential of fusion.
- Continue contributions to fundamental science.

Long Term >20 years

- Support safety and environmental activities needed to develop a fusion power plant for deployment in second half of next century.

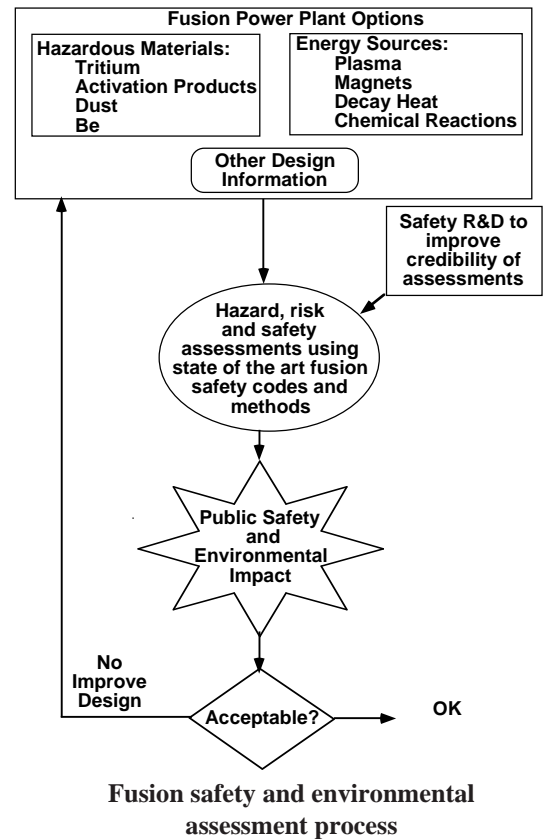

Proponents' and Critics' Claims

Proponents claim that the safety and environmental characteristics of fusion are superior to those of other energy technologies both in terms of worst case accidents and in waste generation. Critics state that fusion is no better than fission from the safety perspective. The positive environmental attributes claimed about the technology have yet to be proven.

T-14. IFE SAFETY AND ENVIRONMENT

Description

Safety and environmental (S&E) issues will be one of the key factors in the success of fusion energy. Under the S&E umbrella sit routine releases of radioactive materials (e.g., tritium), health consequences resulting from accidental large releases, and radioactive waste management. It is a commonly held belief that fusion offers significant S&E advantages over fission, but this is not necessarily the case. For fusion to achieve its full potential for S&E advantages, it is essential that analyses are performed early in the design of any facility so that wise choices can be made and that lessons learned from previous designs are incorporated. It is also crucial that interactions between the different S&E areas are included, understood, and used to the greatest possible extent.

Status

Good progress has been made in recent years in developing advanced radionuclide inventory codes and activation cross section libraries. An experimental program to measure the volatility of some of the candidate structure alloys provided safety analysts with data needed to estimate potential off-site doses during accidents. Adequate codes are available for calculating doses from (1) routine operational effluents (AIRDOS-EPA), (2) public exposure during an accident (MACCS2), and (3) routine exposure to workers. Additional progress is needed in the following areas:

- Activation cross section libraries will continue to require further attention.
- Experimental volatility data exist for only a few materials.
- Radionuclide release calculations should account for deposition and depletion within the facility.
- Development of the tools needed to accurately predict the transport of radioactive dust during an accident or routine maintenance activities is needed.
- Probabilistic risk assessment (PRA) needs to be developed/adopted throughout the fusion community.
- Less severe accidents, which may occur with greater frequency, need to be considered in more detail.
- Tritium management and target fabrication in particular need to be further developed.
- Limits for worker exposures during maintenance activities need to be further developed.
- Development of fusion-specific regulations for the reuse, recycling, and disposal of radioactive fusion materials is needed.

Current Research and Development (R&D)

R&D Goals and Challenges

- Maintain risk to the public and maintenance personnel as low as reasonably achievable (ALARA).
- Meet the no-evacuation dose criterion.
- Expand on previous mobilization experiments.
- Select materials that will reduce radioactive and hazardous inventories.
- Show that tritium inventories can be managed safely with minimal routine and accident releases.
- Adopt and build on PRA methods that have been developed by the fission community.
- Reevaluate the waste form behavior indices used in 10 *Code of Federal Regulations* (CFR) 61 in relation to fusion waste.
- Accurately account for the transport of radioactive dust.

Related R&D Activities

- Radionuclide mobilization experiments will continue at Idaho National Engineering and Environmental Laboratory (INEEL) facilities.
- Benchmarking of radionuclide inventory codes will continue with the RTNS-I and FNS facilities.
- Credible accident scenarios (including less severe ones) will be developed by Lawrence Livermore National Laboratory (LLNL) and INEEL.
- Radioactive dust transport codes will continue to be developed by the University of Wisconsin, and supporting experimental work using the Wisconsin Shock Tube is being planned.
- Coordination with the chamber and radiation-resistant materials development activities is essential.

Recent Successes

- INEEL radionuclide mobilization data show that assumed release fractions are conservative.
- International benchmarking activities show that major radionuclide inventory codes are in good agreement.
- MACCS2 code allows detailed off-site dose calculations to be performed for most radionuclides of interest.
- Recent design studies show that use of thick-liquid protection schemes reduces waste disposal needs and makes use of some traditional materials possible.
- Recent work indicates that pulsed activation effects have been adequately addressed.
- Decay heat data have been verified through integral experiments using 14-MeV neutron sources.
- Initial hydrodynamic calculations have studied short time-scale dust transport out of the X-1 chamber.

Budget

The FY 1999 budget will be approximately \$100K. FY 2000–2002 budgets need to increase to approximately \$500K to support additional mobilization experiments and begin updated power plant designs that incorporate the lessons learned.

Anticipated Contributions Relative to Metrics

Metrics

- Off-site doses resulting from a worst-case credible accident should be less than 1 rem to eliminate the need for an evacuation plan.
- Designs should aim to limit wastes to those suitable for reuse, recycling, or disposal via shallow land burial.
- Where possible, thick-liquid protection schemes or low-activation materials should be used.
- Occupational exposures should be at or below the levels observed in today's "best-experience" fission plants.
- Routine releases of tritium and activation products must be shown to be benign.
- Designs should use multiple physical barriers to minimize releases of radioactive and/or hazardous inventories.

Near Term <5 years

- Radionuclide mobilization data will be obtained for key materials.
- Credible accident scenarios will be developed for several designs.
- Development of tools needed to simulate transport of activated dust will be continued.
- Experiments on Z and RHEPP to characterize dust will be carried out.
- Waste management activities will be redirected to take advantage of the favorable waste form behavior indices associated with fusion waste.
- The ramifications of reuse and recycling of fusion waste will be examined.
- Tritium management and target fabrication will be given greater attention.
- Current designs will be modified to incorporate lessons learned; new designs will be developed.

Midterm ~20 years

- Experiments fielded on the National Ignition Facility (NIF) and X-1 facilities will be of great importance for validation of computer codes (e.g., radionuclide inventory and cross sections, X-ray ablation, isochoric heating within blankets and thick-liquids, and fusion gain curves).
- Recycling of some radioactive wastes will be shown to be practical.
- The superior S&E advantages of advanced concepts using tritium-lean targets and alternate fuel cycles will be demonstrated.
- Occupational releases, occupational exposures, and maintenance requirements will all be better understood once experience has been gained in the operation of NIF, X-1, and an Engineering Test Facility.
- Fast closure valves for control of radioactive dust transport will be developed.
- S&E work will be entirely performed using probabilistic risk analysis (PRA) methods; comparisons to alternate technologies will be made.

Long Term >20 years

- Advanced designs will be shown to be "inherently safe" with radionuclide inventories that are low enough such that the basic safety criteria can be met even without mobilization or transport analyses.
- Waste management activities will show that many of the "wastes" are actually valuable and that others may be successfully reused.
- Activated dust containment will be demonstrated in a high-yield environment.
- The issue of the risk from exposure to low levels of radiation will be resolved.

Proponents' and Critics' Claims

Proponents claim that fusion has inherent S&E advantages over fission such as the freedom to select materials, no possibility of achieving an uncontrolled chain reaction, and lower decay heat. Advanced fuel cycles and concepts will have extremely low accident and waste consequences in addition to lower routine releases.

Critics state that anything nuclear is bad, because any level of radiation dose is damaging. The waste management challenges are too great to be overcome. Maintenance requirements are too extreme and will require excessive worker exposures.

T-15. IFE LIQUID-WALL CHAMBERS

Description

An inertial fusion energy (IFE) target releases energy in neutrons, X-rays, and target debris. Chambers transfer this energy to a coolant while protecting the final-focus system and restoring conditions for the subsequent shot. Liquids can provide renewable target-facing surfaces, invulnerable to X-ray and neutron damage. Among several candidates, the nonflammable molten salt Flibe (Li_2BeF_4) has received the most extensive study, because of its very low vapor pressure and excellent neutron-shielding and tritium-breeding properties. One-half-meter line-density of Flibe provides sufficient neutron shielding for stainless steel structures to reach a 30-year lifetime at 1 GW(e) and qualify for shallow land burial, reducing or eliminating the need for materials neutron irradiation testing. Two primary liquid-wall options exist:

- **Thick-liquid jets.** Free liquid jets injected by stationary and oscillating nozzles create a pocket around the ignited target, shielding all chamber structures and allowing very compact geometry and short focus standoff distance. Higher availability comes from eliminating periodic replacement of structural components in high-flux regions.
- **Wetted walls.** Low-mass flow-guiding structures, either fiber blankets or tubes, control liquid geometry. Liquid films weeping through the blanket fabric or fan jets from nozzles provide a thin renewable layer for X-ray ablation. Shock loading of flow-guiding structures by neutron heating requires a larger chamber than the thick-liquid option.

Flibe liquid-wall shielding automatically meets tritium breeding goals. The surface area for debris condensation can be made arbitrarily large by injecting small liquid droplets; analysis indicates that around 1.6% of total coolant flow is needed as droplets at 1 GW(e), for a thick-liquid chamber. Design choices depend strongly on the driver type:

- **Heavy ions (HIs).** Liquid walls are the *baseline* chamber strategy for HI-IFE. Thick liquid will be selected over wetted walls as the baseline, if liquid-hydraulics issues resolve favorably, because the shorter focus-magnet standoff with thick-liquid jets (<5 m vs 10 m) improves focusing and reduces driver energy by around 30%.
- **Lasers.** Wetted walls provide an *option* to the baseline dry-wall chambers for laser IFE. Feasibility involves accommodating the large driver solid angle required for direct drive and protecting final optics from condensation of ablation debris. Advanced fast-ignition targets could potentially adapt to thick-liquid protection.

Status

Conceptual designs exist for wetted-walls (OSIRIS, LIBRA, HIBALL, KOYO) and thick-liquid (HYLIFE). Experiments and model development have refined the understanding of major liquid-wall target-chamber phenomena.

Current Research and Development (R&D)

R&D Goals and Challenges

Liquid protection can work below 1 Hz using gravity clearing of liquid debris. To avoid beam switching to multiple chambers, current R&D focuses on clearing at 4 to 10 Hz. Key chamber phenomena occur over widely ranging time scales: target drive, neutron heating, and X-ray ablation over tens of nanoseconds; ablation and target debris venting over tens of microseconds; and condensation and liquid hydraulic response over tens of milliseconds. Coupling between phenomena with similar time scales can be strong, requiring integrated experiments. Only the integrated effect of fast phenomena couples to slow phenomena, that is, only the impulse load from ablation and venting affects slower liquid hydraulic motion. Liquid-wall R&D can take advantage of this temporal decoupling to avoid full-scale, integrated liquid-wall tests before construction of the first ignition-class, 30 MJ \times 10 Hz = ~300 MW, average-power Experimental Test Facility (ETF) using liquid walls.

Related R&D Activities

- **NIF/Z/X-1.** These Defense Program funded facilities will provide sufficient energy for integrated studies of ablation, venting, and condensation, including secondary-radiation-induced ablation, real-gas effects, and structural loading.
- Activities include magnetic fusion energy (MFE) liquid-wall protection, target injection and tracking, final optics/magnet R&D, and target X-ray/debris emission.

Recent Successes

- Shielding and activation calculations have confirmed the effectiveness of liquid shielding of stainless steel chamber structures, permitting >30-year lifetime and shallow land burial; MFE liquid-wall studies have found new coolants.
- Coupled 2-D gas dynamics and 1-D X-ray ablation codes have modeled ablation, venting, and structural loading. Calculations show that venting rates are sufficiently high to support rapid debris condensation; impulse loading to thick liquids is sufficiently small so the bulk-liquid velocity imparted is low.
- Liquid hydraulics experiments have demonstrated smooth stationary jets that can form grids for final-focus beam-line shielding; demonstrations of oscillating jets are under way; efforts are also under way to make even smoother jets.
- Gas-gun indirect-drive target injection experiments have demonstrated the accuracy required for HI-IFE.
- Major supporting technologies—tritium containment and recovery, secondary steam generators, rapid condensation on droplets, final-focus neutron and gamma shielding—have received preliminary study.

Budget

DOE–OFES: FY 1998 = \$325K, and FY 1999 = \$460K.

Anticipated Contributions Relative to Metrics

Metrics

Liquid-wall chambers are inexpensive (i.e., 6% of capital cost for HYLIFE-II). Metrics thus focus on minimizing major plant costs by minimizing driver energy through optimal coupling to targets (focal magnet standoff <10 m for heavy ions), by achieving high repetition rates (>4 Hz) to avoid beam switching to multiple chambers, by achieving modest coolant-pumping power (<10% recirculated), by obtaining high availability (>80 %), and by keeping operating and accident radiation doses low.

Near Term ≤5 years

The major near-term liquid-wall R&D goal is resolution of remaining *feasibility* questions, providing confidence in prospects of long-term success to support the decision to proceed with integrated research experiment(s) (IREs) for HI and/or laser drivers. The R&D focuses on liquid-droplet, target/ablation-debris clearing.

- Systems studies. Extend the HYLIFE, OSIRIS, and LIBRA (HIs) and KOYO (lasers) system studies to incorporate innovations and ongoing advances in modeling tools.
- Liquid-jet hydraulics. Refine capabilities to generate high-quality stationary and oscillating liquid jets and to model and control momentum transfer, shock propagation, and droplet generation in heterogeneous liquid structures.
- Wetted-wall hydraulics. Confirm methods for forming liquid films on fabric surfaces, generating liquid fan jets and clearing droplets, modeling shock effects on flow-guiding structures, and modeling turbulent liquid surface renewal.
- Ablation/venting/condensation. Refine modeling tools, supported by experiments, for key phenomena. Develop diagnostics capable of measuring transient surface pressure loading and temperature and debris density and velocity, for future chamber-clearing experiments in high-energy facilities (NIF, Z, and/or X-1).
- Superconducting magnet shielding and thermal response. Conduct computational neutronics shielding studies, small-angle scattering cross section experiments, and superconducting magnet thermal design for pulsed heating.
- Laser final optics protection. Control ablation debris migration to transparent vacuum interface.
- Flibe chemistry, corrosion, EOS and tritium recovery. Conduct studies of specific Flibe thermophysical and chemical properties relevant to IFE and MFE coolant use (Japanese collaboration will be valuable in this area).

Midterm ~20 years

Success would be experimental validation of models required to extrapolate to prototypical chamber conditions, coupled with integrated system designs meeting clearing rate and other metrics. Presuming that thick liquid will be found viable, during this period three major experimental activities occur to provide *engineering-design* capability:

- Integrated ablation/venting/condensation. Integrated experiments on NIF, Z, and/or X-1 in minichambers scaled to prototypical energy densities, to rigorously confirm detailed structural loading and debris condensation models.
- Integrated liquid hydraulics experiments. Integrated experiments in a liquid-hydraulics test facility, using water in a vacuum environment, to demonstrate liquid-pocket formation, destruction with scaled explosive charges, and pocket reestablishment. Laser beams along the beam paths confirm droplet clearing after pocket disruption.
- Beam propagation experiments. IRE study of the effects of background gas density and residual liquid droplets on heavy-ion/laser beam propagation under prototypical chamber conditions.

Success would allow engineering design of the first >4-Hz molten-salt liquid-wall chamber for the ~300-MW ETF.

Long Term >20 years

With adequate budgets, liquid-wall target chambers operating at 4 to 10 Hz can be made available for the ETF and subsequent IFE demonstration and commercial fusion power plants.

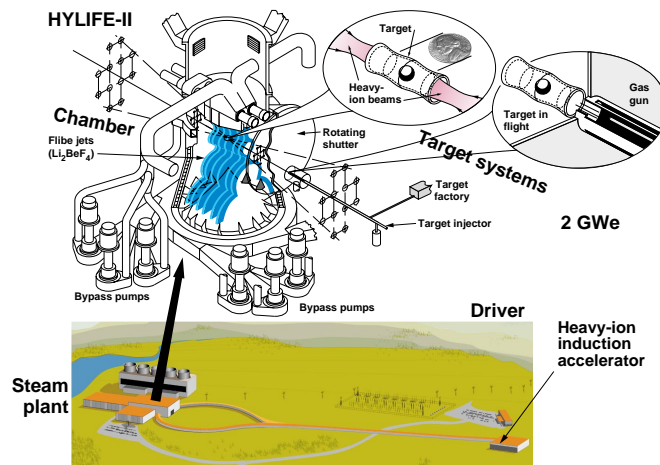

Liquid-jet protected fusion chambers for long lifetime, low cost, and low environmental impact.

Proponents' and Critics' Claims

Proponents claim that thick-liquid walls can reduce the need for expensive materials testing programs and with their compact geometry can provide major advantages for capital cost, availability, heat removal, and tritium control and recovery. Critics claim that debris condensation and droplet clearing rates will prove too low for high repetition rates; for HIs, that background gas densities will be too high for beam propagation; and for lasers, that ablated liquid will condense on the transparent vacuum interface.

T-16. DRY WALL CHAMBERS

Description

The energy emanating from an inertial fusion energy (IFE) target is in the form of neutrons, X rays, and ions. Unlike liquid wall chambers, where the X-ray and ion energy can be dissipated by evaporation, a dry wall chamber must conduct and convect this energy through the first wall (FW) to cooling materials in the blanket. Dry wall chambers can be used with direct- or indirect-drive lasers or ion beams, whereas liquid wall protected chambers are more appropriate for indirect-drive systems. The FW in dry chambers can be metallic or ceramic. Recently, graphites and SiC have been considered because of their low activation characteristics.

FW Protection (from high flux of X rays and ions)

- A protective fill gas can block the X rays and the ions and then reradiate the energy to the FW over a longer time scale.
- Another way to reduce the instantaneous heat flux on the FW is to make the chamber very large (e.g., a Westinghouse study in the mid-1970s).
- Protection from ions can be provided by a magnetic field, which can deflect or stop the ions before they impact the FW. It has even been suggested that direct energy conversion can also be accomplished in this way. This scheme does not stop the X rays.
- Another conceptual design study has used a solid breeder material directly exposed to the target emanations. In this design, a large SiC drum was rotated about its axis while a solid breeder material flowed on the inside of the drum in full view of the target explosion (CASCADE—the thermal conversion efficiency was 55%). This scheme requires indirect drive with either lasers or heavy ions coming in on either end of the drum.

FW Designs

Low activation materials for the FW such as graphite or SiC may be used to reduce activation. Such materials can also have high-temperature capabilities, opening the possibility for high-energy conversion power cycles. A low-pressure blanket system may allow granular solid breeder materials flowing through the blanket by gravity.

Status

There have been three conceptual design studies of dry wall chambers using graphite or SiC walls with flowing granular solid breeder materials to remove the energy (SOLASE, SOMBRERO, and SIRIUS-P) (see figure). As an example, SIRIUS-P had a 6.5-m radius chamber, a fill gas of xenon at an atom density of $1 \times 10^{16} \text{ cm}^{-3}$, and utilized a KrF laser at 0.25- μm wavelength. The electric power output was 1000 MW, using a target yield of 365 MJ, which consisted of 274 MJ in neutrons, 20.5 MJ in X-rays, and 71.6 MJ in ions. Radiation hydrodynamic codes were used to determine thermal and pulse loading on the chamber wall. In this case, the chamber was made of a four-dimensional weave of graphite. The peak heat flux was 0.118 MW/cm², producing a temperature rise on the FW of 574°C over the steady-state temperature of 1400°C, and the impulse on the FW was 1.89 Pa-s, producing a 0.01-MPa pressure.

Current Research and Development (R&D)

R&D Goals and Challenges

The critical issue for dry wall chambers is the protection of the FW from the X rays and ions. However, before the problem can be analyzed, the target spectrum must be known. The target spectrum depends on the target materials and geometry. The type and amount of fill gas then has to be traded against what the chamber can tolerate before laser gas breakdown will occur, and whether a cryogenic target can be launched through it without picking up debris or excessive heating.

- Laser gas breakdown: Near the target, the high energy density can break down the fill gas (wavelength dependent), causing defocusing and loss of energy. Experiments to test laser breakdown in fill gasses can be readily performed today on existing KrF lasers such as NIKE. The degree of breakdown can be measured as a function of gas density and laser beam intensity.
- Target propagation: A balance has to be struck between the amount of gas that will provide protection for the FW while allowing the target to be delivered to the chamber intact. Experiments can be designed to test this.
- First wall and blanket issues: There are material issues of the FW such as thermal and structural effects from radiation damage. Pulsed radiation damage produces different effects from steady state. However, pulsed radiation damage may be simulated with steady-state sources. The availability of a 14.1-MeV neutron source is still a long way away. Simulating pulsed X rays and ions with the correct energy and mix is very difficult. The effects of radiation damage on graphite materials are needed to determine thermal conductivity, which degrades with radiation. The heat transfer coefficient in granular moving solid breeders can be determined experimentally but without the synergistic effects of neutrons. Blankets utilizing moving granular solid breeders have a set of issues related to them, which have to do with particle erosion and attrition.

Related R&D Activities

There are other R&D activities in the magnetic fusion energy (MFE) program that can benefit issues of dry wall reactors. These are in the areas of high heat flux experiments and radiation damage to materials. Future experiments on the National Ignition Facility (NIF), PBFA, and X-1 will provide target spectrum information, validating computer codes developed for IFE target chambers.

Recent Successes

- All the R&D work that has gone into the design of the dry wall chamber for NIF has added to the knowledge and understanding of dry wall issues. The design of the graphite wall chamber SOMBRERO has also been useful in that regard.
- Additionally, there has been tremendous progress in the development of codes for studying the hydrodynamic effects of target emanations on chamber walls (BUCKY, TSUNAMI, and ABLATOR).

Budget

DOE/IFE/technology: FY 1998 = <\$1M; FY 1999 = \$2.2M (proposed).

Anticipated Contributions Relative to Metrics

Metrics

It is hoped that dry wall chambers using direct-drive KrF laser beams and flowing granular solid breeding materials can show promising reactor plant capabilities with the cost of electricity in the 55–65 mills/kWh range. Such a design would have laser energy of 3.4 MJ, a target gain of 118, and a repetition rate of 6 Hz. The chamber would also satisfy the main safety goals for low-level waste disposal, limiting public dose to a maximum exposed individual from routine operation to 5 mrem/year and producing a whole-body early dose from a maximum credible accident below 1 rem.

Near Term <5 years

Laser gas breakdown and target delivery through a fill gas can be answered experimentally in this period of time. Slowing down or stopping target emanations by a fill gas will continue to be studied analytically with experimental verification provided at a later date. This is also true of magnetic protection. This scheme may be best used with direct-drive targets that emit only a few very hard X rays, but this has not been tested in any conceptual designs yet. Material issues such as particle erosion and attrition can also be determined in simple experiments, but without the synergistic effects of neutrons and microexplosions. Bench top experiments on the performance of multiweave graphites and SiC under repeated pulsing can also be determined. Experiments to determine heat transfer coefficients in moving bed granular solid breeders can also be performed. Injection of cryogenic targets into the OMEGA laser chamber, which will be taking place soon, will add knowledge in that important area.

Midterm 20 years

Assuming the availability of a 14.1-MeV neutron source, all the material issues relevant to radiation damage can be answered. Individual experiments on the stopping power of fill gas for X rays and ions can be performed on NIF, but not necessarily repetitively. Furthermore, the possibility for the construction of X-1 will add a powerful tool for performing experiments at much higher energy levels than NIF. More elaborate experiments on graphite or SiC scale models with flowing granular solid particles and with high heat flux and repetitive impulses can be performed. Mass flow and heat transfer effects can be studied as well as chemical interactions between materials, in particular T₂ take-up by the graphite and SiC.

Long Term >20 years

Presumably by this time the availability of a demonstration reactor (DEMO) facility will be in place, which will test all the synergistic effects of the fusion phenomenon on a bare wall reactor.

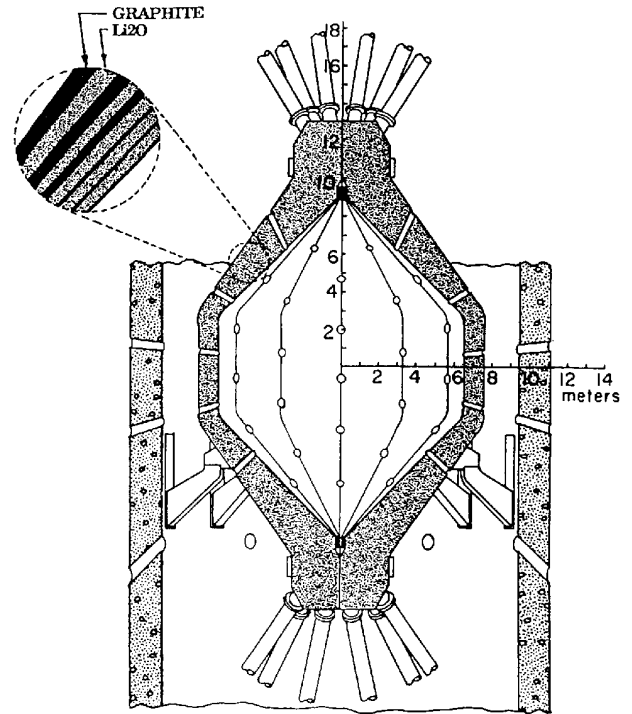

Side view of SOMBRERO chamber.

Proponents' and Critics' Claims

IFE power reactors hold the promise of providing electric power with essentially unlimited fuel supply for generations to come. The combination of a graphite structure for the FW and a flowing granular Li₂O solid breeder as the coolant/breeder provides an attractive option for the dry wall chamber and can play a part by providing safe and environmentally benign solutions at a competitive price relative to other fusion options.

Critics have questioned the T₂ holdup in graphite in such a chamber as well as the disposition of dust generated in it. Also, as usual, critics of fusion will claim that it is too complex, too expensive, and too difficult to maintain. Critics are also concerned about the rapid swelling of carbon fiber composites under neutron irradiation, although, unlike metallic designs where tolerances are tight, these structures are amenable to a high degree of swelling without impacting performance. At 46 dpa and 1600 K, Graphnol N3M returns to the zero swelling level. At a lifetime of 5 FPY, the graphite will accumulate 75 dpa, which means that an assumption is made that materials will be developed that will have a lower rate of swelling.

T-17. IFE TARGET FABRICATION

Description

For direct drive, an inertial fusion target consists of a spherical capsule that contains a smooth layer of deuterium-tritium (D-T) fuel. For indirect drive, the capsule is contained within a metal “hohlraum” that converts the driver energy into X rays to drive the capsule. An inertial fusion power plant must produce, fill with D-T fuel, and deliver to the target chamber about 10^8 targets each year. This must be done with extreme precision of manufacture, extreme reliability of delivery, and for a cost 4 orders of magnitude lower than current inertial confinement fusion (ICF) target fabrication experience. This challenge appears achievable, but will require a serious—and successful—development program.

Status

The fabrication techniques used for ICF research targets meet exacting specifications, have maximum flexibility to accommodate changes in target designs, and provide thorough characterization for each target. Current ICF target fabrication techniques may not be well-suited to economical mass production of inertial fusion energy (IFE) targets. Because of the large number of designs and the thorough characterization required for each target, an ICF target can cost \$2000. For a power plant the target cost must be reduced to about \$0.20. IFE target fabrication studies are encouraging. Fabrication techniques are proposed that are well suited for economic mass production and promise the precision, reliability, and economy needed. However, little work has been done to actually develop these techniques.

- **Fuel capsules.** The capsules must meet stringent specifications including out-of-round ($d_{\max} - d_{\min} < 1 \mu\text{m}$), wall thickness uniformity ($\Delta w < 0.5 \mu\text{m}$), and surface smoothness ($< 200 \text{ \AA}$ RMS). The microencapsulation process appears well-suited to IFE target production if sphericity and uniformity can be improved as the capsule size is increased from current 0.5- to 1-mm capsules to the ~5-mm-diam capsule needed for IFE. Microencapsulation is also well-suited to production of foam shells, which are needed for several IFE target designs.
- **Hohlraums.** ICF hohlraums are made by electroplating the hohlraum material, generally gold, onto a mandrel that is dissolved, leaving the empty hohlraum shell. This technique does not extrapolate to mass production. Stamping, die-casting, and injection molding, however, do hold promise for IFE hohlraum production.
- **Target assembly.** ICF targets are assembled manually using micromanipulators under a microscope. Placement of the capsule at the center of the hohlraum must be accurate to within $25 \mu\text{m}$. For IFE this process must be fully automated, which appears possible. This step is not necessary for direct drive.
- **Target characterization.** Precise target characterization of every research target is needed to prepare the complete “pedigree” demanded by the ICF experimentalists. Characterization is largely done manually and is laborious. For IFE the target production processes must be sufficiently repeatable and accurate that characterization can be fully automated and used only with statistical sampling of key parameters for process control.
- **D-T filling and layering.** Targets for ICF experiments are filled by permeation, and a uniform D-T ice layer is formed by “beta layering.” Using very precise temperature control, excellent layer thickness uniformity and surface smoothness of about $1\text{-}\mu\text{m}$ RMS can be achieved. These processes are suited to IFE although the long fill and layering times needed may result in large (up to ~10 kg) tritium inventories. Advanced techniques could greatly reduce this amount. If IFE targets need D-T ice smoothness better than $\sim 1 \mu\text{m}$ to achieve high gain, new layering techniques will be needed.

Current Research and Development (R&D)

R&D Goals and Challenges

The ICF program is developing targets for the National Ignition Facility (NIF). Target fabrication development for IFE remains to be done. Larger capsules, materials such as foams for high gain targets, techniques for mass production, and statistical characterization must be developed.

R&D Goals and Challenges

- Work closely with IFE target designers to develop IFE targets that optimize achievement of high gain against practical, low-cost fabrication and both mechanical and thermal robustness.
- Develop fabrication techniques for target designs and materials that are needed for IFE, such as foams.
- Investigate scaling of target fabrication techniques to mass production.
- Develop techniques and protocols for filling and layering IFE targets to suitable specifications.
- Include the economic, safety, and environmental aspects of target fabrication in IFE power plant design studies.

Related R&D Activities

The ICF program is developing targets for NIF, including fabrication of 2- to 3-mm-diam capsules, production of cryogenic hohlraums, cryogenic D-T filling and layering protocols, and enhanced smoothness D-T layering techniques. Fabrication of new target materials that are relevant to IFE targets, such as foams, may also be developed.

Recent Successes

The ICF program has accomplished the following IFE-relevant successes:

- Polymer capsules approaching NIF specifications (~2-mm diam) have been fabricated.
- D-T layering has achieved ~1- μm RMS surface smoothness on D-T ice in a spherical polymer capsule.
- The IR layering technique has achieved surface smoothness improvement to approximately 0.7- μm RMS.

Budget

DOE-OFES: FY 1998 = \$0; FY 1999 = \$100K; FY 2000 = \$1400K, and FY 2001 = \$1500K.

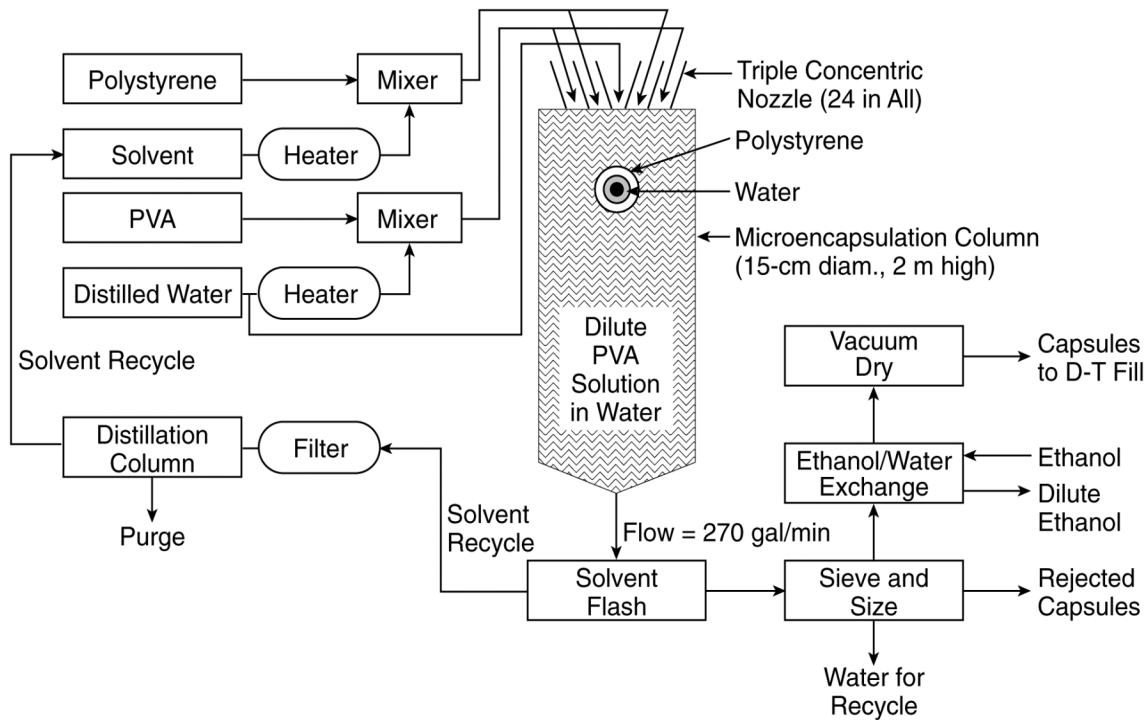

Schematic of possible IFE capsule fabrication process using microencapsulation.

Anticipated Contributions Relative to Metrics

Metrics

- The ability to fabricate an IFE target that meets these specifications.
Indirect drive: 5-mm diam with $<1 \mu\text{m}$ OOR, $\sim 100\text{-}\mu\text{m}$ wall with $<0.5 \mu\text{m}$ Δw , $<200 \text{ \AA}$ RMS surface smoothness, and surface power spectrum below NIF profile.
Direct drive: 5-mm diam with $<1 \mu\text{m}$ OOR, $\sim 10 \mu\text{m}$ wall with $<0.5 \mu\text{m}$ Δw , $<200 \text{ \AA}$ RMS surface smoothness, and surface power spectrum below NIF profile.
- The ability to fabricate new materials and configurations for high-gain IFE targets, such as foams for X-ray heated direct drive targets and high-Z overcoats for shock-heated direct drive targets.
- A projected cost of IFE target fabrication for a power plant at a cost of $< \$0.20$ each.

Near Term ≤ 5 years

- Work with IFE target designers to jointly agree on IFE target designs that promise high gain, practical fabrication, good mechanical strength, and good thermal robustness
- Develop fabrication techniques for IFE target materials and concepts if different than those needed for ICF.
- Investigate, select, and demonstrate target fabrication techniques for low-cost mass production.
- Develop needed characterization and statistical sampling techniques.
- Demonstrate D-T layering protocols suitable for IFE targets.
- Develop a detailed IFE “target factory” conceptual design and cost estimate.

Midterm ~ 20 years

- Test IFE target concepts in the NIF. Determine sensitivity to target fabrication parameters and tolerances.
- Adjust design and production techniques to accommodate results of NIF IFE target experiments.
- Field IFE targets in a repetition-rated IFE facility.
- Adjust IFE target factory estimates to reflect results from target development and testing experiments.

Long Term > 20 years

Provide the technology for construction of the target factory of an IFE power plant.

Proponents’ and Critics’ Claims

Proponents point to the IFE design studies and conclude that the goals of IFE target fabrication can be achieved, but a serious development program will be required. Critics point to the stringent requirements for reliability and accuracy and to the 10^4 reduction needed from current ICF target fabrication costs and conclude that this is a impossible challenge.

T-18. IFE TARGET INJECTION AND TRACKING

Description

For inertial fusion energy (IFE), we must shoot about 10^8 cryogenic targets each year at a rate of up to 10 Hz in a target chamber operating at 500–1500°C, possibly with liquid walls. The only way to do this will be to inject the targets into the target chamber at high speed, track them, and hit them on the fly with the driver beams. This must be done with high precision ($\sim\pm 200\ \mu\text{m}$ at 10 m), high reliability of delivery, and without damaging the mechanically and thermally fragile targets. This challenge appears to be achievable, but it will require a serious and successful development program.

Status

Design studies of target injection were done as part of the SOMBRERO and OSIRIS IFE power plant studies completed in early 1992. The direct-drive SOMBRERO design used a gas gun to accelerate the cryogenic target capsules enclosed in a protective sabot. After separation of the sabot, the capsule was tracked, and the laser beams were steered by movable mirrors to hit the target. The indirect-drive OSIRIS design used a similar gas gun system without a sabot for injection and crossed dipole steering magnets to direct the beams. Analyses of target injection and tracking systems for indirect drive have been carried out at Lawrence Livermore National Laboratory (LLNL) and predicted that IFE targets could survive the mechanical and thermal environment during injection. A gas gun indirect-drive target injection experiment was then constructed and operated at Lawrence Berkeley National Laboratory (LBNL). The results showed that relatively simple gas gun technology could repeatedly inject a simulated indirect-drive target to within about 5 mm of the driver focus point, easily within the range of laser or beam steering mechanisms to hit, but not sufficient to avoid the need for beam steering. Photodiode detector technology was adequate to detect the target position with sufficient accuracy that the driver beams should be able to achieve the approximately $\pm 200\text{-}\mu\text{m}$ accuracy needed.

A significant effort is under way in the inertial confinement fusion (ICF) program to develop cryogenic targets for experiments on Omega and the National Ignition Facility (NIF). This work has advanced the understanding of the thermal and mechanical characteristics of cryogenic targets. Some features of cryogenic target handling are more challenging than had previously been assumed. In a similar vein, the latest designs of high-gain IFE targets may have different mechanical and thermal capabilities than those assumed in earlier studies. These lessons learned must be incorporated into the IFE target injection and tracking concepts.

There are several necessary steps in demonstrating the feasibility of IFE target injection and tracking. Utilizing the gas gun at LBNL that was used to demonstrate the accuracy of injection and tracking for indirect-drive targets, tests are planned to demonstrate sabot removal and injection accuracy for direct-drive targets. Tests are also planned to couple the gas gun with a low current ion beam to demonstrate hitting an indirect-drive target on the fly. The next step is to design and build a prototypical cryogenic target injection system and demonstrate these operations with representative cryogenic targets. Finally, these systems must be made to operate reliably on an ~5- to 10-Hz repetition-rated basis.

Current Research and Development (R&D)

Work is currently being done to continue the target injection and tracking studies and experiments described above.

R&D Goals and Challenges

- Reassess earlier studies with current understanding of the designs, properties, and limits of cryogenic IFE targets.
- Investigate techniques for thermal protection of IFE targets such as sabots and sacrificial frost layers.
- Evaluate target injection and tracking techniques for use with direct drive.
- Extend the gas gun experiments to include key feasibility issues associated with direct-drive targets, such as sabots.
- Carry out proof-of-principle experiments on direct-drive injection techniques such as electrostatic transport.
- Work with IFE driver developers to include beam steering considerations in target injection system design and to demonstrate integrated injection-tracking-pointing system capability.
- Demonstrate target injection and tracking with prototype cryogenic IFE targets.
- Demonstrate reliable, repetition-rated IFE target injection and tracking capability.

Related R&D Activities

- The ICF program at LLNL, Los Alamos National Laboratory (LANL), and General Atomics (GA) is developing the database for cryogenic target fabrication, filling, layering, and handling. We must take full advantage of this information.
- The magnetic fusion plasma fueling program at Oak Ridge National Laboratory (ORNL) is dealing with injection of deuterium-tritium (D-T) ice pellets. We must maximize cooperation with that program.

Recent Successes

Experiments at LBNL have successfully demonstrated that (1) relatively simple gas gun technology can repeatedly inject a non-cryogenic simulated indirect-drive target to within the range of laser or beam steering mechanisms to hit, and (2) simple diode detector technology is adequate to provide the measurement accuracy needed (see Fig. 1).

Budget

DOE–OFES: FY 1998 = \$220K, FY 1999 = \$200K, FY 2000 = \$1500K, and FY 2001 = \$1600K.

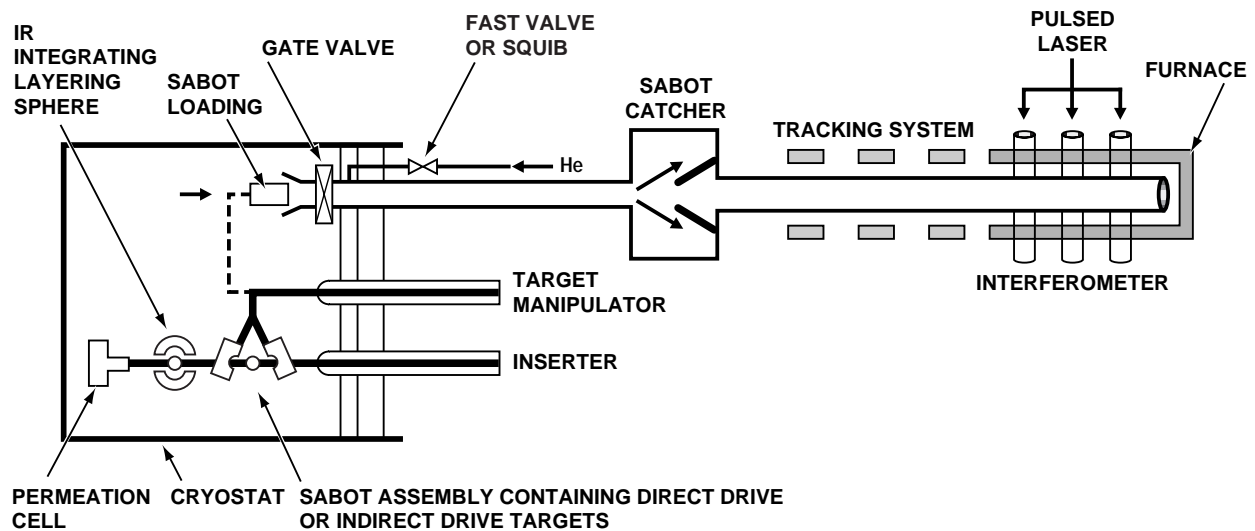

Fig. 1. Simplified schematic of experimental system to address IFE target survivability.

Anticipated Contributions Relative to Metrics

Metrics

- The ability to inject direct- and indirect-drive IFE targets with sufficient accuracy that laser and heavy-ion driver developers can hit them—currently expected to be approximately ± 10 mm.
- The ability to detect targets and for driver developers to hit them with sufficient accuracy as not to degrade target gain—currently expected to be $\sim \pm 200$ μm for indirect drive.
- The ability to inject targets without mechanically damaging them.
- The ability to inject targets into a simulated IFE power plant chamber environment while protecting the thermal integrity of the D-T ice layer.
- The ability to do all of this with high reliability at a repetition rate of ~ 5 Hz.

Near Term = 5 years

- Reassess earlier target injection studies with the latest understanding of the designs, properties, and limitations of cryogenic IFE targets.
- Work with IFE target designers and target fabricators to jointly agree on IFE target designs that promise high gain and practical fabrication with the mechanical strength and thermal robustness needed to survive injection.
- Develop target injection systems that meet the accuracy requirements for IFE.
- Work with driver developers to demonstrate their ability to steer the beams to hit an injected target.
- Develop cryogenic target injection techniques and demonstrate that cryogenic targets can be injected without mechanical or thermal damage.
- Develop a detailed IFE target injection system conceptual design and cost estimate.

Midterm ~20 years

- Develop and demonstrate an integrated cryogenic target injection, tracking, and beam steering system.
- Demonstrate operation of the integrated cryogenic system with high reliability.

Long Term >20 years

- Provide the technology for construction of the target injection and tracking system of an IFE power plant.

Proponents' and Critics' Claims

Proponents point to the IFE design studies and cite the specifications for a variety of high-technology defense systems and conclude that IFE target injection, tracking, and beam steering will require serious development effort, but will be achievable. Critics point to the mechanical and thermal fragility of current IFE target designs and to the incredibly hostile environment of an IFE target chamber and claim that this is a formidable challenge.

T-19. IFE POWER PLANT TECHNOLOGIES

Description

An inertial fusion energy (IFE) power plant consists of four main subsystems: a driver, fusion chamber, power conversion system, and a target factory. Conceptual design studies have been completed over the years to investigate various driver/chamber/target options. Details on the drivers and target physics are discussed in other sections. In this section and in several that follow, the focus is on the nondriver technologies and interface issues. These include dry- and liquid-wall chambers, final optics for lasers, final focus magnets for accelerators, target fabrication, target injection and tracking, and environmental and safety (E&S) aspects. An important feature of IFE power plants is the separability of the driver, target factory and fusion chamber. While the interface between these systems results in important design constraints, a large degree of design flexibility is available. For example, the target performance depends only on the ability to deliver the required beam energy in the correct way (i.e., pulse shape and beam quality) to the target; it does not depend on the geometric configuration of the surrounding chamber. As a result, IFE power plant designs have considered a wide array of combinations of target types, chamber designs, and drivers. At this time, however, the systems that appear to show the most promise are characterized by two broad classes: (1) dry-wall chambers with direct-drive targets and laser drivers, and (2) liquid-wall chambers with indirect-drive targets and heavy ion drivers.

Status

Work on nondriver technologies has been very limited, consisting primarily of conceptual design studies, computer simulation and modeling, and small-scale laboratory experiments primarily at universities. One exception is the target fabrication work in support of the Department of Energy (DOE)–Defense Programs (DP).

- Many integrated conceptual design studies have been completed for IFE power plants. The most recent work includes Sombrero, Prometheus-L, and KOYO for lasers; HYLIFE-II, Prometheus-H, and Osiris for heavy ions; LIBRA for light ions; and an international effort to produce the International Atomic Energy Agency (IAEA) book, *Energy from Inertial Fusion*.
- Computer simulation of the response of in-chamber conditions to the pulsed energy release have been carried out at several universities. These simulation tools continue to grow in sophistication and are benchmarked to experiments whenever possible.
- Experiments on various aspects of liquid-wall chambers have also been conducted at the university level, and work is planned to continue and expand these efforts.
- Conceptual designs and preliminary analyses for final optic systems have been completed. Experiments are being planned to address critical issues with various approaches. Some radiation damage data have been obtained for fused silica.
- A target injection experiment was conducted at Lawrence Berkeley National Laboratory (LBNL) using a room temperature surrogate indirect-drive target. Plans are under way to extend this work to cryogenic temperatures with real direct- and indirect-drive targets.
- Techniques for low-cost, mass production of IFE targets have been identified, and costs estimates indicate that cost and production rate goals (<\$0.25/target, at 4–10 Hz) are achievable, but these techniques require research, development, and demonstration (RD&D).
- E&S studies of IFE power plants have been part of all major conceptual design studies, and comparative studies have also been conducted. With some design modifications and more sophisticated analysis (e.g., including realistic isotope release data), the E&S goals are expected to be met.
- Economic systems studies show that IFE in general might be competitive with other fusion approaches (\$0.06 to \$0.08/kWh) and that the thick-liquid-wall approach can be competitive with advanced fission (\$0.04 to \$0.05/kWh) and coal (\$0.05 to \$0.06/kWh), if the projected target performance and driver costs are achieved.

Current Research and Development (R&D)

R&D Goals and Challenges

- Verify the ability of chamber concepts to (1) survive the fusion energy pulse for adequate time periods and (2) recover sufficiently between shots to allow target injection and beam propagation for the next shot.
- Verify the operation and survivability of final optics concepts.
- Verify target injection performance and survivability of cryogenic targets and demonstrate low-cost, mass production of targets.
- Quantify and improve E&S and economic aspects of power plant designs.

Related R&D Activities

- DP work on target fabrication and final optics protection for inertial confinement fusion (ICF) laser systems will include some aspects that are applicable to IFE; the National Ignition Facility (NIF), Z, and/or X-1 will provide high energies for coupled ablation/venting/condensation experiments; advanced target modeling will quantify target X-ray and debris emissions.

Recent Successes

- A variety of conceptual design studies show that IFE can meet economic and E&S goals for future energy systems.

Budget

FY 1999 = \$1–2M.

Anticipated Contributions Relative to Metrics

Metrics

The primary metrics for commercial power plants are competitive cost of electricity (COE) and attractive E&S characteristics that can compete with future energy sources. Achieving a competitive COE depends on combined success in achieving low capital cost, good target performance (high gain, G), good driver performance (high efficiency, η), and high reliability of all the major subsystems (target factory, driver, chamber, and power conversion equipment). The fraction of the gross electric power production needed to run the driver is called the recirculating power fraction and is inversely proportional to the product ηG . The optimal ηG depends on the achievable target gain and driver cost as a function of driver energy. If capital costs are low enough, competitive COE can be obtained even with relatively low ηG (<10). The sensitivity of the COE to changes in η or G decreases with increasing ηG . Integrated systems models for power plants, which include these cost and performance scaling relationships, are used to determine optimum operating points.

Achieving acceptable E&S characteristics (e.g., requirement for no public evacuation plans) depends on either the development of low-activation structural materials with acceptably long radiation damage lifetime or demonstration of the ability to shield ordinary steels with a thick liquid wall that is self-renewing. Attractive E&S characteristics will also require design for tritium containment during recovery and recycle into new targets and minimization of the plant tritium inventory, which may require rapid tritium-fill techniques.

Near Term <5 years

- Chambers—Continue development of computer modeling capabilities and conduct experiments on an aspect of chamber performance such as beam propagation through gas and liquid flow experiments.
- Optics—Analyze and test various concepts to demonstrate basic feasibility questions.
- Target fabrication—Develop foam targets for direct drive and include IFE considerations in DP target fabrication efforts.
- Target injection—Conduct proof-of-concept experiment with cryogenic direct- and indirect-drive targets.
- E&S and economics—Continue to develop and utilize E&S and systems modeling tools.

Midterm ~20 years

- Develop adequate life chamber structures and final optics materials where needed.
- Develop, demonstrate, and integrate low-cost target fabrication technologies.
- Demonstrate final optics with full-scale beam line.
- Ensure progression of increasingly integrated chamber experiments and model refinement, leading to design and demonstration of a chamber for average power production in an engineering test facility (ETF).

Long Term >20 years

- Construct a demonstration power plant.

Proponents' and Critics' Claims

Proponents claim that IFE power plants can provide an attractive future energy source that can compete with the alternatives on economic and E&S criteria. They claim that the separability of IFE subsystems allows pursuit of parallel paths to minimize risk and testing of components at small scale, which will reduce development costs. The ability to use liquid walls is a great advantage because the need for a material development program can be avoided, chamber availability increases, and cost of blanket change-out decreases, leading to lower COE. Proponents also point out that it is important to take advantage of the investment being made by DOE–DP on ICF to utilize this technology for energy as well.

Critics claim that IFE power plants depend on technologies that have serious feasibility/credibility issues that are unlikely to be favorably resolved, such as low-cost drivers and low-cost target production, the ability to track a target and hit it with the driver beam while it is traveling 100–200 m/s, the ability of the chamber to reestablish conditions needed for target injection and beam propagation in 200 ms or less, and the survivability of first-wall structure (dry wall) or the feasibility of liquid-wall chamber operating as advertised at 4–10 Hz. Critics also question the attractive COE projections and the reliability of an integrated plant with tens of thousands of optics or magnetic components.

Description

Advanced design activities help shape the directions of the fusion energy sciences program by examining the technical and economic potential of specific concepts such as electric and nonelectric energy sources. This is accomplished by analyzing potential pathways to fusion development; incorporating plasma physics and technology research and development (R&D) into design methods; conducting systems analysis of technical, economic, safety, and environmental performance; and by defining R&D needs to guide present and future experimental and theoretical studies.

Status

- **Power plant studies.** Power plant studies have been performed for three decades. Since 1986, magnetic fusion energy (MFE) power plant studies have been coordinated through the nationally organized Advanced Reactor Innovation and Evaluation Studies (ARIES) team. During the past 12 years, numerous studies have been undertaken in support of changing strategies and focus of the domestic fusion program. Full power plant studies have been performed for a reversed-field-pinch (TITAN), a stellarator (SPPS), and several tokamaks (ARIES-I through IV, PULSAR, and ARIES-RS). The current study of a spherical tokamak (ARIES-ST) is nearing completion. Concurrent with examination of these confinement concepts, many innovative technology solutions have been proposed or examined. Power core design concepts featuring advanced ferritic steels, vanadium alloys, and SiC/SiC composites have been technically assessed in system studies. Advanced divertor concepts have been examined. A variety of enabling technology innovations have been developed in the areas of magnet systems, heating and current drive, fueling, and maintenance schemes.
- **Next-step option (NSO) studies.** Design of fusion test facilities such as burning plasma experiments and technology and material testing facilities are under way to provide data to enable program decisions. This program element includes ongoing analysis of critical issues, maintenance of necessary physics and technology databases and identification of their limitations, development of engineering and physics design analysis capability, and assessment of systems issues arising from physics-technology interfaces. This program element also links broad national and international interests in fusion development and explores options with substantial variation in performance, cost, and technology requirements.
- **Markets, customers, and strategic planning.** The advanced design studies program has engaged in scoping studies to provide a clearer vision of the performance, economic, safety, and environmental requirements for a viable fusion energy source. The ARIES team established a Utility Advisory Committee, which worked in conjunction with a similar Electric Power Research Institute (EPRI) fusion working group, to help develop economic requirements and a new Department of Energy (DOE) fusion safety standard. Efforts to quantify markets and customers for current and evolving fusion applications are ongoing. A new initiative to explore potential neutron source design concepts has been started.

Current Research and Development**R&D Goals and Challenges**

The goal of conceptual power plant studies is to articulate a vision for commercially viable fusion products by determining the specific technical requirements and integrating recent R&D results into the most attractive and technically credible product. High-leverage areas of R&D are determined such that new directions for the base program can be initiated to improve the attractiveness of the products. High capital cost combined with present uncertainties in physics and engineering capabilities, as well as the uncertainties in the future marketplace, are principal challenges in meeting the overall goal.

The primary goal of NSO studies is to develop cost reduction strategies for burning plasma experiments by establishing technical objectives and margins, with a view to establishing minimum cost option(s) that satisfy the overall programmatic objectives; and by assessing the rationale of broader concepts to achieve the proposed performance guidelines and the positive or negative impact on the development path toward fusion energy.

Related R&D Activities

The success depends strongly on interactions with the major physics and technology R&D elements of the U.S. and world fusion programs. Similar activities exist in Japan and Europe, although the U.S. program has more ambitious goals.

Recent Successes

ARIES-I set a benchmark for the tokamak program for several years and was used as one guide for the design and research program for the Tokamak Physics Experiment (TPX). The advancement of SiC/SiC composites for their safety and environmental features led to a significant materials R&D program. The ARIES-RS design, which grew out of the most favorable operating mode discovered for the TPX, is now recognized by the worldwide fusion community as a reference advanced tokamak (AT) for both the physics and technology programs. ARIES-RS, and especially ARIES-ST, have demonstrated design methods for rapid maintenance, which allow for high plant availability. Physics “figures of merit” have been quantified to help guide the physics and confinement programs, and low-cost fabrication techniques have been proposed. Other recent accomplishments include the many aspects of the ITER engineering design and the development of physics and engineering design solutions.

Budget

The budget for ARIES power plant studies is approximately \$1.9M and is distributed to Argonne National Laboratory (ANL), General Atomics (GA), the Massachusetts Institute of Technology (MIT), Pacific Northwest National Laboratory (PNNL), Princeton Plasma Physics Laboratory (PPPL), the University of California–San Diego (UCSD), Boeing, and the University of Wisconsin–Madison. Idaho National Engineering and Environmental Laboratory (INEEL) provides additional support from safety and environmental program funds. The NSO budget is approximately \$3.5M.

Anticipated Contributions Relative to Metrics

Metrics

Quantitative metrics for evaluating the attractiveness of fusion power plants have been developed and continue to evolve as a result of interactions with customers, interest groups (such as environment advocates), government, and industry representatives. These metrics relate to economics, safety, and environment, special attributes such as operability and plant size, and physics figures-of-merit. Unlike R&D programs in which achievement of the metrics is demonstrated via experiments and fundamental research, integrated conceptual design studies rely on close coupling to the base program. The contribution of power plant studies is achieved through assessments and recommendations that help guide the DOE program to the desired goal. The pace of progress is intimately tied to the pace of progress in the base program.

Near Term ≤ 5 years

Deliverables for power plant studies include the following:

- Advanced power plant studies of tokamaks and alternatives [including inertial fusion energy (IFE)] as new information becomes available and/or a concept enters the proof-of-principle stage.
- Conceptual design studies of advanced neutron sources for nonelectric applications and for fusion development (technology testing).
- Design studies of a large-output fusion device for hydrogen (or cogeneration).

The primary deliverable for the NSO program is to develop a low-cost design option.

Proponents' and Critics' Claims

During the past decade, one of the recurrent criticisms of fusion energy is that the product is not sufficiently attractive; even if we succeed in developing a fusion power plant, no one will want it. The high cost of a next-step device exacerbates this criticism and makes people wonder how an experiment can cost more than the final product. Recent criticism suggests that the problems with fusion are too difficult to solve. In defense of the program, dramatic improvements in our vision of an attractive power plant have emerged during the past decade through innovations and positive R&D results. As compared with tokamaks of the 1970s and 1980s, the current generation of ATs offers many features that would lead to an attractive base-load generating station. Utility representatives have indicated that the projected cost of electricity from fusion is not unreasonable if the technology can be developed as currently envisioned. As one of very few options for a long-term and environmentally acceptable energy source, the United States and the world cannot afford to ignore the potential of fusion.

C.5 PLASMA SCIENCE

A plasma is a gas or fluid in which the two charged atomic constituents—positive nuclei and negative electrons—are not bound together but able to move independently: the atoms have been ionized. (The term “plasma” was first used by Langmuir in 1928 to describe the ionized state found in an arc discharge.) Because of the strength and long range of the Coulomb interaction between such particles, plasmas exhibit motions of extraordinary force and complexity. Even in the most common “quasi-neutral” case where the net charge density nearly vanishes, small, local charge imbalances and local electric currents lead to collective motions of the fluid, including a huge variety of electromagnetic waves, turbulent motions, and nonlinear coherent processes.

Plasma is the stuff of stars as well as interstellar space; it is the cosmic medium. Plasma also provides the earth's local environment, in the form of the solar wind and the magnetosphere. It is in some sense the natural, untamed state of matter: only in such exceptional environments as the surface of a cool planet can other forms of matter dominate. Moreover terrestrial plasmas are not hard to find. They occur in, among other places, lightning, fluorescent lights, a variety of laboratory experiments, and a growing array of industrial processes. Thus the glow discharge has become a mainstay of the electronic chip industry. The campaign for fusion power has produced a large number of devices that create, heat, and confine plasma—while bringing enormous gains in plasma understanding. The high electrical conductivity in quasineutral plasmas short-circuits electric fields over length scales larger than the so-called Debye length, $\lambda_D = 69 [T(^{\circ}\text{K})/n (\text{m}^{-3})]^{1/2}$ m, where T is the temperature and n the density. (A similar effect, involving plasma rotation, occurs in magnetized nonneutral plasmas.) The collective effects most characteristic of plasma behavior are seen only on longer length scales, $L \gg \lambda_D$. An important categorization of plasma processes involves the so-called plasma parameter, $\Lambda = 4 \pi n \lambda_D^3$, measuring the number of particles in a “Debye sphere.” Note that Λ decreases with increasing density. Most terrestrial and space plasmas have $\Lambda \gg 1$, while the extremely dense plasmas occurring in certain stellar and inertial fusion environments can have $\Lambda < 1$. The latter are called *strongly coupled* plasmas.

Conceptual tools

The central intellectual challenge posed by plasma physics is to find a tractable description of a many-body system, involving long-range interactions, collective processes, and strong departures from equilibrium. This challenge has stimulated a remarkable series of scientific advances, including the concept of collisionless (Landau) damping, the discovery of solitons, and the enrichment of research in chaos. It is deep enough and difficult enough to remain a challenge of the highest level for many years—even with the huge increases in computational power that it has helped to stimulate. It has been addressed so far by a combination of several approaches. The simplest route to insight is to track the motion of individual charge particles in external prescribed magnetic and electric fields. In a nonuniform magnetic field, the orbit of a charged particle consists not only of the basic helical motion around a field line but also of the guiding-center drifts arising from gradients and curvature of the magnetic fields. Kinetic theory, using an appropriate version of the Boltzmann collision operator, provides a more generally reliable, if not always tractable, approach. In the case of a stable (nonturbulent) plasma, the kinetic approach reduces to a plasma version of collisional transport theory and provides useful expressions for the particle and heat fluxes. If the plasma is magnetized, transport processes perpendicular to the magnetic field are accessible even when the collisional mean-free path is very long—even, that is, when guiding-center drift motion between collisions must be taken into account. Such transport is termed *classical* or, when it is affected by guiding-center motion, *neoclassical*. Fluid descriptions of plasma dynamics make sense in certain circumstances; they are almost always used to describe turbulence. Sufficiently fast motions of a magnetized plasma are accurately characterized by a relatively simple fluid theory, called magnetohydrodynamics (MHDs). MHDs and its variants remain the major tools for studying plasma instability. Instabilities lead generally to turbulence and to the increase of transport far above classical or neoclassical levels. Other, slower instabilities require a more complicated description, essentially because their timescales are comparable to those of the guiding-center drifts, collisions, or other processes omitted by MHD. Drift waves, which can be destabilized by fluid gradients, are a characteristic example; a drift-wave instability driven by temperature gradients is believed to dominate transport in many tokamak experiments. Such phenomena are studied using kinetic theory or by means of a variety of fluid models, all approximate.

Description

Discrete Hamiltonian dynamics is defined by the ordinary differential equations $dq/dt = \partial H(p, q, t)/\partial p$ and $dp/dt = -\partial H/\partial q$. The variables (p, q, t) are the canonical momentum, coordinate, and time, and H is the Hamiltonian. Continuum Hamiltonian dynamics is an analogous set of equations but with p and q generalized from being variables to functions of position, momentum, and time. Discrete Hamiltonian dynamics has three areas of application: the trajectories of charged particles, the rays of geometric optics, and the trajectories of magnetic field lines. Continuum Hamiltonian dynamics gives systematic methods of calculation in the fluid (magneto-hydrodynamic) theory of plasmas and in the kinetic (Vlasov or gyrokinetic) theory.

Status

The magnetic fusion program has been the origin of many of the widely recognized developments of Hamiltonian dynamics. Examples include the techniques pioneered by J. Greene for finding the threshold of chaotic dynamics, techniques for removing chaos, and noncanonical Hamiltonian dynamics.

Current Research and Development (R&D)

R&D Goals and Challenges

The classical application of Hamiltonian dynamics has been to the study of particle trajectories. A plasma example is the simplification of trajectory calculations, using the conservation of the magnetic moment to define a drift Hamiltonian. The drift Hamiltonian eliminates the need for following the circular gyromotion of charged particles and provides an enormous saving of computer resources. However, the saving of a few orders of magnitude in computer time is trivial when compared to other benefits:

- The discovery of the chaotic loss mechanism for fusion alphas, which determines the number of toroidal field coils required in a tokamak power plant. This discovery was made using the techniques of maps of Hamiltonian dynamics applied to the drift Hamiltonian.
- Solutions to what was thought to be a fatal flaw of stellarators—poorly confined particle drift orbits. The drift Hamiltonian implies the magnitude of the magnetic field, and not the vector properties; it determines the quality of trajectory confinement transverse to the magnetic field. The field strength, and therefore the drift Hamiltonian, can have a symmetry, such as toroidal symmetry, not possessed by the magnetic configuration. Such symmetries ensure the invariance of a component of the canonical momentum and excellent trajectory confinement. This is the concept of a quasisymmetric stellarator. Stellarators with good trajectory confinement are also based on the concept of quasi omnigeneity, another invention that came from exploiting the dependence of the drift Hamiltonian on the magnitude, and not the vector properties, of the magnetic field.
- Efficient numerical simulations of plasma transport properties based on the drift Hamiltonian. These simulations use either Monte Carlo methods to obtain the transport associated with given electric and magnetic fields or determine self-consistently the fluctuating electric potentials and their effects on the charged particles that form a plasma. Techniques developed for toroidal plasmas are used in the study of astrophysical plasmas.
- The preservation of the subtle constraints on trajectories in Hamiltonian dynamics. Appreciation of these constraints has led to symplectic integration algorithms, which preserve the exact Hamiltonian structure and greatly improve the reliability of calculations of long-term trajectory behavior.

Related R&D Activities

The propagation of waves that have a short wavelength in comparison to the scale in which they are propagating is given by Hamiltonian dynamics with the wave frequency being the Hamiltonian and the wave vector the canonical momentum. These equations are the basis for the many ray propagation codes used throughout plasma physics.

Recent Successes

The fact that the magnetic field lines in toroidal plasma confinement devices rigorously obey Hamiltonian dynamics may be surprising. The three spatial coordinates (x, y, z) of field lines are functions of the three canonical variables (p, q, t) of a Hamiltonian. With the realization that field lines obey exact Hamiltonian dynamics, several important advances in plasma physics were quickly made.

- Chaotic field line effects were incorporated into the particle drift equations and, therefore, into Monte Carlo simulations of transport.
 - Methods for eliminating the deleterious effects of magnetic field perturbations using trim coils were developed. Originally the focus of this technique was stellarators, but it has recently been appreciated that large tokamaks may require trim coils. Techniques that were developed to improve magnetic surfaces have been extended to improve the quality of particle confinement in accelerators.
 - The role of the parallel electric field in the break up of magnetic surfaces was clarified.
 - The importance of nulls in the evolution of astrophysical magnetic fields was appreciated and is being investigated using Hamiltonian techniques.
-

Anticipated Contributions Relative to Metrics

Metrics

The measures by which progress in Hamiltonian dynamics can be judged are (1) the insights afforded that lead to significant inventions, (2) the improved understanding of plasma phenomena, and (3) the development of new or more efficient calculational techniques. Areas in which rapid progress is being made in the application of Hamiltonian dynamics include (1) methods for simplifying the design of stellarator coils while preserving the quality of the magnetic surfaces, (2) the properties of the divertor separatrix in a tokamak in the presence of magnetic perturbations, and (3) the nature of negative energy modes (perturbations that reduce the system energy) in plasmas and their relation to similar modes in fluids.

Proponents' and Critics' Claims

In many fields of plasma physics, such as in stellarator research, the applications of Hamiltonian dynamics have become so pervasive that they define the way of thinking and are no longer considered the preserve of theorists or a special set of techniques. In these areas, asking the future importance of Hamiltonian techniques is almost like asking the future importance of the techniques of calculus.

S-2. LONG MEAN-FREE PATH PHYSICS

Description

In a plasma (or neutral gas) dominated by collisions, particle motion is randomized on a spatial scale that is short compared to the scale for change in the temperature or density. As a result, the plasma flows of mass and heat are linearly related to the local pressure and temperature gradients, and a tractable fluid description—exemplified by the equations of Spitzer, Chapman-Cowling, or Braginskii—is possible. Fluid equations have the key advantage of being set in three-dimensional coordinate space rather than the six-dimensional phase space of the kinetic equation. For small collisionality, on the other hand, closure of fluid equations is not obviously possible, and the traditional approach has been to revert to kinetic theory. The primary goal of long mean-free path research is to find a contracted description of a collisionless or nearly collisionless plasma that attains some of the simplicity of the fluid description. In particular, while application of long mean-free path research invariably uses computation, one seeks to improve on the computational enormity of raw particle simulation and its variants.

Because the spatial localization provided by cyclotron (or guiding-center) orbits in a magnetized plasma allows a straightforward fluid description of dynamics perpendicular to the field, most long mean-free path theory is focussed on parallel dynamics. It is often studied in combination with plasma-neutral interactions, as well as atomic physics.

Status

Long mean-free path research has been dominated by theory because of its intrinsic theoretical interest, especially as a domain from which fundamentally new plasma descriptions might arise and because direct experimental tests of long mean-free path constructs are rarely straightforward. Yet long mean-free path physics has enormous practical significance, affecting many phenomena—such as plasma stability, laser-plasma interaction, and plasma edge physics—in which gradients can become steep. Partly for this reason, recent experiments on both tokamaks and laser-produced plasmas seem to be slowly changing this theoretical domination; in any case, the recently increased experimental interest is clear.

Current Research and Development (R&D)

R&D Goals and Challenges

The use of long mean-free path physics in fusion science is mainly concerned with three overriding goals:

- Understanding the dynamics of the edge region of a confined plasma. This region determines heat loads on the vessel wall as well as divertor operation; it typically contains subregions in which the gradient scale lengths are no longer than the mean-free path.
- Characterizing heat transport due to high-energy electrons in laser-irradiated plasmas used in inertial confinement fusion. The energy dependence of the Coulomb cross section implies that the mean-free path of energetic electrons approaches the gradient scale length of the ambient plasma.
- Efficiently describing stability, low-collisionality relaxation, and turbulence in the interior region of a magnetically confined plasma, where mean-free paths usually far exceed parallel connection lengths.

Long mean-free path physics involves fundamental questions of particle motion and fluid closure that bear significantly on research in other areas, including astrophysics, short-pulse laser physics, and space physics. (The mean-free path in key regions of the earth's magnetosphere is approximately the same as the distance from the earth to the planet Jupiter.)

Related R&D Activities

The campaign to understand turbulent transport in tokamaks is primarily concerned with perpendicular dynamics but, as noted, uses long mean-free path parallel physics to characterize instability and relaxation mechanisms that underlie the turbulence. The interaction between a hot plasma and electromagnetic radiation (as occurs in various wave-heating schemes) uses long mean-free path physics, even when collisions play a crucial role. Studies of magnetic island formation and evolution, including the “neoclassical instability theory,” invariably use long mean-free path physics.

Recent Successes

The gyro-fluid code, based on a fluid description of long mean-free path parallel dynamics in the tokamak core, made predictions in good agreement with experimental observations over a remarkably wide range of operating conditions on the Tokamak Fusion Test Reactor (TFTR). A combination of fluid and Monte Carlo codes show increasing reliability in predicting edge dynamics on the Doublet III-D (DIII-D) tokamak. Long mean-free path analysis of magnetic island evolution similarly grows increasingly realistic and predictive.

Anticipated Contributions Relative to Metrics

Metrics

Tractable, efficient, numerical–analytical models that use contracted descriptions to accurately describe such areas as pellet dynamics, tokamak divertor operation, and turbulent transport.

Proponents' and Critics' Claims

Because its relation to experiment has been exploited only recently and because of the complexity of the phenomena it attempts to understand, long mean-free path predictions are often disputed. Proponents find experimental encouragement that a contracted yet reliable description of collisionless phenomena is possible and even in part achieved; critics suspect that nothing less than numerical simulation at the particle level can address the relevant issues.

S-3. WAVE-PARTICLE INTERACTIONS

Description and Status

The dynamical evolution of a plasma is often governed by a variety of collective phenomena involving exchange of energy and/or momenta between the plasma constituents and externally (or internally) generated waves (referred to as wave-particle or wave-plasma interactions). Early studies of radio wave propagation in the ionosphere spurred the development of the theory of waves in plasmas. Even today, complicated models involving mode conversion, power absorption, and generation of energetic particles are used in magnetospheric physics and astrophysics to describe such phenomena as solar coronal heating, interactions of the solar wind with the magnetosphere, and cyclotron emission observed in the Jovian system. The use of applied electromagnetic waves for controllable modification of magnetically confined plasmas has been a major part of the fusion program almost since its inception. External means of plasma heating and noninductive current generation have evolved into tools for increased plasma performance through control and modification of plasma density, temperature, rotation, current, and pressure profiles. The localized nature of wave-particle interactions provides a pathway for the development of optimization and control techniques for the creation and long-time-scale maintenance of high-confinement, stable operating regimes in toroidal magnetic confinement systems. Underlying the success of any of these methods are such issues as power deposition localization and power partitioning among plasma species, process efficiency, parasitic absorption paths, plasma profile modifications, and edge interactions. The fundamental models describing these wave-particle interactions are common to all plasmas, both laboratory-based and those that occur naturally throughout the universe.

Current Research and Development (R&D)

R&D Goals, Challenges, and Related Activities

- Continue to develop a fundamental understanding of wave-driven flows in magnetized laboratory and space plasmas.
- Continue to develop a comprehensive understanding of the nature of interactions between plasma waves and energetic particles present in a plasma due to external injection processes, wave-driven acceleration, or as a by-product of fusion reactions.
- Continue to develop the theory of wave-particle interactions in inhomogeneous magnetized plasmas, including plasmas in which the particle's Larmor radius is comparable to the scale length of the waves and/or the size scales of the equilibrium inhomogeneities.
- Experimentally demonstrate and theoretically justify robust methods for transport barrier formation and transport control via localized wave-plasma interactions in a variety of magnetic confinement devices.
- Demonstrate controlled off-axis localized current drive schemes needed for sustaining optimal regimes of operation and/or for feedback stabilization of instabilities in a variety of magnetic confinement devices.
- Complete the development of reliable methods for heating reactor-class plasmas in a variety of magnetic confinement devices.
- Investigate use of radio frequency (rf) for improving tokamak performance via such techniques as alpha channeling, alpha buckets, and bulk plasma rotation drive for suppression of instabilities.
- Continue development of quantitatively accurate theoretical and numerical models capable of providing meaningful extrapolations to next-step devices.
- Concurrently develop advanced wave launchers that can reliably deliver power efficiently to magnetically confined plasmas.

Recent Successes

- Efficient ion cyclotron range of frequencies (ICRF) heating of deuterium-tritium (D-T) plasmas has been demonstrated in reactor-relevant plasmas.
- Slab model wave codes have been developed, which are valid for arbitrary ratios of the ion gyroradius to the perpendicular wavelength.
- Mode conversion has been investigated and benchmarked with theory in laboratory and space-based plasmas.
- The rf-driven energetic ion distributions have been observed to influence the stability of magnetically confined plasmas, in agreement with basic theoretical models.
- Full noninductive current drive in toroidal magnetically confined plasmas has been achieved at moderate densities for pulse lengths lasting up to about 2 min, and at low densities for up to 30 min.
- The rf-driven internal transport barrier formation and enhanced energy confinement have been observed.
- High-confinement regimes with internal transport barriers have been maintained using noninductive current profile control for a few energy confinement times.
- Incomplete suppression of neoclassical instabilities via localized noninductive current drive has been experimentally observed.

Budget

DOE support supplied as part of the funding for major facilities. Some funding from the National Aeronautics and Space Administration (NASA) and the National Science Foundation (NSF).

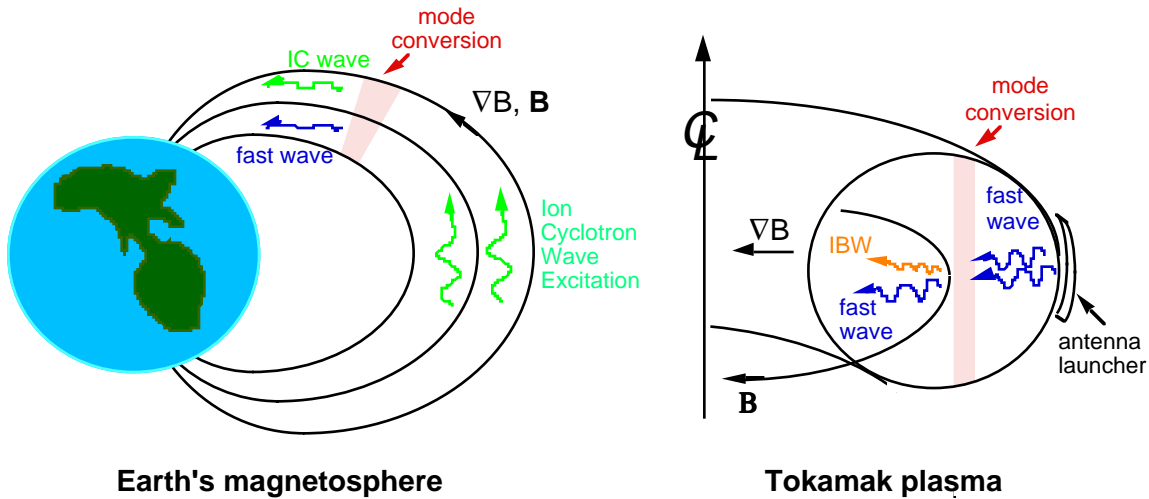

Earth's magnetosphere **Tokamak plasma**
 Electromagnetic wave propagation and mode conversion is common to space and laboratory plasmas.

Anticipated Contributions Relative to Metrics

Metrics

- Quantitatively accurate predictive and analysis code capability.
- Demonstration of robust, reactor-relevant, wave-based profile control techniques with economically acceptable power level requirements.

Near Term ≤5 years

- Experimental evaluation of the effectiveness of rf-based methods for suppression of magnetohydrodynamic (MHD) and neo-classical instabilities.
- Improved numerical codes capable of accurately representing mode conversion phenomena in two dimensions (2-D).
- Experimental evaluation of the effectiveness of rf for the generation of internal transport barriers in magnetically confined plasmas.
- Experimental evaluation of the effectiveness of noninductive current profile control techniques for sustaining high-performance plasmas.

Midterm ~5–10 years

- Detailed understanding of wave propagation, absorption, and mode conversion in magnetically confined plasmas with three-dimensional (3-D) equilibrium inhomogeneities.
- Detailed fully self-consistent 3-D models for wave-plasma coupling dynamics and antenna design optimization.
- Fully self-consistent numerical models that incorporate effects of wave-induced evolution of the particle distribution function on the wave propagation and absorption processes.

Long Term >10 years

- New generation of wave launchers suitable for long-pulse sustained coupling of waves to a high fusion reactivity, reactor-relevant plasma.
- Experimental evaluation of the effectiveness of external wave-based plasma profile control in plasmas with dominant self-heating and self-current generation.
- Fully predictive, fast numerical models for wave coupling, propagation, mode conversion and absorption, with self-consistent treatment of finite orbit effects, wave-induced velocity space evolution of particle distribution functions, energy and momentum diffusion, particle losses and collisions.

Proponents' and Critics' Claims

Based on the achievements of the past two decades, proponents claim that wave-based methods of profile control will provide the improvements needed to make fusion energy production economically attractive. Critics claim that the power levels needed for profile control in a D-T burning plasma will be prohibitively high, that the localization needed for effective profile control will be unattainable, and that real time control of the plasma profiles will prove to be impractical.

S-4. TURBULENCE

Description

Turbulence is a ubiquitous phenomenon in nature. It is generated as a spontaneous way of releasing the free energy associated with gradients. It breaks the symmetry of the physical system and involves multiple time and space scales. In plasmas, turbulence is induced by plasma instabilities that may cover many scale lengths; therefore, there is not necessarily an inertial ranges in those cases (turbulence drive can be active in all ranges of scale lengths).

Turbulence plays several roles in plasma physics phenomena:

- Particle and energy loss in magnetically confined plasmas. Turbulence is the underlying mechanism of standard plasma transport; it can also lead to catastrophic losses, as in the case of disruption phenomena.
- Induced plasma heating by energy transfer.
- Magnetohydrodynamic turbulence in space and astrophysical plasmas.
- Plasma self-organization. Under special conditions, turbulence can transfer energy/momentum from small scales to large scales and can lead to a new state with restored symmetry. Examples are the dynamo effect, shear flow amplification, and zonal flows.

Status

Turbulence is an open issue in science in general. In plasma physics, the research status follows:

- Theory. A limited number of single-equation problems have been treated using renormalization techniques. There is understanding of some turbulence saturation mechanisms: mixing length, resonance broadening, and nonlinear mode coupling. The turbulence suppression by global shear flows has been predicted. There is some initial theoretical understanding of the basic mechanisms leading to self-organization of magnetic fields and global flows. There are possible bifurcations and transitions associated with the plasma self-organization.
- Experiment. Broad fluctuation spectra, both in frequency and wavelength space, have been measured under different conditions. Radial correlation lengths of the order of 1 to 3 cm have been determined in magnetically confined plasmas. There is evidence of turbulence being the cause of anomalous transport in magnetically confined plasmas. There are reasonable (mostly intrusive) diagnostics to investigate turbulence in cold plasmas. In hot plasmas, the diagnostics are limited to the measurement of density fluctuations and electron temperature fluctuations. We lack systematic studies of turbulence properties. Clear experimental evidence of shear flow in suppressing turbulence has been found, although details of the process in different channels need to be unraveled. Experimenters have produced regions where turbulence is suppressed; as a consequence, transport barriers are created in plasmas. Experimenters are able to reproduce the conditions for creation of transport barriers. This leads to improved confinement regimes.
- Modeling. The three-dimensional (3-D) magnetic geometry of confinement systems, the coupling to electromagnetic fields, and the disparity of basic scale length of electron and ion dynamics makes numerical simulation difficult. There has been progress in gyrokinetics and gyrofluid modeling of electrostatic turbulence for limited plasma regions. Resolution is still an issue with present computers. Simulations in realistic geometry are needed (e.g., incorporating X-points); local magnetic shear associated with the divertor X-points (even when the X-points remain outside the vacuum vessel) has a significant impact on the stability of modes leading to boundary turbulence. Comparisons with experiments to date were limited to the ion thermal diffusivity. More comprehensive diagnostics including fluctuation spectra and flux probability distribution function of simulations are needed for detailed and meaningful comparisons to experiments.

Current Research and Development (R&D)

R&D Goals and Challenges

- Control of turbulence in magnetic confinement devices to operate under optimized conditions.
- Understanding magnetic field generation through dynamo effects.

Related R&D Activities

- Confinement and transport studies.
- Plasma instabilities.

Recent Successes

- Understanding the effect of sheared flows on turbulence.
-

Anticipated Contributions Relative to Metrics

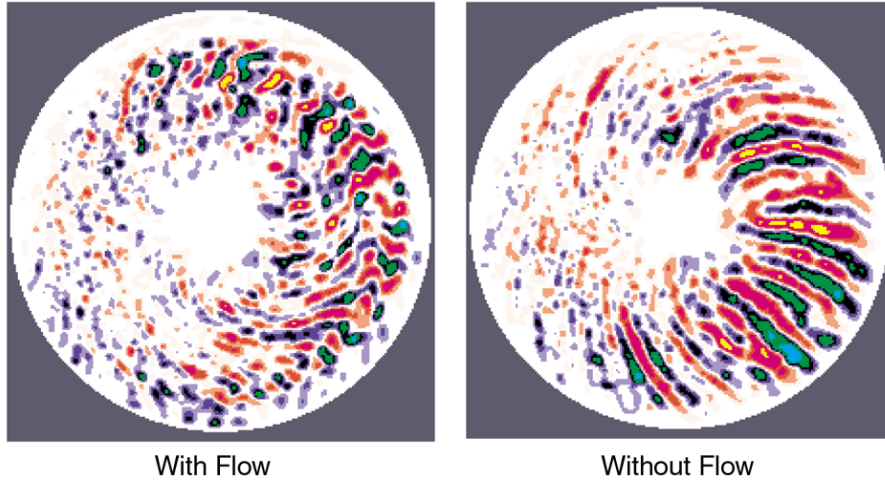

Simulations showing turbulent-like eddies disrupted by strongly sheared plasma flow.

Near Term ≤ 5 years

- Understanding the role of meso-scales in plasma turbulence and the potential impact on transport.
- Document dynamo effects in reversed-field-pinch (RFP) devices.
- Tests of shear flow amplification and flow drive by radio frequency (rf).
- Documenting the coupling of edge plasma turbulence with scrape-off layer (SOL).
- Reduced models of electrostatic turbulence applied to core transport.

Midterm ~ 20 years

- Control of turbulence in magnetically confined plasmas.
- Computational modeling of turbulence in tokamaks incorporating core and SOL.
- High-resolution core electrostatic turbulence calculations.
- High-resolution edge electromagnetic turbulence calculations.
- Development of high-resolution two-dimensional (2-D) diagnostics for imaging.
- Systematic documentation of plasma core turbulence in fusion devices.
- Magnetic turbulence measurement in hot plasmas.

Long Term > 20 years

- Computational modeling of turbulence in tokamaks incorporating core and SOL with high resolution.
 - Full electromagnetic modeling of turbulence.
 - Systematic visualization of 3-D turbulence in experiments.
 - Fusion reactor operation with turbulence control systems.
-

S-5. HYDRODYNAMICS AND TURBULENCE

Description

Hydrodynamics and turbulence represent a very important subset of the physics issues important to inertial fusion confinement (ICF) and inertial fusion energy (IFE) target design. Understanding and controlling the time-dependent evolution of hydrodynamic instabilities and ICF/IFE capsule implosion are crucial to designing a high-gain target design. It is generally agreed that successful ICF/IFE target implosions will require minimizing the effects of hydrodynamic instabilities on target performance.

Status

- To a large extent the majority of the work accomplished in the area of understanding hydrodynamic instability in high-energy density systems has been carried out as part of the Department of Energy (DOE)–Office of Defense Programs (DP) ICF and Core Weapons Physics Programs. This work has focused on understanding the temporal evolution of the Rayleigh-Taylor (RT) and Richtmyer-Meshkov (RM) instabilities.
- Significant progress has been made by the ICF program in understanding the linear and “quasi-to-near” nonlinear RT instability in ablatively driven systems. This work has included two-dimensional (2-D) and three-dimensional (3-D) perturbations.
- As part of the DOE–DP Core Weapons Physics programs, significant work is being devoted to understanding the temporal evolution of hydrodynamic instabilities from the linear regime to turbulence. A significant portion of this work is experimental investigation of these phenomena. The facilities used in this work range from “classical fluid” experimental facilities, such as shock tubes, to high-energy density systems, such as laser-driven experiments.

Current Research and Development (R&D)

R&D Goals and Challenges

- For ICF/IFE target implosions the goals and challenges remain understanding and controlling/minimizing the development of hydrodynamic instabilities that could affect the overall target gain performance. This work requires understanding the seeds for the instabilities as well as the temporal development of those seeds.
- In the area of indirectly driven ICF, significant progress has been made in understanding the development of hydrodynamic instabilities in imploding systems. The challenges are now moving to fabricating targets (cryogenic) to meet the surface finish requirements set by the need to limit the effect of hydrodynamic instabilities.
- In the area of direct-drive ICF, significant progress has been made in understanding the temporal evolution of hydrodynamic instabilities in these implosion systems. The significant challenges become controlling the seed to the instabilities and arriving at capsule designs that minimize the growth of the instabilities while still achieving acceptable levels of gain. For directly driven implosion systems, this encompasses perturbations due to both target fabrication as well as laser nonuniformities (imprinting). The capsule fabrication issues for direct drive are similar to indirect drive. Laser imprinting is unique to direct drive and requires beam-smoothing development for laser-driven options.

Related R&D Activities

- Coordination with the work being performed on understanding hydrodynamic instabilities as part of the DOE–DP core weapons program.
- Coordination with the code development being carried out under the DOE–DP Advanced Strategic Computing Initiative (ASCI) Program. A major objective of this work is improved hydrodynamic instability modeling in both 2-D and 3-D as well as the development of subgrid-scale mix/turbulence models for use in these codes.

Recent Successes

- In the area of laser-driven indirect-drive designs, significant understanding of the linear to quasi-to-near nonlinear development of the ablatively driven RT instability has been demonstrated. This work and understanding was critical in helping to convince numerous scientific peer review committees of the readiness to move forward with the National Ignition Facility (NIF). This work and understanding also has direct relevance to indirectly and directly driven heavy ion fusion designs.
- In the area of directly driven systems, significant progress has been made in understanding and controlling the imprinting caused by laser nonuniformities.
- Modern 3-D hydrodynamic codes have been developed as part of the DOE–DP ASCI Program.

Budget

- DOE–OFES: FY 1999 = ~\$9M (~\$0.5M for target design).
 - DOE–DP-ICF: FY 1999 = ~\$500M including NIF construction (~\$7–10M for target physics/design related activities).
-

Anticipated Contributions Relative to Metrics

Metrics

- For IFE, identification of target designs coupled with reactor systems that meet the requirements for the competitive cost of electricity for commercial power are anticipated. With respect to hydrodynamic instabilities in directly driven systems, this will require increased experimental data in a number of critical areas as well as integrated multidimensional design simulations.
- Understanding and control of perturbation seeds and temporal evolution of hydrodynamic instabilities are anticipated so as to be able to achieve ignition and thermonuclear gain using ICF.

Near Term ≤ 5 years

- Important experimental results are expected in the area of direct-drive laser-driven target performance from the Omega and Nike laser systems. This work will be related to identifying and controlling the sources of the initial perturbations as well as understanding the linear and nonlinear evolution of those instabilities.
- Significant theoretical and experimental work will be performed during this period by the DOE–DP Core Program toward the understanding of hydrodynamic instabilities and turbulence. This work is directed toward understanding the more complicated problem of highly nonlinear flows and transitions to turbulence. Improved understanding, numerical simulation algorithms, and mix models are a potential outcome of this effort.
- Improved 2-D and 3-D hydrodynamic codes will become available for use in this time period. During this time period, these new codes will not be fully validated against experimental data and “benchmark” simulation results. This process will continue beyond the 5-year time period. These codes will be funded entirely by the DOE–DP ASCI.

Midterm ~20 years

- Of major importance during this time period will be the experiments to obtain ignition using both indirect- and direct-drive laser-driven targets on the NIF. These experiments will help define the feasibility of the indirect- and direct-drive approaches for fusion energy and will serve as the “test” of our integrated understanding of hydrodynamic instabilities in ICF systems.
- Once ignition is achieved on the NIF, IFE relevant target design concepts would be tested during this time period. These experiments could be used to explore the instability “limits” presently being placed on ignition designs. This work could lead to improved target performance and/or reduced target fabrication and/or beam-smoothing requirements.
- Significant theoretical and experimental work will be performed during this period by the DOE–DP Core Program toward the understanding of hydrodynamic instabilities and turbulence. This work is directed toward understanding the more complicated problem of highly nonlinear flows and transitions to turbulence. Improved understanding, numerical simulation algorithms, and mix models are a potential outcome of this effort.
- Mature and validated 3-D codes will be used for IFE target designs.

Long Term >20 years

- An IFE fusion power plant will be developed.

Proponents’ and Critics’ Claims

Proponents claim that work carried out as part of the DOE–DP effort into indirect-drive ICF shows that this approach to IFE is viable and that hydrodynamic instabilities (both their seeds and evolution) can be controlled.

Currently the criticism surrounding the use of the ICF concept for fusion energy range from “it will not work at energy scales relevant to fusion applications” to “it will not be possible to be cost competitive with other approaches for producing energy in the future.” With respect to hydrodynamic instabilities, critics cite that the small energies (and small margins) required for ICF hydrodynamic instabilities cannot be controlled to the level required to achieve ignition and significant thermonuclear burn. With the NIF coming on-line in the near future, the community will be in a much better position to answer the criticism for both indirect- and direct-drive ICF capsule implosions.

Description

The dynamo describes processes that lead to the generation and sustainment of large-scale magnetic fields. The area of most intense theoretical examination is the turbulent dynamo, the production of large-scale magnetic fields due to turbulent fluid motions. Dynamo studies originated in astrophysical studies to explain the existence of cosmic magnetic fields associated with planets, stars, and galaxies, where the presence of magnetic fields is inconsistent with simple predictions using a resistive Ohm's law. Dynamo processes play an important role in sustaining the magnetic configurations of low-field magnetic confinement devices.

A topic related to the dynamo is plasma relaxation, where the plasma self-organizes into a preferred state. Self-organization is related to selective decay processes, where the effects of small amounts of dissipation cause different rates of decay for invariants of the dissipationless systems. In decaying turbulence described by three-dimensional (3-D) magnetohydrodynamics (MHDs), energy decays relative to magnetic helicity, which predicts that systems relax to large-scale, static configurations where the magnetic field and plasma current are aligned.

Status

The most successful use of relaxation theory in fusion science is due to J. B. Taylor, who predicted the preferred minimum energy state of the reversed-field-pinch (RFP). RFPs and spheromaks rely on dynamo processes to sustain their configurations on times that are long compared to the resistive diffusion timescale. The selective decay hypothesis of relaxation theory requires experimental verification. No definitive experiment has convincingly demonstrated the existence of kinematic dynamos, the spontaneous growth of magnetic fields from fluid motions. The presence of dynamos is indicated in low magnetic field confinement configurations.

Theoretical and numerical studies have developed a number of powerful concepts related to MHD turbulence and the turbulent dynamo including turbulent cascades and the Alfvén effect for small-scale fluctuations. Theory and simulations suggest that the kinematic dynamo is suppressed when self-consistency effects, due to Lorentz force back reactions, are accounted for. Efforts to extend the theoretical studies beyond MHD models have suggested interesting two-fluid effects, which involve relaxation phenomena involving plasma momentum.

Current Research and Development (R&D)

R&D Goals and Challenges

- Validate definitively and experimentally the selective decay processes.
- Observe turbulent cascades and spectrum in both observational astrophysical settings and fusion configurations.
- Identify and characterize different dynamo mechanisms (MHD vs two-fluid effects).
- Quantify Lorentz force back-reaction/self-consistency effects.
- Provide a detailed theoretical understanding of the relationship between dynamos and relaxation.

Related R&D Activities

Dynamo and relaxation concepts are generally applicable to low magnetic field configurations, such as the RFP and spheromaks, as well as aspects of astrophysical plasmas, major and minor disruptions in tokamaks, and internal relaxation events (IREs) in spherical toruses.

Successes

- The Taylor state of the RFP.
 - The presence of fluctuation-induced dynamos in low-field magnetic confinement experiments.
 - Two-fluid generalizations of MHD models.
 - State-of-the-art computer simulations.
-

Anticipated Contributions Relative to Metrics

Metrics

- Use a deeper understanding of the dynamo processes in such a way as to control and/or improve low-field magnetic confinement devices.
- Gain a better understanding of the relationship between astrophysical, geophysical, and laboratory plasmas dynamo/relaxation phenomena.
- Elucidate the transition from kinematic dynamo and self-consistent dynamos including the Lorenz force back reaction.

Near Term ~5 years

- Experimentally test mean fluctuation effects on current profile evolution in low-field configurations.
- Experimentally test the selective decay hypotheses of relaxation theory.
- Demonstrate the ability to control magnetic relaxation and improve the confinement properties of low-field magnetic configurations.

Midterm and Long Term ~20+ years

- Validate experimentally the kinetic dynamo and growth from nonmagnetic field sources.
- Demonstrate experimentally the sustainment of the magnetic field in a quasi-equilibrium state.
- Incorporate and understand non-MHD physics in the dynamo process.
- Establish rigorous conditions for the onset of the kinetic dynamo.
- Establish rigorous conditions for the use of relaxation hypotheses.
- Establish a firmer connection between relaxation phenomena in low-field devices with relaxation phenomena in higher field configurations such as tokamak sawteeth and major disruptions and IREs in spherical toruses.

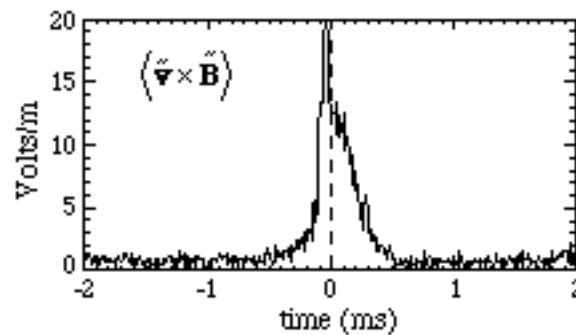

Dramatic peaking of the MHD dynamo during a sawtooth relaxation event in the MST RFP experiment.

Description

In plasma systems in which the magnetic field or a component of the magnetic field reverses direction, the system evolves to tap the magnetic free energy by cross connecting the reversed components of the magnetic fields forming a topological x-configuration. The reversed magnetic field effectively annihilates itself and converts the released energy to heat and high-speed flows. Magnetic reconnection provides the free energy for many phenomena, including solar flares, magnetospheric substorms, and sawteeth in tokamaks. In the space and astrophysical context, the importance of the phenomena is linked to the energy released, but in most laboratory situations the major issue is the energy and particle transport produced by the changing magnetic topology.

Status

In most of the physical systems the release of energy during magnetic reconnection occurs in a near explosive manner after a slow buildup of the magnetic energy in the system. The focus of research has been directed toward understanding the reason for the sudden onset and trying to explain the fast release. The onset issue remains murky, but there has been significant progress in understanding the rate of energy release. The essential problem is that the change in topology of the magnetic field that occurs during reconnection requires the frozen-in flux condition to be broken, which is mediated by some sort of dissipative process. In the systems of interest, however, the plasma is essentially collisionless. The scientific challenge is therefore to understand how the frozen-in condition is broken in collisionless plasma in a way that will yield the fast rates of magnetic reconnection seen in the observations.

The development of powerful new computational tools such as particle, hybrid (particle ions and fluid electrons), and two-fluid codes in two- and three-dimensions (2- and 3-D), combined with new analytical and physical insights have led to a tentative explanation of the fast rates within the context of the 2-D models. The rate of reconnection is apparently a universal constant of around $0.1 C_A$ (the inflow velocity) with C_A the Alfvén velocity, independent of the mechanism that breaks the frozen-in condition. Whistler and kinetic Alfvén waves play key roles in producing fast reconnection because they dominate the dynamics at small scales where the frozen-in condition is broken.

There is a rapidly expanding effort to explore and understand magnetic reconnection in laboratory experiments and to use data from satellites in the Earth's magnetosphere and from remote observations of the solar corona. Two existing experiments (at Princeton Plasma Physics Laboratory and Swarthmore) have ongoing efforts to measure flow rates and the structure of the dissipation region where the frozen-in condition is broken and other experiments are being proposed (Massachusetts Institute of Technology and University of California–Los Angeles).

Current Research and Development (R&D)**R&D Goals and Challenges**

There is a fairly broad consensus that the tools—experimental, theoretical, and computational—could be marshaled to solve the magnetic reconnection problem. The solution would require, however, a concerted effort using all three of these tools in a truly interactive program. The theoretical and computational models have led to very specific predictions for the structure of the dissipation region, which must be tested with laboratory experiments to gain confidence in the models.

There is much interest and activity now in trying to understand the influence of the full 3-D problem. Specifically, the 2-D models lead to spatially localized regions of intense current carried by both species of particles in the dissipation region. These current layers are very likely to develop instabilities driven by the locally large gradients and become fully turbulent. There is observational evidence that this is the case from laboratory experiments, satellite measurements, and some of the recent 3-D simulations. Whether one can characterize this turbulence as an anomalous resistivity or an anomalous viscosity remains to be determined and is one of the premier outstanding unanswered questions related to this problem.

Related R&D Activities

Magnetic reconnection is important in many plasma systems, and efforts are therefore ongoing to understand this phenomenon in a variety of contexts. Particularly strong efforts are in space physics, in magnetospheric physics in developing models of the dynamics of the magnetopause and the magnetotail, and in the solar atmosphere in trying to understand flares and coronal mass ejections.

Anticipated Contributions Relative to Metrics

Metrics

As discussed previously, a major deliverable is to finally pin down the rate of magnetic reconnection in collisionless plasma systems. The understanding of this rate is very likely generic to a broad range of applications: the observations appear to support such a claim because the explosive character of reconnection is ubiquitous. In the fusion program reconnection during sawteeth and disruptions in tokamaks and during dynamo action in the reversed-field-pinch (RFPs) remain incompletely understood. In magnetospheric physics, the structure and transport of plasma at the magnetopause and in the magnetotail are linked to collisionless reconnection. In solar physics, models of flares, CMEs, and the source of energy heating the corona are fundamentally linked to reconnection. Finally in astrophysics anomalous transport of angular momentum in accretion discs is controlled by the nonlinear dynamics of the magnetic field, and reconnection is an intrinsic player in this dynamics.

Midterm ~5 to 20 years

A dedicated theoretical/computational/experimental program could answer many of the key generic questions on magnetic reconnection: rates and the role of anomalous resistivity or viscosity on a 10- to 15-year time frame. The onset issues may not be generic and therefore must be explored in the context of individual programs.

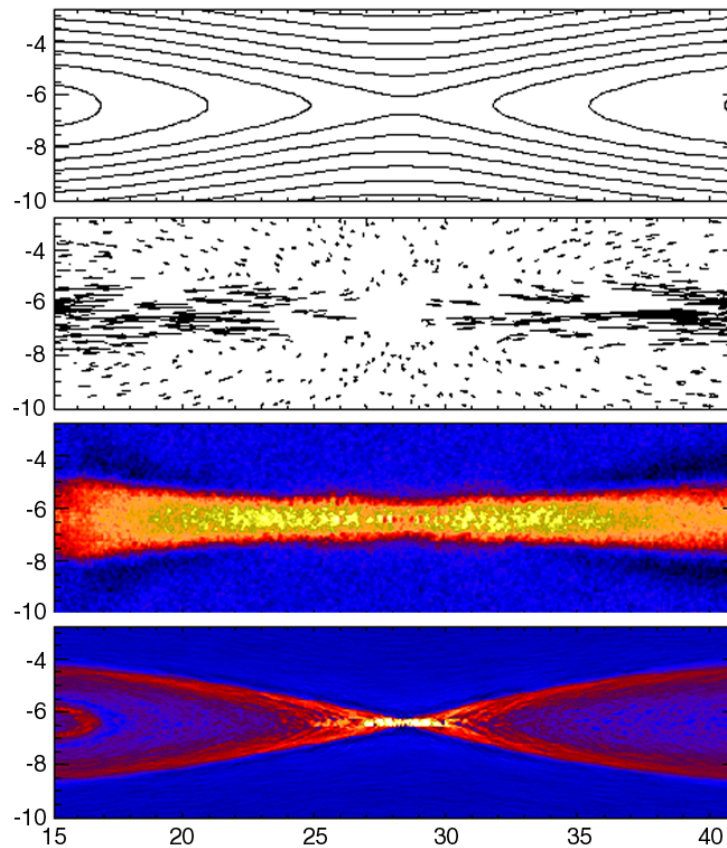

Energy and particle transport produced by changing magnetic topology.

S-8. DENSE MATTER PHYSICS

Description

An accurate equation of state (EOS) for many materials at extreme conditions is vital to any credible inertial confinement fusion (ICF)/inertial fusion energy (IFE) target design and weapons physics in Department of Energy–Defense Programs (DOE–DP). Currently very few materials have their high-pressure (greater than a few megabar) EOS experimentally validated and even then only on the principal Hugoniot function. Compressing matter to extreme densities also provides a testing ground for planetary science and astrophysics; creates new avenues for producing super hard, superconducting, or energetic materials; and may lead to new low-temperature fusion techniques not yet explored. For planetary and stellar interiors, compression occurs from gravitational force so that the material state follows a line of isentropic compression (ignoring phase separation). On earth, high densities are achieved with either static compression techniques (i.e., diamond anvil cells) or dynamic compression techniques using large laser facilities, pulse power machines, gas guns, or explosives.

Status

Dynamic compression experiments have made great strides in recreating material states that exist in the outer 25% (in radius) of the Jovian planets, near the core of earth, and at the exterior of low-mass stars. Large laser facilities have recently shown success at producing and characterizing material EOS at significantly higher pressures than gas guns (plastic Hugoniot to 40 Mbar and near 3 Mbar for deuterium). Both direct and indirect drive have been used to generate well-characterized shocks. Several experimental techniques have also recently been developed: radiography (to determine opacity), optical conductivity, temperature, displacement, X-ray diffraction, and velocity-/displacement-sensitive interferometry are some of the diagnostics currently used in laser-generated shock EOS experiments. While gas gun drivers currently produce the most accurate shock EOS data, they are limited to much lower pressures: <10 Mbar for high-density materials and <300 Kbar for low-density materials. As laser technology improves the accuracy, statistics will likely exceed gas gun technology even at lower pressures. Pulsed-power facilities (like the Z accelerator at Sandia National Laboratory) have demonstrated shock pressures of about one-tenth those from lasers (though still higher than conventional gas guns) but with a larger spatial scale (though much smaller than gas guns). Continuing effort is being made toward characterizing drives for compression measurements.

Current Research and Development (R&D)

R&D Goals and Challenges

(1) Generate and calibrate drives (steady/planar shocks, isentropic compression, and release profiles) for indirect and direct drive with large laser facilities, smaller tabletop lasers, and pulse power schemes. (2) Map out the EOS over broad regions of material phase space, ranging over elements and compounds important to weapons, planetary science, neutron stars, white and brown dwarf stars, solar interiors, ICF, IFE, and materials that may produce technologically advanced properties (i.e., room-temperature superconductor) in compressed phases. (3) Characterize phase transitions such as freezing, structural, electronic (metallic-insulator), and magnetic, and determine their order. (4) Develop an experimentally validated model(s) for transport properties at extreme densities. This requires accurate knowledge of electron-ion coupling, which appears to be in disagreement with theory even at modest shock pressures/densities for some materials. (5) Answer specific questions relating to giant planets: What is the cause of excess infrared radiation, the nature of the strong magnetic fields with nondipolar component, and interpretation of recent Pioneer data? (6) Understand earth-type planetary interiors, in particular, transition layer-transition properties and core-transition properties. (7) Explore high-density chemistry (chemical reactions and phase stability). (8) Determine how ionization states change with density and implications on opacity. (9) Test pycnonuclear fusion and other new fusion scenarios that are thus far completely theoretical. (10) Determine why different regions of phase diagrams appear to be inaccessible in both static and dynamic experiments (kinetics?). Can we get around the roadblocks preventing access to equilibrium/nonequilibrium phases? (11) Combine technologies (such as diamond anvil plus laser) to achieve lower entropy compression.

Related R&D Activities

- Applied integrated experiments are being conducted to test available physics packages in both the ICF program and DOE–DP core weapons program.
- Code developments under the Advanced Strategic Computing Initiative (ASCI) program are focused toward modeling fundamental interactions (i.e., compressed quantum fluids using path integral techniques) and integrated simulations.

Recent Successes

- Techniques to produce accurate laser-driven shock experiments have been developed. These techniques were used to compress and characterize liquid hydrogen isotopes into the atomic metallic phase. They achieved shock pressures greater than 3 Mbar, temperatures greater than 30,000 K, and densities exceeding 1 g-cm^{-3} . Absolute EOS measurements of other low-Z materials have been made up to 40 Mbar.
- Wave profiles and reflectivity of both the interface and shock front have revealed electronic transitions and structural transitions for a few materials.

Budget

- \$8M to \$10M for the EOS of a range of materials under extreme conditions for DOE–DP applications.
- <\$1M for fundamental studies of dense matter physics.

Anticipated Contributions Relative to Metrics

Metrics

- Develop EOS models accurate enough for weapons physics work, ICF ignition target designs, and high-energy-density science.
- Develop and produce advanced materials that can provide large cost reductions or new capabilities in technology.

Near Term <5 years

- Use existing facilities (Omega, Nike, Trident, Z) to improve shock steadiness, shock planarity, isentropic compression drives, and accuracy for Hugoniot and off-Hugoniot experiments. Continue to experimentally validate EOS packages for low Z materials to allow accurate ICF ignition target design and weapons physics. Learn to recover shock-compressed materials. Combine static experiments with rapid heating/shock capability.
- Conduct theoretical work to treat many-particle, strongly coupled quantum systems with finite-length scales (both low and moderate temperatures). Better theoretical understanding of chemical exchange at high pressure.
- Understand simple s->d transitions (hybridization of valence electrons) in both static and dynamic experiments.
- Probe chemical reaction paths in both static and dynamic experiments.
- Determine e-ion coupling at moderate pressures (~20 Mbar).

Midterm ~20 years

- Produce experimentally validated and fundamentally understood EOS generators for materials used in IFE, ICF, and weapons physics, and high-energy-density science.
- Test proof-of-principle pycnonuclear fusion, and compare reaction rates with statistical predictions.
- Synthesize energetic materials for advanced rocket propellants (perhaps metallic hydrogen fuel pellets), explosives, or reusable energy sources. Synthesize superhard (such as a predicted C₃N₄ phase) and room-temperature superconducting (perhaps O₂ or NbSi₃) materials.
- Recreate and characterize planetary and low-mass star atmospheres and cores.

Long Term >20 years

- Develop industrial-grade (fieldable) energetic materials and superhard and superconducting materials.
- Cultivate pycnonuclear fusion.
- Develop the ability to design/fabricate material properties (strength, magnetization, and conductivity).

Proponents' and Critics' Claims

Proponents claim that by tuning shocks/compression profiles, such as those required for tuning ignition targets on the National Ignition Facility (NIF), we will be able to experimentally validate EOS models over a continuum of pressures/densities, as well as synthesize new materials with technologically rich properties.

Critics claim that the low shot rate will make it impractical to explore much material phase space. Critics also ask whether EOS measurement accuracy will be sufficient to differentiate between EOS theories of similar predictions. Proponents argue that the regimes accessible with these facilities are completely unexplored in the laboratory and will likely elicit surprises, as in the case of megabar hydrogen isotopes.

S-9. NONNEUTRAL PLASMAS

Description

Nonneutral plasmas are many-body collections of charged particles in which there is not overall charge neutrality. Such systems are characterized by intense self-electric fields and in high-current configurations, by intense self-magnetic fields. Single-species plasmas are an important class of nonneutral plasmas. Examples include pure ion or pure electron plasmas confined in traps and charged particle beams in high-intensity accelerators and storage rings. Single-species plasmas have excellent confinement properties and can be confined for hours or days. Therefore, controlled departures from thermal equilibrium can be readily studied. Single-species plasmas also provide an excellent test bed for fundamental studies, such as transport induced by like-particle collisions, non-linear dynamics and stochastic effects, vortex formation and merger, plasma turbulence, and phase transitions to liquidlike and crystalline states in strongly coupled pure ion plasmas.

Status

The many diverse applications of nonneutral plasmas have resulted in synergies of research efforts in several subfields, including plasma physics, atomic physics, chemistry, fusion research, and high energy and nuclear physics. Applications of single-species plasmas include accumulation and storage of antimatter (e.g., positrons and antiprotons) in traps; development of a new generation of precision atomic clocks using laser-cooled pure ion plasmas; precision mass spectrometry of chemical species using ion cyclotron resonance; coherent electromagnetic wave generation in free electron devices (magnetrons, cyclotron masers, free electron lasers); high-intensity accelerators and storage rings, with applications including heavy ion fusion, spallation neutron sources, tritium production, and nuclear waste treatment; and advanced accelerator concepts for next-generation colliders.

Current Research and Development (R&D)

R&D Goals and Challenges and Related R&D Activities

- Understanding of transport induced by like-particle collisions and collisions with neutral atoms in trapped single-species plasmas.
- Vortex dynamics, relaxation of turbulence, and simulation of two-dimensional Euler flows in trapped single-species plasmas.
- Storage and properties of positron and antiproton plasmas and the formation of neutral antimatter (antihydrogen).
- Coulomb crystals and strongly coupled pure ion plasmas.
- Laser cooling of one-component plasmas in storage rings.
- Ordered structures in dusty plasmas.
- High-intensity charged particle beam propagation in accelerators and storage rings for heavy ion fusion, spallation neutron sources, and tritium production.
- Fusion applications of dense nonneutral plasmas.

Recent Successes

- Development of rotating-wall techniques to extend confinement time of single-species plasmas to long (one-week) periods.
- Characterization of transport due to like-particle collisions in single-species plasmas.
- Characterization of single-species plasma expansion due to collisions with background neutral atoms.
- First controlled experimental identification of autoresonance in a collective plasma mode.
- Bragg scattering studies of laser-cooled pure ion plasma crystals in a Penning trap.
- Development and application of plasma wave echoes as a diagnostic of proton and antiproton synchrotron beams.
- Development of techniques for positron storage and studies of collective processes in electron-positron plasmas.
- Trapping and cooling of antiprotons to 4.2 K.
- Nonlinear stability theorem developed for quiescent propagation of high-intensity charged particle beams or charge bunches over large distances.

Budget

Funding for these diverse areas of research is provided primarily by the Office of Naval Research, the National Science Foundation, and the Department of Energy.

Anticipated Contributions Relative to Metrics

Metrics

Research in nonneutral plasmas involves interdisciplinary activities among several fields, including plasma physics, atomic physics, chemistry, high energy and nuclear physics, and fusion research. The metrics for assessing the impact of this research necessarily cut across broad areas of basic and applied physics. Metrics for assessing the scientific and technological contributions include the following:

- Understanding transport due to like-particle collisions.
- Understanding vortex dynamics and control of collective plasma processes and turbulence.
- Understanding single-species plasma expansion due to collisions with neutral atoms.
- Relationship of single-species plasma behavior to that in two-component nonneutral and nearly neutral plasmas.
- Properties of strongly coupled single-species plasma and Coulomb crystals.
- Precision atomic clocks.
- Precision mass spectrometry.
- Confinement of charged antimatter (positrons, antiprotons) and applications such as materials characterization using trapped positrons.
- Properties of atomic antimatter (antihydrogen) and the dynamics of electron-positron plasmas.
- Compact, portable traps for single-species plasmas.
- High-intensity accelerators for heavy ion fusion, spallation neutron sources, and tritium production.
- Advanced accelerator diagnostic techniques using collective excitations.
- Advanced accelerator concepts for next-generation colliders.
- Fusion applications of dense nonneutral plasmas.

Near Term ~5 years

- Detailed understanding of collisional transport of heat and momentum in single-species plasmas.
- Detailed understanding of vortex dynamics and two-dimensional Euler flows in single-species plasmas.
- Understanding of transport in two-component nonneutral and nearly neutral plasmas.
- Improved high-vacuum pressure measurements by monitoring the expansion of pure electron plasmas due to collisions with neutral atoms.
- New generation of precision atomic clocks using laser-cooled, strongly coupled pure ion plasmas with applications as diverse as navigation and tests of general relativity.
- Compact, trapped-positron source for materials characterization and other applications.
- Creation and trapping of antihydrogen in sufficient abundance to measure atomic properties with high precision.
- Confinement of nonneutral electron-positron plasmas.
- Improved precision mass spectrometry techniques for chemical species using ion cyclotron resonance in pure ion plasmas.
- Miniature radio frequency (rf) (Paul) traps using microchip technology.
- Detailed understanding of conditions for stable propagation of high-intensity charged particle beams over large distances (kilometers), including development of techniques for minimizing halo particles.
- Development and testing of at least one, plausible exploratory fusion concept based on the magneto-electric confinement of dense, pure ion plasmas.
- Development of an improved suite of plasma-based techniques for diagnosing properties of charged-particle beams in high-intensity accelerators.

Long Term 5–15 years

- Precision experimental tests of CPT invariance and gravitational acceleration of antimatter.
 - Study of low-energy antihydrogen-matter interactions.
 - Portable traps for transportation of positrons and antiprotons.
 - Potential commercialization of new nonneutral plasma-based devices for applications such as ultrahigh-vacuum pressure measurement, mass spectrometry, atomic clocks, and positron characterization of materials.
 - Demonstrated control of beam transport, stability, and halo formation in the heavy ion fusion Integrated Research Experiment (IRE), the Spallation Neutron Source (SNS), and the Accelerator for Production of Tritium (APT).
 - Experimental test at proof-of-principle level of one fusion concept using dense, pure ion plasmas.
-

S-10. ELECTROSTATIC TRAPS

Description

Electrostatic traps use either a physical grid (as pictured) or a virtual cathode formed by primary electrons in a Penning-type trap to confine, accelerate, and direct ions toward a focus (usually in a spherical geometry). Ions are formed by glow-discharge operation, by electron impact on neutral fill, or in an external ion source. To produce fusion-relevant conditions, high voltages (>50 kV) and relatively small sizes (few millimeters to few centimeters) are required, making electrical breakdown a critical technology and science issue. The small size and relatively simplicity of these systems make them useful as portable sources of deuterium (D)-D or D-tritium (T) fusion neutrons. A unique fusion reactor concept uses a massively modular array of such sources operating at high Q to solve fusion engineering problems of high wall load, high activation, and tritium production.



Commercial IEC neutron generator from
<<http://www.dasa.com/fusionstar>>

Status

Traps using a physical grid [usually called inertial electrostatic confinement (IEC) machines] have demonstrated useful neutron outputs to the point where assay system and even commercial applications are now under way. Daimler-Benz Aerospace (DASA) has developed a commercial D-D unit that is virtually ready for market. Virtual cathode machines [usually called Penning Fusion (PF) machines] have demonstrated required physics goals of maintaining required nonthermal electron distributions, spherical focusing, and excellent electron energy confinement, and they are poised to attempt to study ion physics.

Current Research and Development (R&D)

R&D Goals and Challenges

IEC systems attempt to increase the ion recirculation. Two approaches that are being pursued are to decrease the working pressure and to form a central ion well by operation at high perveance ($I/V^{3/2}$). For the low-pressure case, the enabling science is producing and handling large primary electron currents. The primary physics effect is that collisions of ions with neutrals are minimized, leading to a higher mean ion energy. For the central well case, the enabling science is pulsed operation, which allows large peak currents with limited thermal loading of the grid. Preliminary data from D-D fusion proton production profiles need to be confirmed with higher resolution measurements and better understood theoretically and experimentally.

PF systems attempt to tailor the electron cloud to produce a spherical ion well, while maintaining desired excellent electron confinement. In addition to the steady ion convergent mode of IEC machines [spherically convergent ion focus (SCIF)], PF systems potentially may access a recently discovered oscillating ion mode [periodically oscillating plasma sphere (POPS)], if a *uniform* density electron cloud is formed with appropriate electrostatic boundary conditions.

Both approaches attempt to raise the ion well depth by increasing the applied voltage.

Related R&D Activities

PF systems are employing a branch of nonneutral plasma physics to obtain required nearly absolute electron confinement in a (sub)centimeter-sized system.

Recent Successes

- Importance of charge-exchange on IEC physics quantified.
- Preliminary observations of central ion well in IEC.
- POPS ion mode theoretically avoids Q limitations from ion-ion collisions.
- PFX demonstrated super-Brillouin spherical electron focus.
- Massively modular POPS reactor concept developed.

Anticipated Contributions Relative to Metrics

Metrics

- Physics
 - Ion well depth
 - Mean number density
 - Convergence (system size to focus radius)
- System/Technology
 - Electrical breakdown resistance
 - Neutron output
 - Lifetime
 - Q
- Science
 - Super-Brillouin nonneutral plasmas
 - Ultrashort energetic neutron pulses (POPS)

Near Term ≤ 5 years

A large (multimillion dollar) commercial market exists for plasma-based neutron sources. Advantages over existing beam-target sources are low or no radioactive inventory, greatly increased lifetime, and high Q operation (compared to 10^{-4} beam-target efficiency). With miniaturization and efficiency offered by the PF or other approaches yet to be developed, this market expands to several billion dollars, as applications to petroleum reservoir logging and production of medical isotopes become accessible.

Near-term R&D goals relative to metrics follow:

- Ion well depth of 50 kV
- $\langle n \rangle$ of 10^{18} m^{-3}
- Convergence of 100:1
- Applied voltage >100 kV
- Mean neutron rate of $>10^{11}/\text{s}$
- Lifetime of >1000 h
- $Q > 0.01$
- Reactivity 1000 Brillouin
- Study POPS

Midterm ~ 20 years

- Raise $Q > 1$.
- Demonstrate massively modular approach.

Long Term >20 years

Deliver fusion power system for high-value applications, such as space power.

Proponents' and Critics' Claims

Proponents claim these advantages:

- Compact, cheap, simple, and incremental R&D path
- Range of near- and medium-term applications
- "Arbitrarily" small fusion power reactor embodiment
- Advanced fuel operation
- High Q operation possible with POPS

Critics note these limitations:

- Electrical breakdown limits insurmountable
 - Q limited by ion-ion collisions
 - Small size inappropriate for fusion power application
-

S-11. ATOMIC PHYSICS

Description

Atomic collision and radiation processes critically influence the dynamics of heating, cooling, confinement, particle transport, and stability of high-temperature core plasmas, as well as low-temperature edge and divertor plasmas of magnetically confined fusion devices. Accurate atomic collision as well as structure data are essential for modeling such fusion plasmas and interpreting critical plasma diagnostics measurements (see Young/Diagnostics, S-14). In the core plasma, electron collisions with multicharged impurity species determine ionization balance and excited state distributions; spectroscopic measurement of these parameters, in conjunction with atomic collision data on electron-impact excitation, ionization, and recombination cross sections and atomic structure data on transition wavelengths and lifetimes, provides information on plasma temperature and impurity density. Charge exchange recombination spectroscopy (CHERS) and heavy ion beam probe diagnostics of the core and edge plasma require accurate heavy-particle charge-exchange cross sections (both total and state selective) to yield information on heavy-particle plasma constituent energy and density distributions. The recently developed radiating-divertor concept relies on atomic line radiation and other atomic processes to reduce power exhaust wall loading of the divertor to manageable levels. Because of the high density of the divertor plasma, a collisional-radiative model must be used plasma (see Griem/ICF Atomic Physics). This, in turn, requires comprehensive databases of cross sections, transition probabilities, and energy levels involving the gas-puff species and HD^+ and helium. Predictive simulations for optimizing helium-ash removal in the divertor require an extensive atomic collision database on integral elastic and transport cross sections for low-energy collisions among helium, hydrogen atoms, ions, and molecules. Because power/particle exhaust and plasma diagnostics will be central issues irrespective of the topology of the final reactor design, the atomic physics, just described in the specific context of the core, edge, and divertor plasmas of tokamaks, are obviously of pervasive importance.

Status

Good progress has been made in characterizing atomic-collision cross sections and atomic structure data pertinent to low-density high-temperature core fusion plasmas; this includes the processes of charge exchange (CEX) at kiloelectron-volt energies and above involving multicharged impurity and diagnostic ions as well as fusion products, and electron impact ionization and recombination of moderate to highly charged impurity species. This has been achieved by close coordination between experiment and theory, while seeking to identify benchmark systems for testing critical theoretical approximations and discovering useful scalings and trends along isoelectronic sequences. Significant progress has been made in facilitating access to needed atomic data by placing data resources on the World Wide Web and by coordinating among the various atomic data gathering centers worldwide the publication of compilations of bibliographic and numerical recommended atomic collision and structure data.

Current Research and Development (R&D)

R&D Goals and Challenges

Over the past few years emphasis has increased on characterization of atomic and molecular collisions relevant to the high-density and low-temperature edge and divertor plasmas, where collision times can become comparable to excited-state lifetimes. Progress has been made, by experiment and theory alike, in determination of electron-impact excitation cross sections of low-charge-state impurity ions, and first measurements of excitation from an initial, excited metastable state have been performed. Attention is being given to the study of CEX of low-charge-state intrinsic and extrinsic impurity ions with hydrogen, H_2 , and helium at electron-volt energies. Studies have been carried out, and others have been initiated on low-energy electron and heavy-particle interactions (e.g., dissociative recombination, CEX, fragmentation) with various H/D/T containing molecules and molecular ions. Efforts are under way to compile comprehensive databases of low-energy elastic scattering, momentum transfer, and viscosity cross sections for interactions involving the various ionic, atomic, and molecular constituents of the divertor plasma.

Awareness has grown of the interrelation of the atomic physics of plasma-wall interactions and the volume atomic processes occurring in the divertor plasma and of the necessity of characterizing and understanding the electronic and ro-vibrational excited-state, kinetic energy, and angular distributions of ionic, atomic, and molecular species (re)introduced into the divertor plasma as a result of plasma-wall interactions (see M-15). Despite the increased awareness, progress has been slow in this area.

Related R&D Activities

- International Atomic Energy Agency (IAEA) Coordinated Research Projects focus on fusion relevant topical areas, such as the recently established CRP on “Charge Exchange Cross Section Data for Fusion Plasma Studies.”
- The Nagoya Institute for Fusion Science (NIFS) coordinates a cooperative fusion-related atomic physics research program and maintains fusion-relevant databases on electron and CEX collisions, sputtering yields, and backscattering coefficients.
- Many AMO science activities within the Department of Energy (DOE) Basic Energy Sciences (BES) program provide data and understanding of AMO processes occurring in fusion plasmas (stewardship responsibility, according to P. Dehmer).

Recent Successes

- The understanding of external field effects, including the newly discovered influence of a moderate magnetic field perpendicular to electric fields, on di-electronic recombination of multicharged ions has been an important advance in the theory of electron collisions in fusion plasmas.
- The experimental observation and theoretical calculation of recombination resonances in the near threshold electron-impact excitation cross section show the inherent complexity of this process and the necessity of continued case-by-case evaluation. The interference of resonances is apparently common and can strongly affect cross sections.
- The development of time-dependent and time-independent close-coupling methods for the treatment of electron-impact ionization has allowed for much more accurate determination of theoretical ionization cross sections.
- Multichannel quantum-defect calculations of electron-impact excitation in intermediate coupling have made possible the theoretical determination of an accurate level-to-level excitation cross section for more complex atomic species.
- The identification of unsuspected oscillations in ion-atom inelastic (CEX, excitation, and ionization) cross sections has had significant influence on interpretations of lithium-beam and helium-beam diagnostics.

Budget

The DOE-OFES: FY 1999 = \$1.47M (essentially unchanged from FY 1998).

Anticipated Contributions Relative to Metrics

Metrics

Atomic physics will play critical roles in the physics of achieving the power and particle exhaust required for next-generation fusion devices, as well as diagnostics.

Near Term <5 to 10 years

- There is a rapidly growing need for accurate experimental and theoretical characterization of electron and heavy-particle (e.g., CEX and fragmentation) collisions with molecules/molecular-ions, to a large extent entirely lacking at present, as the role of high-density, low-temperature plasmas increases and the importance of the many constituent (molecular) species (e.g., light hydrocarbons and BeH) becomes more established and accepted.
- Experimental and theoretical determination of electron-impact excitation cross sections for low-charge-state gas-puff species and impurity ions, from initial ground as well as metastable states, will be required to provide necessary data on evaluating various radiating divertor concepts.
- Accurate low-energy state selective as well as total electron-capture cross sections will be needed for optimizing enhanced radiation loss by gas-puff species resulting from CEX recombination.
- Methods need to be developed and measurements made of excited-state, energy, angular, and mass distributions of species evolving from divertor walls, and their effect on divertor-plasma characteristics and behavior needs to be more established quantitatively.
- With the resurgence of interest in high-Z wall materials, additional scrutiny and exploration of electron and heavy-particle collision cross sections for low- to intermediate-charge state, high-Z metallic ions is needed.
- With increasingly data-intensive modeling and diagnostics, there is an increasing need for widely available, systematic, retrievable storage and evaluation that is well integrated with the fusion community.

By close coordination of experiment and theory, an electron-impact collision and atomic structure database will be developed for ground and metastable initial states of low-charge state gas-puff species as input to collisional-radiative models of divertor radiation loss. Theoretical approaches and experimental methods to characterize low-energy interactions of molecules with electrons, heavy particles, and surfaces (breakup, CEX, excitation, ionization) will be developed for more detailed modeling of the role of molecules/molecular ions in edge and divertor plasmas. New species will need to be considered in electron and heavy particle collisions (e.g., Be, Ne, Xe, Mo, BeH, C₂H₂, H₃⁺, H⁻) with concomitant improvement of the data coordination, evaluation, and dissemination process.

Near-Term Applications

The theoretical approaches and experimental techniques implemented will have direct application in modeling plasma-processing environments as well as astrophysical plasmas. Plasma processing is a potentially huge market because economic considerations will move the industry away from empirical tweaking of reactor designs to more systematic, model-based approaches.

Proponents' and Critics' Claims

Progress in magnetic fusion research had been closely coupled throughout its history with atomic physics issues having (potentially) negative as well as positive impacts. Examples of the former are the “lumpy continuum” first seen in ORMAK, which provided the first clue for the limiting effect of high-Z impurity atomic line radiation on ultimate attainable plasma temperature, and the feared neutral-beam trapping instability in the early days of neutral beam injection. In the latter camp is the radiating-divertor concept, which is evolving as a viable solution to the excessive wall power-loading problem and the crucial atomic physics foundation for many of the essential plasma diagnostics employed today. Proponents further claim that as fusion-reactor concepts evolve to include ever higher densities and lower temperatures, the role played by atomic physics will be essential for achieving optimization of fusion devices.

Despite past contributions and anticipated future requirements of atomic physics, critics claim that the ultimate success of magnetic fusion as a commercial energy source will be mainly determined by issues unrelated to atomic physics.

Description

The physics of atoms and ions in dense, high-temperature plasmas is very interdisciplinary. Its first component consists of atomic structure theory up to very heavy and multiple ionized atoms, for which relativistic and QED effects must be included. Interactions between such ions and the rest of the plasma are important not only for the equations of state and dynamical properties of dense matter (see Collins and More), but also for the radiative properties of inertial confinement fusion (ICF)/inertial fusion energy (IFE) and astrophysical plasmas. Specific ICF applications are radiation-hydrodynamics (Verdon) of pellets and X-ray hohlraums, spectroscopic diagnostics, and z-pinch X-ray sources.

A second component is required because radiated or absorbed spectra are often significantly perturbed relative to the radiation expected from isolated atoms. The ensuing spectral line broadening remains an active research area with analytic theory, various kinetic models, and computer simulations; but so far only it has relatively few well-diagnosed experiments. This seemingly narrow discipline is essential both for diagnostics and for opacity calculations.

A third, not unrelated, component of radiation physics is concerned with the kinetic modeling of charge-state and level populations. For time-dependent and inhomogeneous plasmas in a non-Planckian radiation field, this modeling requires numerical solutions of large sets of collisional-radiative rate equations coupled with many photon-bins radiative transfer equations and with (magneto-) hydrodynamics equations. The task of atomic physics in this challenging computational physics problem is to provide realistic collisional rate coefficients (cross sections in the case of non-Maxwellian electron distributions), transition energies and probabilities, photon cross sections, and line profiles.

For computational reasons, such large kinetic models are normally replaced by reduced models, that is, omission of detailed atomic structure and of highly excited states. At high densities the first simplification may be physically justified by line broadening, and the second by continuum lowering (see Collins and More), which is closely related to line broadening. An even more desirable replacement is possible if densities are high enough and effects of non-Planckian radiation fields are not too important, such that local thermodynamic equilibrium (LTE) is approached. For such situations, nonequilibrium thermodynamic, linear-response theory can be used to calculate even surprisingly large deviations from LTE with good accuracy.

Current Research and Development (R&D)**R&D Goals and Challenges**

Common goals in this area are the development of reliable opacity codes for ICF/IFE and astrophysical applications, of radiation subroutines for hydrocodes, and of detailed spectral modeling for diagnostic applications.

Major challenges are not only in the development of more realistic computer codes but also in the design and execution of benchmark experiments. Examples here are recent LTE opacity experiments on radiatively heated, well-designed, and diagnosed targets. More specific experiments on line profiles and controlled non-LTE opacities also deserve high priority and may involve similar approaches. Nonplasma (merging beams, see Meyer) benchmark experiments of important electron-ion excitation and ionization cross sections are, perhaps, even more important and could be cosponsored by MFES. This also holds for the rather direct measurements (e.g., in ion-traps) of dielectronic capture rates.

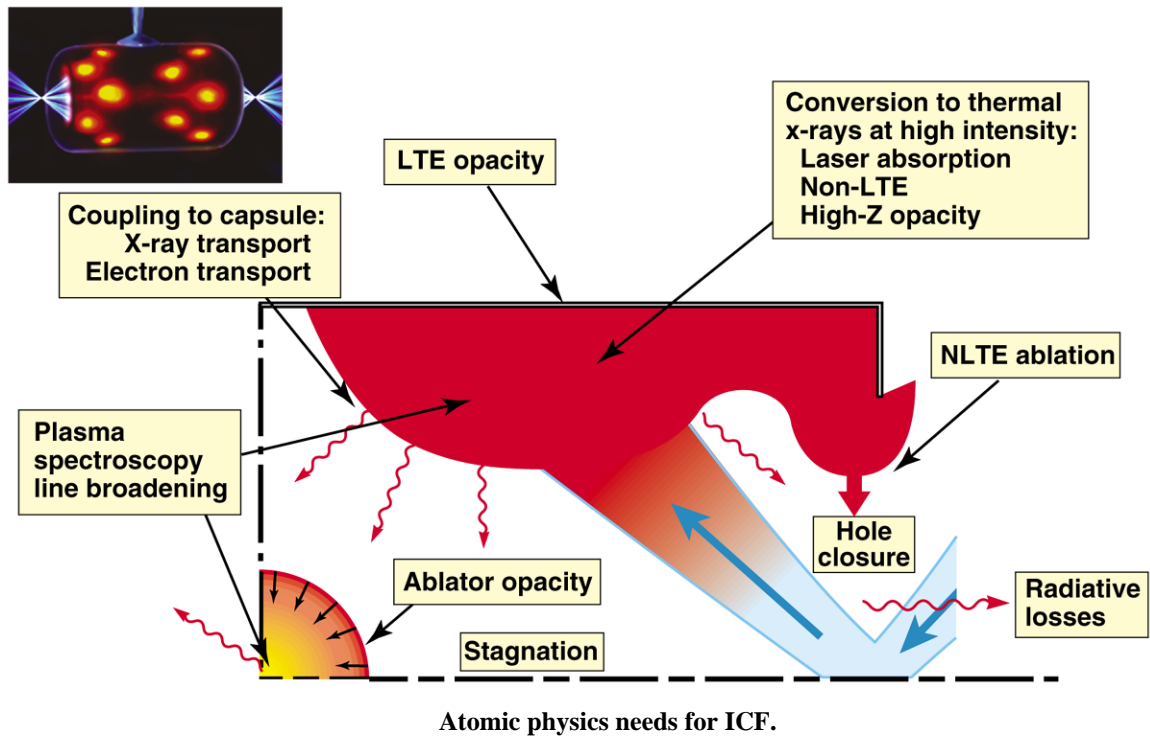

Anticipated Contributions Relative to Metrics

Midterm ~10 years

- Omega, Trident, and Nike experiments
- Z-pinch development
- Ultra-short laser experiments

Long Term >10 years

- National Ignition Facility diagnostics and modeling
- Astrophysics

Proponents' and Critics' Claims

Controversies remain concerning continuum lowering, validity of semiclassical line broadening calculations and electron-ion cross sections, and line shifts in dense plasmas.

Description

Plasma diagnostics is the generic name for the instruments used to make all measurements in a wide variety of plasma devices. They make use of electromagnetic radiation, magnetic fields, atomic and subatomic particles, and metallic probes for plasma measurements by both passive monitoring and active probing means. New technological developments have allowed significant enhancements in spatial and temporal resolutions to enable better understanding of turbulence and to identify instability drivers. Diagnostic data are used in an integrated way with analysis codes to provide the plasma properties. These data are being increasingly used for active feedback control of some plasma parameters to improve the performance and lifetime of the plasma.

Status

Major progress in the capability of plasma diagnostics has occurred in the last few years. New or improved techniques have been critical to the understanding of improved confinement regimes. Experimental observation and rapidly improving theoretical predictive modeling have led to improved diagnostic capability in spatial and temporal resolution. The rapid advance in technology, particularly in the computer power for data processing and storage, has contributed to the success in achieving the necessary measurement quality. Similar capability to that on tokamaks should now be a major requirement for alternate devices. Also techniques are desirable for the high-density low-temperature plasmas in plasma applications.

Current Research and Development (R&D)**R&D Goals and Challenges**

Examples of significant R&D challenges follow:

- Measurements of parameters relating to disruptions (e.g., runaway electrons and rapid temperature decay).
- Techniques for measuring divertor and edge plasma parameters to characterize cold plasma behavior and interaction with the wall.
- Measurement techniques for fast ions, including alpha particles, with good spatial and temporal resolution, and related parameters such as local electric fields.
- Two- and three-dimensional (2- and 3-D) techniques for measuring fluctuating parameters to lead to improved understanding relative to theory and to measured transport.
- New techniques for measuring magnetic structures, especially for alternate concept devices.
- New techniques for measuring profiles of parameters. Techniques for measuring wave propagation and deposition associated with the increasing reliance on these techniques for heating and current drive.

Related R&D Activities

- Technological developments in a very wide range of instrumentation, most of which happens commercially.
- Theoretical and modeling simulation of plasma behavior.
- Atomic cross-section measurement and theory.
- Developments in data processing and storage technology.
- Developments of diagnostics components for operation in the nuclear environment of reactor-grade devices.

Recent Successes

- Bolometry techniques for measuring radiated power with fine spatial resolution.
- X-ray imaging cameras for 2-D imaging of driven current profile.
- Methods of measuring confined and escaping alpha particles, though much further development is needed.
- Reflectometer techniques for measuring plasma density profiles and quantitative information on local density fluctuations and correlations in tokamak plasmas.
- Motional Stark effect (MSE) as a routine measurement of current density distribution.
- Precise independent measurement of poloidal plasma rotation.
- Design of a set of diagnostics for the International Thermonuclear Experimental Reactor (ITER).

Budget

Budget is provided in part by the Department of Energy (DOE)–Office of Fusion Energy Sciences directly and largely through devices funded by DOE. The direct fraction of the funding is \$4.2M.

Anticipated Contributions Relative to Metrics

Metrics

The number and performance requirements for plasma diagnostics are normally set by the experiment on which they are applied. The choice of parameters to be measured, with sufficiently good temporal and spatial resolutions, sets the requirement. In the present fusion science environment, the quality of measurements on alternate concepts should aim to match present-day tokamak capability, while tokamaks should advance with better diagnostics to improve understanding of transport and transport barriers to allow profile control and to head for steady-state operation.

Near Term ≤ 5 years

- The new diagnostics requirements listed in the section on R&D goals and challenges should be addressed, and measurements should be made using the equipment at least at the prototype level. The new alternate concept devices, especially the National Spherical Tokamak Experiment (NSTX), will require some significantly different diagnostics from tokamaks, and these will be developed and operated.
- New technology is becoming available for implementing 2-D imaging of fluctuations in the plasma, and this will greatly facilitate theoretical interpretation.
- The recent rapid improvement in diagnostics for the divertor plasmas in tokamaks should continue, and the integration of more sophisticated diagnostics (e.g., profile-measuring systems) into plasma control is an important need.

Midterm ~ 20 years

- Diagnostics within a 20-year timescale will evolve with the type of devices being built and operated. New techniques will be developed, and older techniques will evolve as new commercial components become available.
- A significant issue will be provision of sufficiently radiation-hardened, reliable diagnostics to provide control and physics information for a next-step fusion device.

Long Term > 20 years

The diagnostics in use will be operating to fulfill the mission of the devices built and operating in this time frame.

Plasma Diagnostics on Tokamak Fusion Test Reactor (TFTR)

Profile data

$T_e(\mathbf{r})$

- Multipoint Thomson Scattering (TVTS)
- Electron-Cyclotron Emission (ECE) heterodyne radiometer
- ECE Fourier Transform spectrometer
- ECE grating polychromator

$n_e(\mathbf{r})$

- Multipoint Thomson Scattering (TVTS)
- Multichannel Far Infrared Interferometer (MIRI)

$T_i(\mathbf{r})$

- Charge-Exchange Recombination Spectroscopy (CHERS)
- X-Ray crystal spectrometer

$q(\mathbf{r})$

- MSE polarimeter

Comprehensive magnetic measurements

Neutrons

- Epithermal neutrons
- Neutron activation detectors
- 14-MeV neutron detectors
- Collimated neutron spectrometer
- Multichannel neutron collimator
- Fast neutron scintillation counters
- Gamma spectrometer

Alpha particles

- Lost alpha/triton array
- Alpha-Charge-Exchange Analyzer
- Alpha-Charge-Exchange Recombination Spectroscopy (α -CHERS)

Impurity concentration

- Visible Bremsstrahlung array
- VUV Survey Spectrometer (SPRED)
- Multichannel visible spectrometer
- X-Ray pulse height analysis (PHA)

Radiated power

- Tangential bolometers
- Bolometer arrays
- Wide-angle bolometers

Fluctuations/wave activities

- Microwave scattering
- X-mode microwave reflectometer
- Beam emission spectroscopy
- X-Ray imaging system
- ECE grating polychromator
- Neutron fluctuation detector
- Mirnov coils
- ICE/RF probes

Plasma edge/wall

- Plasma TV
 - IR camera
 - Filtered diodes (C-II)
 - Filtered diodes (H-alpha)
 - Sample exposure probe
 - Disruption monitor (IR detector)
 - Fabry-Perot (H/D/T ratios)
-

Note: The broad array of diagnostics is necessary for a large tokamak (TFTR); a few additions (e.g., for a device with a divertor plasma region) or deletions (e.g., for a device not carrying out alpha-physics studies) are device-specific.

Proponents' and Critics' Claims

Plasma diagnostics instruments are essential elements of any experimental plasma physics and are applied to many devices. They are designed specifically for the device on which they are applied. There are no universal critics of plasma diagnostics, but rather critics of the devices on which the diagnostics are deployed, or of the number and cost of a set of diagnostics, or of the performance and interpretation of a specific diagnostic.

A serious issue for plasma diagnostics has been the steady erosion of direct funding of new diagnostic concept development over the last 10 or so years; most diagnostic funding is now provided through the funding of the device on which the instrument is applied. A new diagnostic is often costly and tardy because the concepts have not been sufficiently demonstrated.

Description

Future inertial fusion energy (IFE) diagnostics will be built on our current experience with inertial confinement fusion (ICF) experiments. The diagnosis must include successful as well as unsuccessful high neutron yield implosions. The requisite diagnostics will comprise a large array of neutron and charged-particle diagnostics covering a wide range of yields with and without imaging capability and with and without temporal resolution. These diagnostics must be augmented by a vast array of spectroscopic diagnostics ranging from the hard X-ray region to the red end of the visible spectrum for the purpose of gathering critical target physics data and characterizing IFE drive conditions. In addition, the diagnostics must cover the accurate diagnosis of the target prior to irradiation. This is particularly important because of the added complexities arising from the cryogenic fuel conditions required for most current IFE target designs. In all cases involving laser drivers, the diagnostic complement has to include very precise laser diagnostics for beam energies, pulse shapes, and intensity distributions inside the hohlraum plasma or the direct-drive corona.

Status

The current target and drive diagnostics have been primarily developed and refined on the NOVA, OMEGA, and NIKE laser systems over the past two decades. They are an excellent starting point for the future IFE diagnostics, but most of them will require significant further development. Most of the X-ray drive diagnostics for the indirect-drive approach are close to future requirements as are the basic (time-integrated) neutron yield diagnostics. However, (time-resolved) burn history diagnostics or core imaging diagnostics (neutron imaging, hard X-ray imaging, and charged-particle imaging) all need considerably further scientific and technological development. Core mix diagnostics will be essential for verifying the core assembly and deleterious effects of hydrodynamic instabilities. These diagnostics are likely to involve spectroscopy techniques that are not well developed, particularly the theoretical underpinning of these diagnostics. Charged-particle diagnostics are being developed and refined at this point. They will require further development for future IFE applications. The preirradiation cryogenic target diagnostics are presently clearly insufficient for future applications, and significant scientific and technological development is required.

Current Research and Development (R&D)**R&D Goals and Challenges**

- **Implosion diagnostics:** The goals of many target diagnostics are effective diagnoses of successful *and* unsuccessful implosions. The definition of these diagnostics requires extensive integrated hydrodynamic simulations with appropriate diagnostic packages. Thus, IFE target design and implosion diagnostics become interdependent, and the development of one may be a prerequisite for the other. Therefore, the challenge is the successful integration of the target design with the diagnostic design and development. For example, neutron imaging of a successful ignition experiment may require less spatial resolution than the diagnosis of an unsuccessful ignition experiment. Since we will very likely proceed from unsuccessful experiments to successful ones, the diagnostics must be based on appropriate hydrodynamic simulations. Similar conclusions have been drawn from simulated hard X-ray images, which are complementary to neutron imaging.
- **Drive uniformity:** The drive uniformity requirements for direct-drive and indirect-drive IFE are significantly different, but either approach challenges the present diagnostic capabilities. For indirect drive, the accurate time-dependent assessment of low-order $Y_{\ell m}$ -mode drive distortions presents a significant challenge, while the direct-drive approach requires improved understanding and mitigation of laser imprinting and mitigation of the Rayleigh-Taylor instability. These diagnostic problems include physics issues as well as diagnostics issues.
- **Target diagnostics:** Current cryogenic target designs raise significant diagnostic challenges such as the characterization of the deuterium-tritium (D-T) ice layer inside opaque target shells, which may possibly be surrounded by complex hohlraum structures. The goals are micron or sub-micron accuracy in the determination of these ice layers with additional detailed information on the spatial frequency distribution of any ice layer imperfections.

Related R&D Activities

Implosion diagnostics are being developed and refined at Lawrence Livermore National Laboratory (LLNL), DIF-CEA (France), LLE, the Naval Research Laboratory (NRL), and elsewhere. Theoretical support comes from the same laboratories as well as the Universities of Wisconsin, Maryland, Florida, and others. There is a collaborative effort under way between the various laboratories to develop the specifications for the diagnostics as well as the diagnostics themselves. Similarly, diagnostic checkout and testing is spread out over many laboratories to optimize the conditions for the checkout.

Recent Successes

Recent successes include the extensive drive symmetry campaigns carried out by LLNL on the OMEGA laser facility where the laser drive conditions could be tailored to effectively simulate National Ignition Facility (NIF) conditions. The diagnostic refinements in these experiments will certainly carry over to future drive symmetry diagnostics. Similarly, the Massachusetts Institute of Technology (MIT) charged-particle spectrometers fielded on OMEGA have yielded a vast amount of information within <1 year of implementation. These data included density, p_r , symmetry, yield, and T_i measurements among other results. Similarly, many direct-drive and indirect-drive Rayleigh-Taylor instability experiments have been investigated with an impressive array of diagnostics that will carry over to future IFE facilities.

Anticipated Contributions Relative to Metrics

Metrics

- Target core diagnostics: Neutron yields— 10^7 to 10^{20} at $\rho r \leq 1 \text{ g/cm}^2$ and $\rho \leq 1 \text{ kg/cm}^3$; burn history—50-psec resolution; core imaging— $\leq 5 \text{ }\mu\text{m}$ for 14-MeV neutrons and 10-keV X rays.
- Drive diagnostics: Indirect drive— $Y_{\ell m}$ nonuniformity $\sim 1\%$ for $\ell = 2$, $\ll 1\%$ for higher ℓ -modes; direct drive—improved imprinting diagnostics for ℓ -modes between 50 and 200.
- Target diagnostics: Surface characterization including ℓ -mode spectra with $\sigma_{\text{rms}} \leq 200 \text{ }\mu\text{m}$, ice layers with $\sigma_{\text{rms}} \leq 1 \text{ }\mu\text{m}$; drive power balance—8% rms for indirect drive, $\sim 1\%$ for direct drive.

Near Term ≤ 5 years

- Target core diagnostics: Neutron yield measurements do not present a problem. OMEGA will demonstrate $\rho \leq 200 \text{ g/cm}^3$ and $\rho r \leq 300 \text{ mg/cm}^2$ using various reaction products and diagnostics. Present burn history measurements have the requisite resolution, but extension to future IFE machines requires new approaches. Preliminary development will identify appropriate approaches during this time, including initial testing on OMEGA. Core imaging with 14-MeV neutrons may reach 15–20 μm resolution during this time, using simple extension of existing technology. New approaches will have to be identified during this period. X-ray imaging tests in the 10-keV region will be carried out during this time.
- Drive diagnostics: Indirect drive—appropriate diagnostics for ℓ -mode for $\ell \leq 8$ will be developed and tested on OMEGA. Direct drive—OMEGA and NIKE experiments will determine diagnostics and permissible laser imprint levels during this time.
- Target diagnostics: Outer surface characterization will probably not pose a problem for IFE targets. Inner ice layer characterization will be carried out during this time at various laboratories [LLNL, Los Alamos National Laboratory (LANL), and LLE]. Optimization methods will be developed. Full ℓ -mode characterization of the inner ice layer may not be fully developed during this time.

Midterm ~ 20 years

- Target core diagnostics: Full diagnostic capability for $\rho r \leq 1 \text{ g/cm}^2$ and $\rho \leq 1 \text{ kg/cm}^3$ will be available within this time frame. We can expect to have burn history measurements free of neutron dispersion effects (e.g., primary γ -ray measurements) at this time.
- Drive diagnostics: The present difficulties with drive uniformity should not extend beyond the 15-year horizon.
- Target diagnostics: Target characterization may be an ongoing effort, which may have to change and adapt as new target designs are developed.

Long Term >20 years

One would not expect basic target diagnostics to be a major concern in this time frame. However, target development and target designs will continue to evolve and will likely continue to require further diagnostic development and technological advances.

Proponents' and Critics' Claims

Proponents claim that the diagnostics required for IFE will basically be fully developed by ~ 2020 . The open problems will include drivers and target designs, target fabrication, and their budgetary implications. These issues will continue to have some diagnostic implications, but most likely these will be of the incremental kind.

Critics point out that the fine tuning of the IFE target implosions is difficult to achieve with the kind of diagnostics that have been developed so far and that appear to be likely candidates for the future. The final (under-performing) implosion product does not easily allow an unraveling in terms of identifiable culprits, whether they are hidden in the drive, the target, or possibly in the laser-plasma interaction processes. Thus, new and hitherto untried or unimagined diagnostics may be required to obtain the required target performance.

Description

The vision for the Fusion Scientific Simulation Initiative (SSI) is to catalyze a dramatic change in the way research is presently carried out by enabling the accelerated development of computational tools and techniques that would revolutionize the understanding and design of a fusion energy source. This is made possible by the exciting advances in high-performance computing, which will allow simulations of more complex phenomena with higher fidelity.

Status

Building upon a prominent history of advanced computation, which can be traced back to the establishment of the predecessor to the National Energy Research Scientific Computing Center (NERSC) nearly 25 years ago, the U.S. fusion community has been rewarded by impressive advances in the simulation and modeling of plasma confinement and the interactions of plasma with its surroundings. This has led to major progress in the modeling of turbulence-driven energy transport, macroscopic dynamics of magnetically confined plasmas, heat and particle exhaust across the plasma edge, and major improvements in the simulations of device components such as space-charge-dominated beams for inertial fusion energy (IFE) drivers.

Current Research and Development (R&D)**R&D Goals and Challenges**

The scientific goal of fusion SSI is to utilize advanced computing, in tandem with theory and experiment, to extract key physics insights and guide current experiments, to design innovative new devices, and to leverage large-scale international facilities. A successful SSI will contribute greatly to the U.S. ability to retain its intellectual leadership in the world fusion program by seizing the opportunity to accelerate the development of realistic simulations of fusion systems. A greatly enhanced computational effort, benchmarked against the best experimental results from national and international experiments, will help provide the scientific and technical foundations needed for key decisions on major new facilities for fusion research.

Although the fundamental laws that determine the behavior of fusion plasmas are well known, such as Maxwell's equations and those of classical statistical mechanics, obtaining their solution under realistic conditions is a scientific problem of extraordinary complexity. This is due in large part to the fact that there is an enormous range of temporal and spatial scales involved in fusion plasmas. The relevant physical processes can span over 10 decades in time and space. Effective prediction of the properties of energy-producing fusion plasma systems depends on the successful integration of many complex phenomena spanning these vast ranges. This is a formidable challenge that can only be met with advanced scientific computing in tandem with theory and experiment.

Related R&D Activities

An accelerated simulation initiative in fusion energy sciences would also stimulate scientific alliances with other application areas in the Department of Energy (DOE) Office of Science portfolio and increase collaboration with Advanced Strategic Computing Initiative (ASCI). Effective modeling of global systems, combustion, and fusion devices all deal with complex, three-dimensional (3-D), nonlinear fluid flows and associated kinetic dynamics, albeit in very different parametric regimes. They share the common computational challenge to rapidly develop advanced integrated modeling capabilities that can treat complex dynamical systems covering many decades in time and space. Some research collaborations already exist between plasma science and ASCI programs, since the physics and mathematical challenges are similar. For example, the computational challenges posed by nonlinear plasma fluid problems share many common features with computational fluid dynamics (CFD) issues faced in ASCI, Global Systems and Combustion Modeling, Materials Sciences, and numerous other areas. As for non-DOE agencies, plasma physics has long-standing programs with the National Aeronautics and Space Administration (NASA) and the National Science Foundation (NSF) in the space physics and basic science arenas, which now could be further strengthened. Additionally, advanced computational modeling capabilities will also stimulate progress in nonfusion plasma applications, including the manufacture of microelectronic components, plasma display panels, plasma thrusters for satellites, and plasmas for waste remediation. Realistic physics-based plasma models will also help accelerate the pace of breakthroughs in plasma science applications to energetic beams, space physics, solar physics, and astrophysics.

Recent Successes

Some examples of recent successes include simulations of (1) large-scale disruptions in a fusion-energy-producing toroidal plasma [Fig. 1(a)], (2) turbulence suppression with self-generated flows in localized regions of the plasma [Fig. 1(b)], and (3) 3-D modeling of heavy ion accelerators [Fig. 1(c)].

Metrics

The scientific foundations for the fusion SSI are very strong, and the accelerated development of a realistic predictive simulation capability for both magnetic fusion energy (MFE) and IFE is now enabled by the availability of state-of-the-art high-performance computing platforms. There are two strategic elements in this initiative: direct numerical simulation (DNS) and integrated modeling (IM). Accelerating the development of the best DNS models will require increasing both the sophistication of the mathematical physics formulation and their resolution. These models fall into two categories: those addressing the microscopic scales that determine plasma transport and those addressing the macroscopic scales associated with rapid large-scale plasma instabilities. As new computing resources allow each category to extend both simulation domains and the incorporation of more detailed physical effects, there should be overlapping regions of validity. Moreover, the more complex plasma systems simulated may be not only more complicated, but the components could be found to interact in ways that produce new, often unexpected, effects. The defining feature of the second strategic element, IM, is the commitment to simulate an entire experimental device over macroscopic time scales. All relevant physical processes will be represented at some level by interconnected modules. The new resources made available by the SSI for DNS models will enable more effective development of physics-based reduced models that are acceptably realistic and accurate. Hence, the SSI resources would enable IM at a level of realism and complexity much greater than is presently possible either in MFE or IFE research.

Roadmap

The implementation of the fusion SSI program could be cast in three stages, which are related to the availability of progressively more powerful high-performance computing platforms. Critical scientific issues can be addressed by 0.5-, 5-, and 50-teraflop computers and the corresponding increase in memory and data-handling capacity. A sample roadmap for first-principles simulations of plasma microturbulence is shown in Fig. 2.

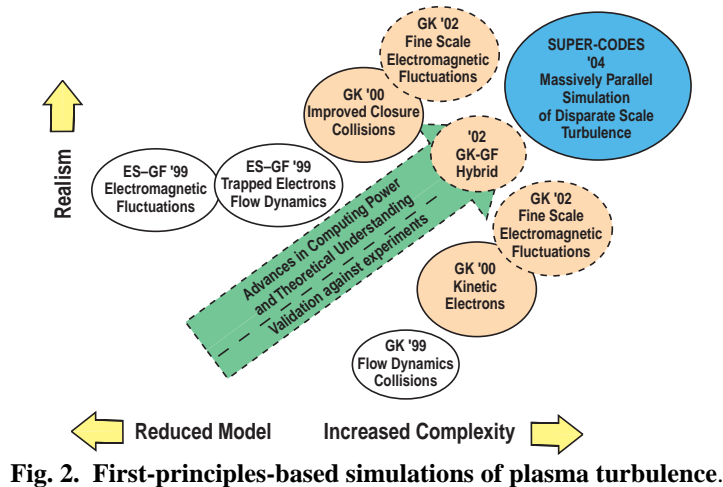

Fig. 2. First-principles-based simulations of plasma turbulence.

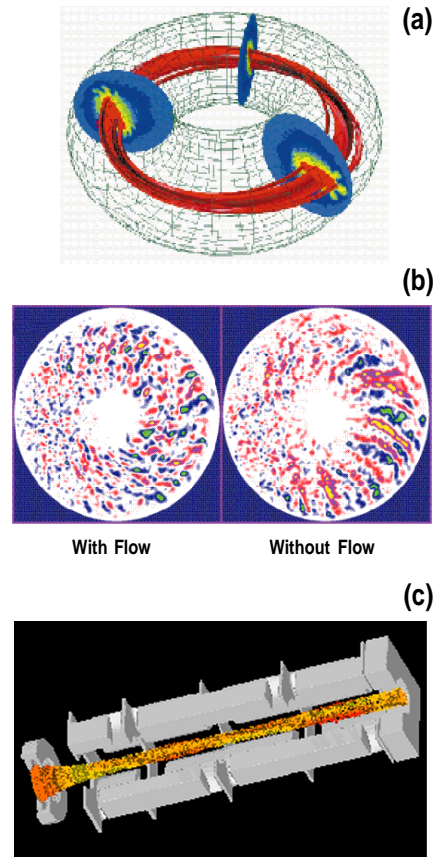

Fig. 1. (a) Simulation of high plasma pressure-induced disruption in the Tokamak Fusion Test Reactor. (b) Turbulence reduction via sheared plasma flow (right), compared to case with flow suppressed (left). Results obtained using full MPP capabilities of CRAY T3E Supercomputer at NERSC [Source: Z. Lin et al., *Science* 281, 1835 (1998)]. (c) A particle-in-cell simulation used to design a prototype “electrostatic-quadruple” heavy-ion beam injector at Lawrence Berkeley National Laboratory. The color of each simulation particle denotes the local potential, relative to the on-axis value.

Description

Computational modeling of the plasma and auxiliary systems has been an important component of both the magnetic fusion energy (MFE) and inertial confinement fusion (ICF) programs since at least the early 1970s. These codes integrate the plasma physics with external sources and are used to interpret and predict macroscopic plasma behavior. Present MFE transport simulation codes couple two-dimensional (2-D) magnetohydrodynamic (MHD) equilibria with fluid transport equations for particles, momentum, and energy. In ICF, simulations are usually performed with one-dimensional (1-D) and/or multidimensional hydrodynamic codes that incorporate the physics relevant to the processes important to the target design being investigated. In both MFE and ICF, the physics is incorporated in “modules or algorithms” using the best physics understanding to date, which can be supported by current computer systems.

Status

In MFE several fluid transport codes are in wide use, but they differ in the component physics they emphasize and, therefore, in the types of applications they address. Interpretive codes make maximum use of experimental data to deduce confinement properties, while predictive codes make maximum use of models for experimental validation and design of new experiments. Core codes emphasize the closed field line region of the plasma using 1-D transport equations, while edge codes model the open field line region between the core and bounding material surfaces with 2-D equations. The simulation codes presently in use for ICF are 1- and 2-D hydrodynamic codes funded predominately by the Department of Energy (DOE)–Defense Programs (DP). Presently, advanced 2- and 3-D code development is being funded by the DOE–DP Advanced Strategic Computing Initiative (ASCI) Program and to a much lesser extent the DOE–DP ICF Program. The existing 1- and 2-D hydrodynamics codes used for ICF research have been heavily checked and validated against experimental data obtained on existing ICF facilities.

Current Research and Development (R&D)**R&D Goals and Challenges**

- The primary goal of the MFE program is to develop a comprehensive, integrated set of codes that integrate the component physics, auxiliary sources, and interaction with the bounding walls, and provide a quantitative assessment of the viability of the confinement concept as a fusion energy source.
- As part of the DOE–DP ASCI Program, new 3-D ICF codes will be developed. Of particular importance will be software development required for efficient use of massively parallel machines. This applies to both “user”-written code algorithms as well as “vendor”-supplied operating systems, compilers, debuggers, and visualization/analysis software. The actual performance of the new ASCI machines also represents a significant R&D challenge both for the vendors as well as the end users.
- A significant goal associated with advanced hydrodynamic code development for ICF and inertial fusion energy (IFE) will be designing and conducting relevant experiments that verify the algorithms implemented in these codes and validate the overall integrated predictive capabilities of the codes. This verification and validation will be essential in order to have confidence for predictions of targets being designed for IFE reactor facilities.

Related R&D Activities

- Cooperate with the international MFE experiments in development, testing, and validation of codes and component models.
- Coordinate with the code development being carried out under the DOE–DP ASCI Program.
- Coordinate with existing DOE–DP activities planning and conducting experiments on high energy density (HED) facilities such as the National Ignition Facility (NIF).

Recent Successes

- MFE core physics codes, coordinated with codes that model the microscopic behavior of plasma turbulence, have helped identify the role that sheared flow plays in reducing transport and improving confinement.
- The MFE edge physics codes have matured significantly in recent years to the point that they can reproduce many aspects of experimental observation.
- The DOE–DP programs have had significant successes in developing 2-D hydrodynamics codes for use in HED research. These codes have been extensively verified and validated (V&V) against relevant experimental data. In particular the Lasnex code played an integral role in the national ICF program’s ability to successfully complete the Nova Technical Contract (NTC). The NTC was an essential step in the decision to go forward with the design and construction of the NIF.
- Modern 3-D hydrodynamic codes have been developed as part of the DOE–DP ASCI Program. These codes are beginning to be used in research associated with designing capsules to achieve ignition on the NIF as well as the design and analysis of HED experiments.

Budget

- DOE–OFES: FY 1999 = ~\$9M (~\$0.5M for target design).
 - DOE–DP-ICF: FY 1999 = ~\$500M including NIF construction (~\$7–10M for target physics-/design-related activities).
-

Anticipated Contributions Relative to Metrics

Metrics

- Develop a quantitative modeling capability of confinement in MFE plasmas that includes a comprehensive treatment of the geometry, field structure, and interaction with the bounding surfaces and external systems.
- Identify target designs coupled with reactor systems that meet the requirements for the competitive cost of electricity for commercial power. This will require increased experimental data in a number of critical areas as well as integrated multidimensional design simulations. This experimental data will be used to validate and verify existing and new codes.

Near Term <5 years

- Improved core transport models that are derived from or linked to comprehensive microscopic models of plasma turbulence in magnetically confined plasmas.
- Improved 2- and 3-D hydrodynamic codes will become available. These new codes will not be fully validated against experimental data and “benchmark” simulation results. This process will continue beyond the 5-year period. These codes will be funded entirely by the DOE–DP ASCI.

Midterm 5–20 years

- Combined treatment of the core and edge of magnetically confined plasmas for consistent treatment of the physics in all regions.
- Transport coupled with 3-D MHD equilibria to facilitate the comparison of axisymmetric and non-axisymmetric plasmas.
- Use of mature and validated 3-D codes for IFE target designs.

Long Term >20 years

- Use of the predictive capabilities of the transport modeling codes to aid in the selection and design of MFE and IFE power plants.

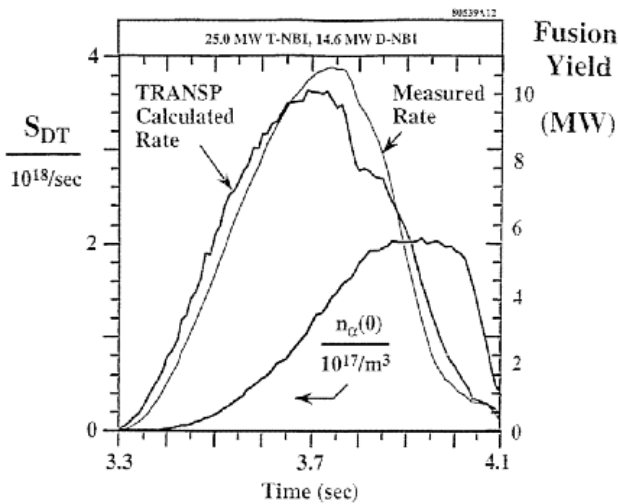

Time evolution of the fusion power, the TRANSP calculation of the fusion power, and the TRANSP calculation of the central alpha density for the TFTR plasmas that had the highest fusion power.

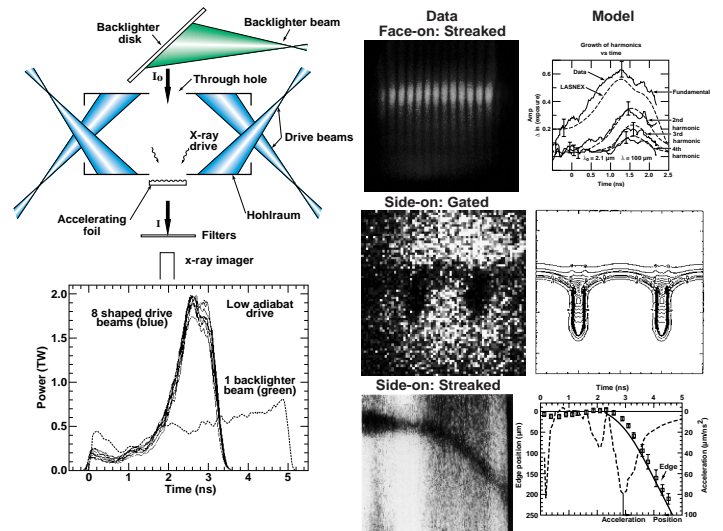

The measured growth of planar hydrodynamic instabilities in ICF is in quantitative agreement with numerical models.

Proponents' and Critics' Claims

Proponents claim that transport modeling codes have played a crucial role in interpreting and predicting plasma behavior even though many aspects of the component models are heuristic or empirical. Proponent's point to the clear success of the DOE–DP with respect to the development and use of multidimensional simulation codes. This methodology of integrated use of experimental data and simulations has served as a model for other programs to follow.

Critics claim that the turbulent transport processes and their interaction with MHD effects are so complex and exhibit such a wide range of spatial and temporal scales in magnetically confined plasmas that transport codes will never be able to capture all of the macroscopic aspects of their behavior from first principles.

S-17. ASTROPHYSICS USING FUSION FACILITIES

Description

Astrophysical models are routinely tested against observational results rather than against experiments with controlled initial conditions. Creating a surrogate astrophysical environment in the laboratory has heretofore been impossible because of the high energy density required. Fusion facilities offer the capability to perform controlled experiments in a realm of plasma temperatures and densities that approach astrophysical regimes in several important parameters; the physics of the problems studied may be scaled over many orders of magnitude in spatial scale. Examples include strong shocks in ionized media; high Mach number supersonic jets; material flow in strongly coupled, Fermi degenerate matter; hydrodynamic instabilities in hot, compressible matter with low viscosity; radiation transport dominated by X rays; photoevaporation front, coupled radiative hydrodynamics; and material properties such as equations of state at high pressure.

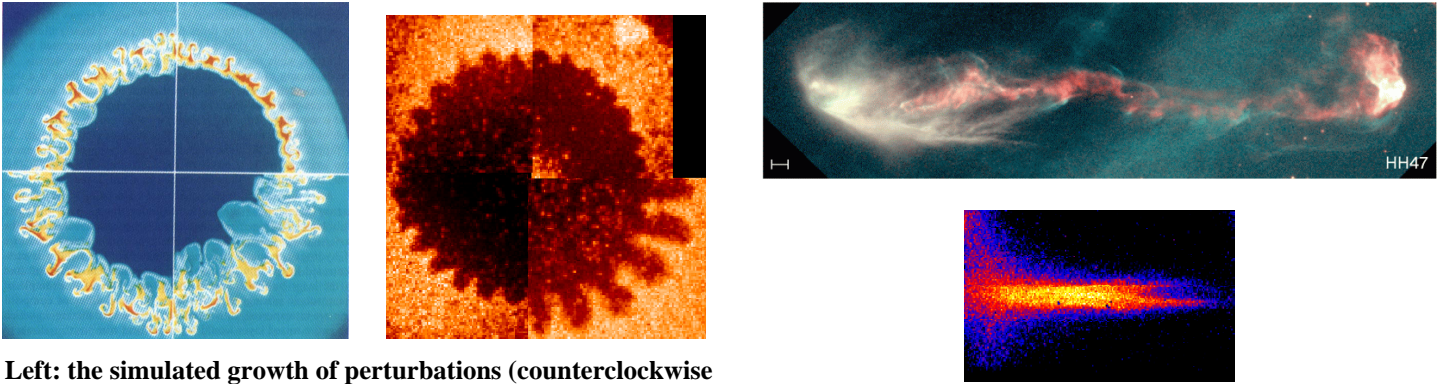

Left: the simulated growth of perturbations (counterclockwise through four time periods) in the outer regions of supernova SN1987a. Right: Experimental radiographs from the Nova laser showing remarkable supernova-like mixing features.

Top: the Herbig-Hero object HH47, a galactic radiative jet in interstellar space. Bottom: Experimental radiating jet formed by colliding plasmas on the Nova laser.

Status

Experiments have been performed on the Nova [United States, Lawrence Livermore National Laboratory (LLNL)] and Gekko (Japan, ILE) lasers and reported extensively in the literature. Current experiments are also under way on the Omega [United States, Laboratory for Laser Energetics (LLE)] laser. The Center for Astrophysics with Intense Lasers at LLNL has sponsored two international workshops, the second attended by 130 participants from 13 countries. Of the 112 contributed papers, 40 were by astrophysicists.

Current Research and Development (R&D)

Experiments on the Nova, Omega, and Gekko lasers have concentrated on hydrodynamics studies (of turbulence, mixing, material flow, and supersonic jets); material properties at high pressure; and opacity of ionized elements.

R&D Goals and Challenges

Measuring compressible turbulent mixing structures requires great precision to validate astrophysical models. Current techniques are barely adequate, and refinements in simulations will require improvements in imaging techniques. Extending hydrodynamics experiments to the many-layer systems inferred in supernovae will require material density changes of orders of magnitude in one target. This is achieved through the extensive use of low-density foams in laser targets and will continue to require research in foam chemistry.

Related R&D Activities

While these experiments have been conducted on laser facilities to date, other fusion facilities such as Sandia's Z Facility would be suitable for creating the plasma conditions found in astrophysical systems.

Budget

\$1M from the Department of Energy–Defense Programs (DOE–DP) supports research at several universities and national laboratories.

Anticipated Contributions Relative to Metrics

Metrics

Laboratory astrophysics experiments on fusion facilities can have a significant impact on physics models used to understand astrophysical phenomena. The following is a list of measurements of interest:

- Laboratory results on three-dimensional (3-D) strong-shock-induced mixing relevant to supernovae.
- Radiative hydrodynamics in both shocks (relevant to supernovae) and jets (relevant to high Mach number astrophysical jets).
- Relativistic plasmas with significant components of matter-antimatter pairs, using ultrahigh-intensity laser facilities.
- Opacities in low-density systems relevant to supernova light curves and stellar atmospheres.
- Equations of state under extreme pressures existing in the interiors of giant planets and brown dwarfs.
- Thermonuclear burn wave propagation and dynamics relevant to supernovae and X-ray bursters.

Near Term <5 years

Experimental campaigns will continue on large laser facilities. Experiments have been approved for the Omega laser in FY 1999 and begun on the Gekko laser. Planning for experiments on the National Ignition Facility (NIF) laser will begin.

Midterm ~20 years

The NIF laser will open new regimes for laboratory astrophysics experiments and allow the completion of many of the tasks listed above. The laser experiments to date are still in their infancy and have largely been proof-of-principle demonstrations. On NIF, this astrophysics work will reach full maturity, with critical astrophysics questions posed and definitive experimental answers obtained. Questions such as the role of radiative cooling in astrophysical shocks and jets, and 3-D deep nonlinear mixing in multilayer, spherical systems will no longer reside purely in the realm of computer simulations, but will be addressed with well-posed, rigorously scaled experiments as well. The development of intense lasers and, in particular, the NIF offers an unprecedented opportunity to develop scaled reproductions of dynamically evolving, high-energy-density astrophysical systems in the laboratory. The potential for the advancement of astrophysical understanding with careful use of this new tool, NIF, is now recognized in the astrophysics community.

Proponents' and Critics' Claims

Proponents think that there has been real progress in this area, with direct connections between the laboratory and astrophysical systems already established. In the areas of equation of state and opacity, laboratory experiments have provided improved knowledge of material properties that impact our understanding of giant planets and pulsating stars. In the areas of hydrodynamics, experiments are producing phenomena such as compressible turbulent mixing, flow-driven strong shocks, and material flow in the solid state, which are relevant to supernovae, supernova remnants, and planetary interiors. The strong collaborative nature of this research with academia is of great benefit to the long-range DOE stewardship effort, with the best minds in the country being tapped on scientific problems of generic interest to DOE. The extensive university involvement seeds new talent to enter the DOE labs in the future, trained in the fundamental technical areas of concern, but pursued in the open setting of astrophysics research.

Critics have claimed that the physics of astronomical systems does not scale to laboratory spatial scales. Although this is true in some instances, it is by no means a universal truth. A large number of astrophysical problems are in a regime in which viscosity and radiative effects are negligible and the dominant physics is "pure" hydrodynamics; such systems follow simple Euler scaling. Radiative effects in hydrodynamics can also be addressed in properly scaled conditions in many circumstances, with dimensionless cooling lengths and Mach numbers characterizing the result. Another criticism has been that DOE funding should be focused exclusively on DOE issues, classified or otherwise, and that the more academic flavor of astrophysics research is just a diversion. However, a deep understanding of issues such as scaling resides at the very core of the stewardship mission. This rigorous scaling is also one of the fundamental issues of laser-based astrophysics. The match of science-based stewardship and laboratory astrophysics is exceedingly synergistic.

C.6 NEAR-TERM COMMERCIAL APPLICATIONS

The practical applications of plasmas and associated technologies are of growing importance to the government and national economy. Chemical engineers have long recognized the utility of plasmas in performing “high-temperature” chemistry at low temperatures. Fusion energy R&D has resulted in better understanding of plasma processes and in the ability to manipulate plasmas for many purposes. The technologies, theoretical models, and computational tools developed in the fusion program are being used in a variety of market segments including electronics, manufacturing, health care, environmental protection, aerospace, and textiles. Most of the institutions participating in the fusion energy sciences program are investigating near-term applications. This programmatic mixture has led to an effective transfer out of and into the fusion program. There are several high-impact opportunities for applying the plasma expertise developed within the fusion research program to near-term industrial and government needs. These opportunities provide high visibility to the fusion program based on the interest of the public, Congress, and the media in new technological “spin-offs.” They also enable “spin-on” of new technologies into the fusion program from other communities. In virtually all applications, an interdisciplinary approach is required; plasma science must be integrated with chemistry, atomic physics, surface and materials science, thermodynamics, mechanical engineering, and economics. Some processes, such as the thermochemical heat treatment of metals, the activation of polymers, thermal spraying of ceramic coatings, and etching of semiconductors, are well-established in industry, while others belong to new and emerging technologies, such as plasma immersion ion implantation and intense ion beam processing.

OFES and the NSF are major government sponsors of plasma R&D. The NSF has funded near-term application programs. In addition to sponsoring many single-investigator led projects, the NSF supports three Engineering Research Centers on (1) Advanced Electronic Materials Processing at North Carolina State University (\$28.6M between 1988 and 2000—plasma processing is one of five thrusts); (2) Plasma Aided Manufacturing at the University of Wisconsin (\$25.7M between 1988 and 1998); and (3) Environmentally Benign Semiconductor Manufacturing at the University of Arizona (\$3.1M between 1996 and 2001—plasma processing is one of six thrusts).

The following two-pagers discuss applications of plasma science and technology to these areas:

- Semiconductors
- Advanced Materials Processing and Manufacturing
- Environment
- Medical Applications
- Plasma Propulsion

Description

The practical application of plasmas and associated technologies in industry are of growing importance to the national economy. The semiconductor industry employs many technologies originally developed for or similar to those used in fusion research. Plasma processing is one “spin-off” example, but others include diagnostics, modeling, metrology, magnets, radio frequency (rf), microwave, neutral beam, electron beam, ion beam, and laser sources. Involvement with the semiconductor industry fits into OFE’s role as one of the stewardship agencies for Plasma Science and Technology.

Status

Chip-making technologies that use plasmas and associated technologies are identified in Fig. 1. The wafer patterning lithography and plasma processing market is approximately \$8B/year.

About 10 years ago, the attention of policy makers and Congress became focused on U.S. competitiveness in the world market place. A theme emerged that the “jewels of government-funded research” should be made available to U.S. industry, and it was correctly noticed that in comparison with Europe or Japan, U.S. research activities in the Department of Energy (DOE) national laboratories were quite insulated from the industrial research community and its interests. Cooperative Research and Development Agreements (CRADAs) and work for others (WFO) arrangements were initiated to encourage stronger coupling between government-sponsored research and industrial needs. Recent legislation has reduced some of the barriers (i.e., DOE added factor) that have limited interactions. DOE funds for CRADAs have been reduced in recent years, and thus, most new work at national laboratories has been funded up to 100% by industry through CRADAs or WFOs. Many of these projects have been very successful and illustrate clearly the overlap of laboratory and university expertise with industry needs. Some important examples are multilaboratory CRADAs and WFOs with SEMATECH and Intel. One drawback is that direct industry funding tends to lead to projects with very short term and limited goals and has sometimes led to conflicts over ownership of intellectual property. Funding for research that extends basic science and technology work to areas that are industrially relevant (medium and long term) is quite limited.

Within the university community, the 1998 phase-out of the National Science Foundation (NSF) Center for Plasma-Aided Manufacturing at the University of Wisconsin in Madison, after 11 years of successful operation, has put stress on funding of basic plasma science and engineering for materials processing. This has been somewhat compensated for by the recent NSF/DOE Plasma Science Initiative, made available in 1997–98. This produced additional DOE funds to support basic research in plasma science and engineering. Such long-term sources of funding are vital for this area because industrial funding is typically short term (one year or less) and often involves graduate students in proprietary research with publication restrictions. On the private side, PMT and ASTEX are examples of successful companies that were founded by members of the plasma physics community.

Current Research and Development (R&D)

R&D Goals and Challenges

Several DOE laboratories and many university centers have ongoing work with the semiconductor industry as discussed under the near-term program. While much of the work involves the use of plasmas, many processes only involve the use of fusion technologies (i.e., diagnostics, rf and microwaves, beam and laser sources, models, and algorithms).

Related R&D Activities

- Individual U.S. industry R&D and consortia such as SEMATECH, SRC, SEMI, and MARCO provide funds to national laboratories and universities. DARPA and NSF supported some limited research. Plasma science work related to semiconductors is generally reported at the Gaseous Electronics Conference, American Vacuum Society, Institute of Electrical and Electronic Engineers Plasma Science, and the American Physical Science DPS meetings.
- International programs in Asia and Europe coordinate industry- and government-sponsored semiconductor research that includes extensive work in plasma processing.

Recent Successes

- Plasma sources are used in 25–30% of the steps required to process a wafer from bare silicon to a finished wafer.
- Plasma physics control of n and Δn developed from diagnostic measurements, modeling, and improvements to rf and microwave systems enhances the throughput and yield of these systems.
- Atomic physics databases have been extended to include plasma chemistries important to the plasma process modeling community.
- Plasma ionization and collision databases have been extended to include plasma chemistries important to the plasma process modeling community.
- Plasma damage of device structures has emerged as a major impact on wafer yield. Models of plasma damage mechanisms have been developed and experimentally tested.
- New plasma sources have been developed that extend process ranges, allowing the etching of wafer features as small as 0.1 μm .
- Plasma-Enhanced Chemical Vapor Deposition (PECVD) is used to create new materials and to deposit the “seed” layers inside small narrow features prior to other film deposition steps.
- Plasmas for several wafer doping processes include high-energy ion implant, low-energy shallow trench, and silicon-on-insulator.
- Diagnostic and rf sensors and control algorithms modified from fusion experiments have been used to control plasma processing equipment.
- Plasma sources and fusion-related plasmas technologies are required for next-generation nonoptical lithographic systems (E-beam, X-ray, EUV).
- Diagnostic techniques developed for fusion experiments have been extended for use in imaging wafer features.
- Plasma discharges are used in many of the large flat panel displays currently on the market.
- Plasma discharges are used to treat the vacuum exhaust components from process chambers converting toxic or global warming gases into benign by-products.

Budget

There is currently no direct DOE–OFES funding in this area. A small amount of funding that can bridge the gap between basic and applied R&D may have a significant impact.

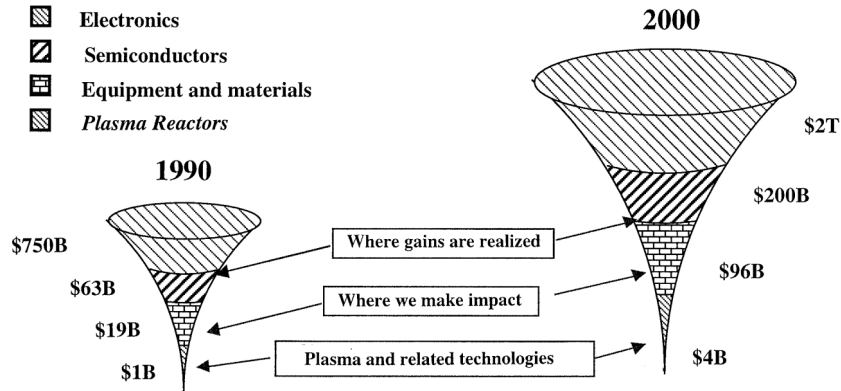

Fig. 1. Chip-making technologies.

Anticipated Contributions Relative to Metrics

Metrics

OFES and NSF are the stewardship agencies for Plasma Science and Technology. There are numerous advantages to be derived from applying the plasma expertise developed within the fusion research program to nearer term industrial and other government needs. It allows fusion scientists and engineers to contribute high-impact solutions to major industry sectors including semiconductor manufacturing. It provides high visibility to the fusion program based on the interest of the public, Congress, and the media in new technological spin-offs. It increases the spin-in of new technology into the fusion program from applied sectors of the scientific and industrial community. A roadmap exists for the semiconductor industry, and it contains goals for plasma processing performance.

Near Term <5 to 10 years

Several DOE laboratories and many university centers have ongoing work with the semiconductor industry.

- Plasma sources for plasma chemistry required for semiconductor etch and deposition.
- Plasma charging of wafer surfaces and damage to transistor and capacitive structures.
- Plasma discharges for plasma displays.
- Plasma, rf, and microwave control algorithms for process stability and power control.
- Plasma, rf, and optical diagnostics for process sensors, wafer metrology, and defect detection.
- Plasma and rf modeling science of plasma sources, rf antennas, laser deposition, and nonlinear phenomena.
- Ion, electron, neutral, and laser beams for electron-beam (E-beam) lithography, surface and bulk material modifications, process waste treatment, X-ray, and EUV lithography.

Improve plasma processing equipment through experimental measurements and modeling. Expand the use of fusion-related technologies in the semiconductor industry. Establish a National Plasma Technology Advisory Committee to help identify appropriate technological needs and connect researchers with each other and with appropriate industrial companies.

Midterm 10–20 years

Develop models that can include plasma properties and plasma chemistry along with feature scale effects at the wafer surface. Utilize Plasma Science and Technology to extend beyond the current manufacturing and measurement capabilities of the semiconductor industry.

Science

Establish a knowledge base and a fundamental understanding of key phenomena in plasma processing for semiconductors. Develop models of plasma processing that include the important chemical species, power balances, wall interactions, plasma boundary effects, and “feature scale” effects on the wafer surface. Develop fundamentally new lithographic techniques that can replace optical lithography. Understand “plasma damage” mechanisms to limit damage to chip devices.

Proponents’ and Critics’ Claims

Proponents claim that science and technology developed for fusion have been under used by the semiconductor processing community, that both spin-offs and spin-ins will benefit the fusion community, that industry-funded research helps maintain a critical mass of expertise, and that industry cannot maintain large staffs of plasma experts and, thus, can cost-effectively draw on expertise in the fusion community.

Critics claim that coordinated research between industry and government is “corporate welfare,” that university and national laboratory research is disconnected from industry needs, that national laboratory research is too expensive for industry, and that government “terms and conditions” and bureaucracy can be a barrier to industry.

Description

The last decade has witnessed a remarkable growth in the application of plasmas to industrial processing and manufacturing in nonsemiconductor market areas. The applications include hard coatings for wear and corrosion treatment of tools and components, thin film deposition for optical devices, and many others. Processes include plasma spraying, plasma nitriding, plasma polymerization and cross-linking, plasma-enhanced chemical vapor deposition (PECVD), magnetron sputtering sources, ion implantation techniques such as plasma source ion implantation (PSII), processes based on metal vapor vacuum arc (MEVVA) technology, and others.

Current Research and Development (R&D)

R&D Goals and Challenges

There is a need to refine and improve existing surface engineering techniques and to develop new techniques to serve an explosive growth of applications such as nanoscale devices, high-performance materials for aerospace, medical use, established large-scale heavy manufacturing, emerging high-technology manufacturing, and many other areas. An important component of this need relates to the environmental impact of the processing.

Related R&D Activities

U.S./international. The market for surface engineering techniques has been growing rapidly for the last three decades. It has been estimated that by 1994 (5 years ago) more than \$40B in surface engineering R&D had been invested collectively by North America, Japan, and Western Europe (*Chem. Eng.*, April 1994). In Germany alone, more than 1000 new surface engineering companies were established from 1990 to 1994.

Recent Successes

Plasma spraying. Plasma spray technology is a relatively mature technology that is beginning to benefit from fusion science and technology. For example, plasma spraying technology/modeling is one of the four major thrust areas in the Engineering Research Center for Plasma-Aided Manufacturing at the University of Wisconsin.

Plasma nitriding. Plasma nitriding, also a relatively mature technology, has its roots in the gas nitriding processes developed by the chemical engineering community. Although there has not been a great deal of interaction between the plasma nitriding and fusion community, industrial plasma nitriders are very much interested in joint R&D with the fusion community, particularly in the area of PECVD.

PECVD. PECVD offers the potential for high deposition rates at reduced processing temperatures. Experimental and modeling techniques developed in fusion science programs are having a large impact on the deposition of diamond and diamondlike carbon coatings on machine tool components, biomaterials, sensors, heat sinks, X-ray windows, and many other areas. Some of the emerging applications are in mass market, consumer products, such as the recently released DLC-coated razor blades from Gillette.

PSII. PSII is a nonline-of-sight technique for industrial surface engineering that was developed as a direct outgrowth of fusion technology research. First developed in 1986, this process has spawned more than 55 groups around the world to date (Fig. 1). A key factor in the development of PSII involved collaboration between university, industry, and fusion scientists at Los Alamos National Laboratory (Fig. 2), which was formalized initially by a Department of Energy Cooperative Research and Development Agreement, followed by the NIST/ATP program.

Metal MEVVA. Another direct spin-off of the fusion program is the MEVVA surface modification technology developed at Lawrence Berkeley Laboratory. This technology offers the possibility of performing high-throughput ion implantation of targets with ion species that include most of the periodic table elements. As an example of the synergisms that are developing within the plasma processing community, there is at present a very active program under way to combine the benefits of PSII and MEVVA technology.

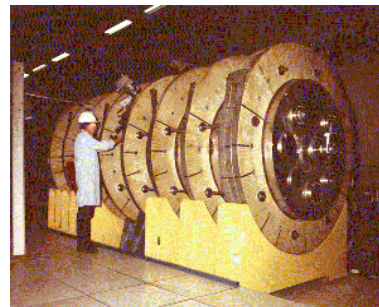
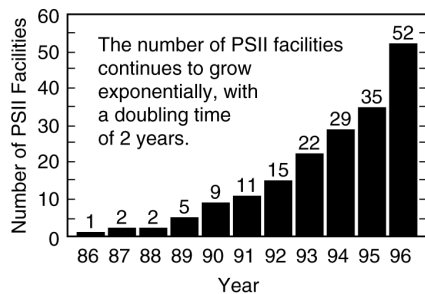

Fig. 1. Worldwide growth of PSII facilities.

Fig. 2. The worlds' largest PSII system.

Anticipated Contributions Relative to Metrics

	Supplier type	Primary market
Diagnostics for industrial plasma processing Langmuir probes and microwave interferometers	Subsystems	Generic
MEVVA technology ISM Company Technologies	Systems, services	Generic, but mostly nonsemiconductor
PECVD Applied Science and Technology (ASTeX) PMT	Systems Systems	Generic Generic
Plasma immersion ion implantation AEA Harwell spin-off company ANSTO/ANSTO spin-off, Australia Diversified Technologies, Boston, Mass. Empire Hard Chrome, Chicago, Ill. Ionex, Traverse City, Mich. Northstar Research, N.M. Panasonic PVI, Calif. Varian Extrion a-machine	Systems Systems Systems/modulators Services Systems/services Systems/modulators Systems/in-house manufacturing Company Systems	Generic Tribology Generic Automotive, die casting industry Automotive Generic Microelectronics, tribology Aerospace, microelectronics, optical coatings Microelectronics

Proponents' and Critics' Claims

Proponents think that plasma surface modification provides an environmentally friendly approach to rapidly expanding industrial needs in a very broad array of applications. In some emerging high-technology areas such as nanoscale device, plasma processing technology is the *only* currently available economically viable approach. A systematic science-based, multidisciplinary approach will continue to transform plasma processing from an empirical technology to an engineering technology.

Critics claim that industrial plasma technology is largely empirically based rather than science based and is therefore a risky technology for scale-up and application to new areas. Manufacturers are satisfied with their well-established nonplasma-based processes. Plasma processing is viewed by manufacturers as too costly.

N-3. ENVIRONMENT

Description

One of the most pressing concerns of our times is safeguarding the quality of our environment for present and future generations. Past practices have left a legacy of accumulated hazardous waste and pollution at many sites that must now be remedied. In addition, a critical challenge exists to prevent or significantly reduce continued generation of waste and pollution that can adversely affect the environment. Some examples include the cleanup of Department of Energy (DOE) sites involved in the nuclear weapons program, cleanup of Environmental Protection Agency (EPA) superfund sites resulting from past industrial and Department of Defense (DOD) operations, reduction of landfills and water pollution from industrial and municipal sources, and reduction or elimination of emissions into the atmosphere that can be harmful to people or the climate. The ultimate development of fusion energy will, of course, significantly reduce or eliminate many of the present waste streams and pollution currently associated with fossil fuel and nuclear fission power plants. However, in the interim, much of the knowledge gained in plasmas and the associated technologies developed to generate, control, and monitor plasmas can have a significant beneficial impact on our environmental needs.

Status

The United States is currently involved in what has been billed as the largest civil works project in its history, the cleanup of nuclear weapons production sites at Hanford, Savannah River, Oak Ridge, and other locations. Estimated cleanup costs exceed \$40B. Expenditure of additional billions is being mandated by the EPA to clean up superfund sites. Tightening of clean water and clean air regulations is causing an increasing investment by DOE, DOD, and commercial enterprises to meet the challenge. Much of the present expenditure on environmental cleanup and pollution prevention is for application of currently available methods and technologies. However, an increasing investment is beginning to be made in research and development (R&D) to find innovative new solutions to environmental problems. Two applied research programs are DOE's Environmental Management Science Program (EMSP) with a current budget of \$191M and the joint DOE/DOD Strategic Environmental Research and Development Program (SERDP) with a FY 1998 appropriation of \$61M. In addition, DOE Environmental Management funds a number of focus areas that are also investing in new technology development. Some of this funding supports plasma technologies and fusion energy spin-offs that have immediate near-term environmental applications. These technologies include thermal plasma arcs, nonthermal plasma chemistry methods, plasma-aided waste characterization and pollution monitoring, and advanced diagnostics for process control and monitoring. Currently there is no long-term investment in plasma science research to more fully exploit the potential of the plasma state for environmental needs.

Current Research & Development (R&D)

R&D Goals and Challenges

- Develop technologies to reduce risks and costs for remediation of mixed radioactive wastes.
- Develop improved thermal remediation technologies for faster throughput, reduced emissions, and lower cost waste processing.
- Research nonthermal processes for more efficient, targeted destruction of hazardous air pollutants (HAPs) such as volatile organic compounds (VOCs) and for nondestructive decontamination of surfaces.
- Develop technologies for cleaning fine particulate emissions and other HAPs from current thermal processes in industry, power production, and burning of wastes.
- Develop new processes and technologies for eliminating SO_x and NO_x emissions from vehicle and stationary sources.
- Develop more sensitive and accurate continuous emissions monitors of pollution such as metals, dioxins, furans, and other hazardous pollutants.
- Develop technologies to reduce and/or eliminate CO₂ and other greenhouse gas emissions and research possible CO₂ sequestering technologies.

Related R&D Activities

Many government agencies and commercial companies have programs and goals to reduce environmental pollution. The DOE Office of Industrial Technology has roadmaps for several industries including aluminum, steel, glass, and chemicals primarily to improve energy efficiencies, but they would also, as a consequence, reduce pollution. The automobile manufacturers have major efforts to develop environmentally cleaner cars. Spin-off fusion energy technologies can contribute to all these efforts.

Recent Successes

- Initial demonstration of plasma arc technology for vitrification of DOE mixed waste.
- Electron beam plasmas demonstrated for efficient destruction of dilute VOCs.
- Initial demonstration of compact plasma arc device (plasmatron) for reforming hydrocarbon fuels to cleaner burning hydrogen gas, (could be implemented on cars and other vehicles).
- New robust temperature measurement capability achieved inside harsh furnace environments with the application of fusion energy developed millimeter-wave receivers.
- Microwave plasmas developed for continuous emissions monitoring of hazardous metals.

Budget

- DOE-EMSP: current budget is \$191M.
- DOE/DOD: SERDP FY 1998 = \$61M.
- DOE Environmental Management funds several focus areas in new technology development.

Anticipated Contributions Relative to Metrics

Metrics

The EPA and DOE Environmental Management largely define the environmental needs which motivate and guide the R&D necessary to achieve those needs. There is a close connection between the research and the intended application. An end user is generally identified before research is committed. Plasma technologies and fusion energy spin-offs are supported when it is clear that a short-term development will pay off.

Near Term <5 years

Incremental improvements will be made in arc processes, plasmatrons, plasma-aided monitoring technologies, and application of advanced diagnostics to environmental processes. Conventional processes will benefit from improved monitoring and control technologies. Some of these technologies will be commercialized.

Midterm 5–20 years

Advanced applications of plasmas to waste remediation will be developed. The plasma state will be used more to destroy hazardous materials rather than just as a source of heat as in near-term arc processes. New atmospheric plasma generation technologies will be developed with high throughput and efficient operation. Multistage plasma waste processing systems will be developed. Portable units and in situ vitrification technologies will be commercialized. More universal plasma waste processing capability will be achieved.

Long Term >20 years

Continued advancement will be made toward universal plasma waste processing systems. Neutron transmutation of radioactive wastes, using fusion neutron sources, will be a topic of research to reduce controversial requirements for long-term radioactive storage.

Proponents' and Critics' Claims

Proponents think that plasma science can make a significant contribution to current and future environmental needs. A physics perspective is needed in the environmental cleanup effort, which is currently dominated by chemical engineers. Breakthrough advances may be possible for some of our most pressing environmental problems.

Critics claim that plasma research would be more long-term and environmental remedies are needed now. Few companies would be willing to accept novel new plasma technologies with unknown track records.

N-4. MEDICAL APPLICATIONS

Description

The cost and quality of medical care is one of the most pressing concerns for the nation. New medical technology based on knowledge derived from the fusion programs and plasma science is simultaneously reducing the cost of health care and increasing efficacy. Spin-offs to industry already include a system for treatment of stroke, based on expertise in lasers, optics, and modeling of interactions of lasers and matter. Another spin-off is the use of miniaturized X-ray sources in preventing recurrence of coronary blockage after balloon angioplasty. A third example is the recent advance in magnetic resonance imaging (MRI) magnet technology that took advantage of superconducting coils developed by the fusion and high-energy physics programs. The large computer codes developed to model radiation transport and laser-matter interactions are now being applied to model laser interactions with human tissue. Therapy of well-defined tumors by proton or heavy-ion therapy (hadrontherapy) has the advantage that the energy deposition concentrates at the Bragg peak, just before the ion stops. This enables a more precise treatment of cancers, while minimizing damage to tissue around the tumor. Ions as heavy as argon have been used in clinical trials.

Status

At present there are a variety of projects under way at national laboratories, universities, and industry that are addressing medical applications as spin-offs of plasma physics research and related technologies. Most of these projects have direct ties to the fusion program, sharing personnel and infrastructure. An increasing awareness of the needs of the medical community is resulting in a sharp increase in the number of projects. Dozens of plasma-physics-related medical technology projects have already transferred to industry, and several are currently in human trials with many in earlier stage trials.

Heavy-ion therapy. Accelerator laboratories, working in conjunction with hospitals, are giving increased attention to heavy-ion therapy. An existing accelerator is being used at GSI Darmstadt, Germany, and a new facility at Chiba, Japan, was built specifically to test and develop heavy-ion therapy. The pioneering work was done at Lawrence Berkeley National Laboratory (LBNL) and the University of California–San Francisco.

Progress to date has largely been funded through indirect channels, which severely limit development.

Current Research & Development (R&D)

R&D Goals and Challenges

- Develop technologies to reduce medical device cost. This could include device manufacturing, new materials, cheaper materials, and new diagnostics.
- Develop plasma-mediated tissue ablation that is economical and generates minimal collateral damage.
- Develop new imaging modalities that improve resolution or offer functional imaging capabilities.
- Develop miniature X-ray sources and detectors that can be inserted through minimally invasive catheters.
- Apply plasma processing techniques to manufacture new minimally invasive medical devices.
- Develop compact and sensitive mass spectrometers for analyzing exhaled gas.
- Develop microwave and radio frequency (rf) techniques for cancer treatment.
- Develop plasma sterilization techniques.
- Develop heavy-ion beams based on fusion derived injectors, with raster scanning in 2-D to control beam deposition.

Related R&D Activities

Many universities, government agencies [National Institutes of Health (NIH), Department of Energy (DOE), and NIST-ATP] and commercial companies have programs to improve health care and reduce medical costs. The search for new medical devices for diagnostics and treatment is ongoing. Spin-offs from the plasma science community can contribute to all these efforts.

Recent Successes

A joint venture between a General Atomic spin-off and Toshiba America will supply the next-generation MRI magnets that were originally developed by the fusion program. At Lawrence Livermore National Laboratory (LLNL) a micro-impulse radar (MIR) imaging technique offers the possibility to rapidly and noninvasively detect trauma, strokes, and hematomas. These portable microwave devices are complementary to traditional MRI and computerized tomography (CT) scans and have a projected market of \$200M per year. Plasma-mediated ablation using ultra-short lasers developed from fusion (<10 ps) offer a breakthrough by enabling precision cuts without damaging surrounding tissue. Also at LLNL, a minimally invasive technique called endovascular photoacoustic recanalization has been developed to treat stroke, which affects 700,000 people per year in the United States. This took advantage of laser-matter interaction codes developed as part of the fusion program. A heart disease treatment technology, also codeveloped with industry by LLNL, is an X-ray catheter that is used in conjunction with traditional balloon angioplasty as a treatment to prevent arterial restenosis (reclogging of the arteries due to tissue regrowth after balloon angioplasty treatment).

Anticipated Contributions Relative to Metrics

Metrics

Historically, NIH has defined the medical needs and guided the R&D necessary to fulfil these needs. More recently, DOE has recognized the potential of fusion-derived technology to improve medical care and has provided a low level of support for device development. Plasma technologies and fusion energy spin-offs are supported when it is clear that a short-term development will pay off. Ultimately, the metrics will be the number of successfully commercialized devices and the number of people whose lives are favorably affected.

Near Term <5 years

The near-term focus is on the successful commercialization of the technologies that are presently identified. Applying these plasma science technologies will lead to the development of new medical devices and possible reduction in manufacturing costs of existing devices. Demonstration of heavy-ion beam systems.

Midterm 5–20 years

As the issues of interaction with industry and the commercialization of medical technology continue to be resolved, the focus will shift to a primary emphasis on research that can further extend the contributions to the medical community. Plasma processing will play an important role in the development of minimally invasive devices that can be used in catheter-based procedures. Improvements in medical imaging will rely on a new generation of detectors and systems, both of which can benefit from plasma science.

Long Term >20 years

The ultimate goal is the development of new noninvasive diagnostics and therapies that reduce costs and save lives. The early detection of disease and efficient treatment will go a long way to reducing health care costs and patient suffering.

Proponents' and Critics' Claims

Proponents say that physics perspective is needed in the medical device community, which is currently dominated by engineers. Technology and physics knowledge gained through plasma research can play an important role in current and future medical device development and manufacturing. Proponents claim that hadrontherapy should provide a much higher level of cancer control with fewer side effects.

Critics say that plasma science plays a support role in most medical devices. It is unlikely that the next MRI tool is going to come out of plasma research. Critics think that it is foolish to spend money on unproven technology, and needs can be met with more conventional and less costly methods.

N-5. PLASMA PROPULSION

Description

Plasma-based propulsion systems for spacecraft are receiving increased and considerable interest. There are numerous working devices and innovative concepts. Thrust is generated by using electrical energy to accelerate a propellant. The accelerated species is generally ions, with plasma neutralization subsequent to acceleration. Plasma propulsion technologies include Arcjets, Ion Thrusters, Hall Thrusters, Magneto-Plasma-Dynamic Thrusters, and radio frequency (rf) driven plasma thrusters, with concepts incorporating the possibilities for either pulsed or continuous operation. Their applications include “station keeping” for geosynchronous earth orbit (GEO), drag compensation for low earth orbit (LEO), and high-specific-impulse thrust for interplanetary and deep space missions. Plasma propulsion can provide higher specific impulse [Isp (thrust/mass flow)] than conventional chemical propulsion because of the high speeds attainable by plasma. The higher specific impulse means that a spacecraft using plasma propulsion can perform a mission with less propellant mass than with conventional chemical propulsion. Note that the number of satellites is rapidly growing, particularly for LEO, which is driven by the worldwide needs for communication.

There are strong areas of overlap between the fusion research community and the plasma propulsion community. Plasma concepts of flow in crossed electric and magnetic fields are common both to electric propulsion devices and collisionless plasma behavior in magnetic fusion devices. These systems also use many of the same technologies that are required for fusion, with many common diagnostic techniques.

Status

Several plasma-based systems are in use or planned for future missions. The Russian space program has used Hall thrusters for more than 25 years. Hall thrusters are now in limited use on U.S. and European satellites, but it is anticipated that the planned 288 satellite Teledesic commercial satellite system will employ Hall thrusters. In October 1998, a Russian-made Electron Propulsion Demonstration Module (EPDM) Hall thruster (Fig. 1) was used to boost the orbit of the U.S. STEX satellite. An ion engine is in use on the Deep Space 1 probe (Fig. 2), which was launched in October 1998. A novel rf driven plasma propulsion system (VASIMR concept), which is based on a magnetic mirror configuration (Fig. 3), has been proposed for use in human exploration of the solar system.

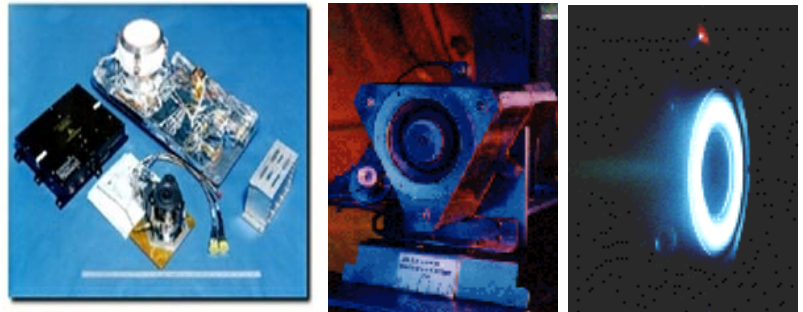

Fig. 1. Russian-made TAL D-55 EPDM Hall thruster.

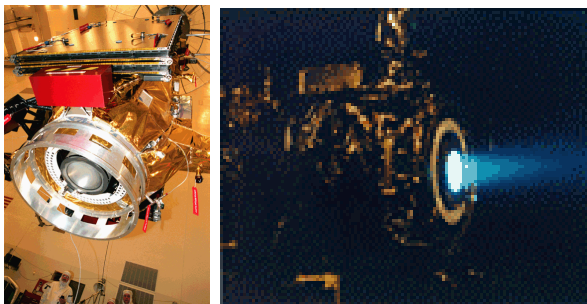

Fig. 2. Ion engine for Deep Space 1.

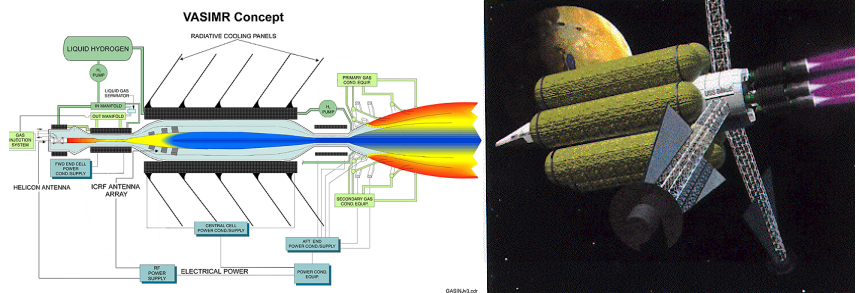

Fig. 3. VASIMR concept using rf heating of hydrogen in an end loss mirror configuration.

Current Research and Development (R&D)

R&D Goals and Challenges

The current work ranges from basic to applied R&D. The time scale for the research ranges from near to long term. Detailed diagnostic measurements and model development on devices currently in use (i.e., Hall thrusters) can lead to optimized designs for immediate applications. Theoretical and experimental work can provide important groundwork for new concepts (i.e., VASIMIR and others). Technology advances will be required to provide compact rf power supplies and reduced-weight, high-temperature, superconducting magnets.

Related R&D Activities

In the United States, several National Aeronautics and Space Administration (NASA) facilities, Department of Energy (DOE) laboratories, and university centers have ongoing work in plasma propulsion. These include but are not limited to NASA [Johnson, Lewis, Marshall, Jet Propulsion Laboratory (JPL)], Department of Defense (Naval Research Laboratory, BMDO), DOE (Oak Ridge National Laboratory, Princeton Plasma Physics Laboratory, Lawrence Livermore National Laboratory, Brookhaven National Laboratory) and universities (Maryland, Wisconsin–Madison, Stanford, Michigan, Penn State, Alabama–Huntsville) along with numerous programs in the aerospace industry.

The Russian and European space programs and plasma physics laboratories have active programs in plasma propulsion.

Recent Successes

Ion propulsion systems have recently been used in NASA missions:

- EPDM Hall thruster (Russian TAL D-55) on the STEX satellite.
- An ion engine is in use on Deep Space 1.

Budget

There is currently no direct Office of Fusion Energy Sciences (OFES) funding in this area.

Anticipated Contributions Relative to Metrics

Metrics

OFES and the National Science Foundation (NSF) are the stewardship agencies for Plasma Science and Technology. Other agencies have supported electric propulsion for space applications, but research conducted elsewhere has been highly performance and mission driven. Consequently, compared to plasma programs supported within OFES, there is less emphasis on diagnostics and basic science, which are the building blocks for understanding and innovation. Applying plasma expertise developed within the fusion research program to space propulsion, fusion scientists and engineers should be poised to contribute importantly to plasma-based thruster programs in government and industry. This is already happening, as scientists within the fusion program are proposing propulsion concepts such as the NASA/ORNL VASIMR or the PPPL segmented Hall thrusters. Work in this area provides high visibility to the fusion program, based on the interest of the public, Congress, and the media in new technological “spin-offs.” It increases the “spin-in” of new technology into the fusion program from NASA and industrial programs.

Near Term <5 to 10 years

- Provide diagnostic expertise and enhance current theoretical models.
- Develop new concepts.

Midterm 10–20 years

- Design and build new electric/plasma thrusters.
- Continue to develop new concepts.

Science

- Establish a knowledge base and a fundamental understanding of key phenomena in electric and plasma propulsion.
- Provide a new means to explore the universe.

Proponents’ and Critics’ Claims

Proponents

- Science and technology developed for fusion are well matched to the requirements for electric propulsion and have been underutilized by the aerospace community.
- NASA welcomes involvement from the fusion, plasma science, and technology communities.
- Both spin-offs and spin-ins will benefit the fusion community.
- NASA- and industry-funded research helps maintain a critical mass of expertise.
- NASA and industry cannot maintain large staffs of plasma experts and thus can cost effectively draw on expertise residing in the fusion community.

Critics

- NASA has this role; DOE should concentrate on other priorities.
- Coordinated research between industry and government is “corporate welfare.”
- University and national laboratory research are disconnected from industry needs.
- National laboratory research is too expensive for industry.

References

1. R. T. Myers, Sverdrup Technology, Inc. (now NYMA Corp.), “Electromagnetic Propulsion for Spacecraft,” AIAA 93-1086.
 2. L. K. Rudolph and D. Q. King, “Electromagnetic Thrusters for Spacecraft Prime Propulsion,” AIAA 84-1446, AIAA/SAE/ASME 20th Joint Propulsion Conference, June 11–13, 1984.
 3. “Ion Propulsion for Spacecraft,” NASA Lewis, 1977.
 4. Sovey et al., “Development Status of the NASA 30-cm Ion Thruster and Power Processor,” NASA TM 106740.
-

ACRONYMS AND ABBREVIATIONS

ANL	Argonne National Laboratory
APEX	Advanced Power Extraction
APT	accelerator production of tritium
ARIES	Advanced Reactor Innovation and Evaluation Studies
ASCI	Advanced Strategic Computing Initiative
AT	Advanced Tokamak
BES	Office of Basic Energy Sciences (DOE)
BINF	Budker Institute of Nuclear Physics
BNCT	Boron Neutron Capture Therapy
BPX	Burning Plasma Experiment
BPX-AT	Burning Plasma Experiment–Advanced Tokamak
CAT	Compact Auburn Torsatron
CDX-U	Current Drive Experiment–Upgrade
CEX	charge exchange
CFD	computational fluid dynamics
CHER	charge exchange recombination spectroscopy
CICC	cable-in-conduit conductor
CIT	Compact Ignition Tokamak
CLR	coherent laser radar
COE	cost of electricity
CRADA	Cooperative Research and Development Agreement
CSMC	CS model coil
CT	compact toroid
CT	computerized tomography
CTX	compact toroid experiment
CW	continuous wave
D&D	decontamination and decommissioning
DARPA	Defense Advanced Research Projects Agency
D-D	deuterium-deuterium
DEMO	demonstration reactor
DIF-CEA	DIF–Commissariat a l’Energie Atomique
DIID	Doublet III-D tokamak experiment at General Atomics
DLC	diamondlike carbon
DN	double null
DOD	Department of Defense
DOE	Department of Energy
DP	Office of Defense Programs (DOE)
DPSSL	diode-pumped solid-state laser
DS	dispersion strengthened
D-T	deuterium-tritium
DTST	deuterium-tritium spherical tokamak
EC	electron cyclotron
ECRH	electron cyclotron resonance heating
ECW	electron cyclotron wave
EDA	engineering design activity
EDM	electrodischarge machine
ELM	edge-localized mode
EOS	equation of state
EMSP	Environmental Management Science Program
EPDM	Electron Propulsion Demonstration Module
ER	Office of Energy Research (DOE)

ET	electric tokamak
ETF	engineering test facility
ETR	engineering test reactor
EUV	extreme ultraviolet
FDA	U.S. Food and Drug Administration
FESAC	Fusion Energy Sciences Advisory Committee
FIRE	Fusion Ignition Research Experiment
Flibe	fluorine-lithium-beryllium molten salts (Li_2BeF_4)
FM	frequency modulated
FPD	flat panel display
FRC	field-reversed configuration
FW	first wall
FY	fiscal year
GA	General Atomics
GDT	Gas Dynamic Trap
GDTNS	Gas Dynamic Trap Neutron Source
GEO	geosynchronous earth orbit
GILMM	grazing incidence liquid metal mirrors
GIMM	grazing incident metal mirrors
HAP	hazardous air pollutant
HED	high energy density
HID	heavy ion driver
HIF	heavy ion fusion
HIT	Helicity Injected Torus
HMO	health maintenance organization
HSX	Helically Symmetric Experiment
HTS	high-temperature superconductor
IAEA	International Atomic Energy Agency
ICF	inertial confinement fusion
ICH	ion cyclotron heating
ICP	inductively coupled plasma
ICRF	ion cyclotron range of frequency
ICRH	ion cyclotron resonance heating
IEA	International Energy Agency
IFE	inertial fusion energy
IFMIF	International Fusion Materials Irradiation Facility
INEEL	Idaho National Engineering and Environmental Laboratory
IRE	Integrated Research Experiment
IRE	internal relaxation event
ISX-B	Impurities Study Experiment-B
ITER	International Thermonuclear Experimental Reactor
JAERI	Japan Atomic Energy Research Institute
JET	Joint European Torus
JPL	Jet Propulsion Laboratory
KSTAR	tokamak in Korea
LBNL	Lawrence Berkeley National Laboratory
LDX	Levitated Dipole Experiment
LEO	low earth orbit
L-H	low-to-high confinement transition in a tokamak
LHCD	lower hybrid current drive
LHD	Large Helical Device
LLE	Laboratory for Laser Energetics
LLNL	Lawrence Livermore National Laboratory
LLUMC	Loma Linda University Medical Center

LMJ	laser megajoule
LSX	Large S Experiment
LTE	local thermodynamic equilibrium
LTS	low-temperature superconductor
MAST	Mega-Amp Spherical Tokamak
MCF	magnetic confinement fusion
MEVVA	metal vapor vacuum arc
MFE	magnetic fusion energy
MHD	magnetohydrodynamic
MIR	micro-impulse radar
MPP	massively parallel processing
MIT	Massachusetts Institute of Technology
MRI	magnetic resonance imaging
MSE	motional stark effect
MST	Madison Symmetric Torus
MTF	magnetized target fusion
NASA	National Aeronautics and Space Administration
NBI	neutral beam injection
NCS	negative central shear
NCSX	National Compact Stellarator Experiment
ND	naturally diverted
NIF	National Ignition Facility
NIFS	Nagoya Institute for Fusion Science
NIH	National Institutes of Health
NRL	Naval Research Laboratory
NSF	National Science Foundation
NSO	next-step option
NSTE	National Spherical Tokamak Experiment
NSTX	National Spherical Torus Experiment
NTC	Nova Technical Contract
OFES	Office of Fusion Energy Sciences (DOE)
ORNL	Oak Ridge National Laboratory
PBFA	Plasma Beam Facility-A
PCAST	President's Committee of Advisors on Science and Technology
PECVD	plasma-enhanced chemical vapor deposition
PEP	pellet-enhanced performance
PET	positron-emission tomography
PF	poloidal field
PFC	plasma-facing component
PIC	particle-in-cell
PIII	plasma immersion ion implantation
PMI	plasma-materials interaction
PMR	palladium membrane reactor
PNNL	Pacific Northwest National Laboratory
PoP	proof of principle
PPPL	Princeton Plasma Physics Laboratory
PVD	physical vapor deposition
QA	quasi-axisymmetry
QHS	quasi-helically symmetry
QO	quasi-omnigeneity
QOS	quasi-omnigenous stellarator
RC	reduced cost (ITER)
rf	radio frequency
RFP	reversed-field-pinch

RFX	(facility in Italy)
RH	remote handling
RHEPP	repetitive high-energy pulsed power
RIE	reactive ion etching
RIM	robotics and intelligent machines
RM	Richtmyer-Meshkov
RMF	rotating magnetic fields
RS	reversed shear
RT	Rayleigh-Taylor
S/B	shield/blanket
SAGBO	strain accelerated grain boundary oxidation
SBIR	Small Business Innovation Research
SBS	stimulated Brillouin scattering
SERDP	Strategic Environmental Research and Development Program
SLCC	superconductor laced copper conductor
SNL	Sandia National Laboratories
SNS	Spallation Neutron Source
SOL	scrape-off layer
SRS	stimulated Raman scattering
SSP	Scientific Simulation Plan
SSPX	Sustained Spheromak Physics Experiment
SSTR	steady-state tokamak reactor
SSX	Swarthmore Spheromak Experiment
ST	spherical tokamak
STAR	Science and Technology Advanced Reactor
START	Small Tight Aspect Ratio Tokamak
STEX	U.S. satellite
TCS	translation, confinement, and sustainment
TEXTOR	Tokamak Experiment for Technology Oriented Research
TF	toroidal field
TFTR	Tokamak Fusion Test Reactor
TPE-RX	(facility in Japan)
TPL	Tritium Processing Laboratory
TRAP	tokamak refueling by accelerated plasmoids
TSTA	Tritium Systems Test Assembly
UCSD	University of California–San Diego
UCSF	University of California–San Francisco
UKAEA	United Kingdom Atomic Energy Authority
UV	ultraviolet
UW	University of Wisconsin
V&V	verified and validated
VASIMIR	rf-driven plasma propulsion system
VNS	volumetric neutron source
VOC	volatile organic compound
W7-AS	German Wendelstein 7-AS stellarator experiment
W7-X	Wendelstein 7-X
WFO	Work for Others